

SPLIT-TYPE, AIR CONDITIONERS
 SPLIT-TYPE, HEAT PUMP AIR CONDITIONERS
 FLOOR AND CEILING TYPE AIR CONDITIONERS
 FLOOR TYPE, HEAT PUMP AIR CONDITIONERS

Revision D:

• MXZ-5A100VA - E has been added.

Please void OBT06 REVISED EDITION-C.

No. OBT06
 REVISED EDITION-D

SERVICE TECHNICAL GUIDE

Wireless type Models

MSC-CA•VB - E

MSC-CB•VB - E

MSC-GA•VB - E

Multi system type Models

Wireless type Models

MS-GA•VB - E

MSH-CA•VB - E

MSH-CB•VB - E

MSH-GA•VB - E

MSZ-CA•VB - E

MSZ-FA•VA - E

MSZ-GA•VA - E

MSZ-CB•VA - E

MSZ-HA•VA - E

MSZ-GB•VA - E

Inverter-controlled multi system type Models

Wireless type Models

MCF-GA•VB - E

MCFH-GA•VB - E

MFZ-KA•VA - E

• MU-GA•VB - E

• MUH-GA•VB - E

• MUX-A•VB - E

• MU-GA•VB - E

• MUH-GA•VB - E

• MUZ-CA•VB - E

• MUZ-FA•VA - E

• MUZ-FA•VAH - E

• MUZ-GA•VA - E

• MUZ-GA•VAH - E

• MUZ-HA•VA - E

• MUZ-GB•VA - E

• MXZ-A•VA - E

• MUCF-GA•VB - E

• MUCFH-GA•VB - E

CONTENTS

1. MSC MICROPROCESSOR CONTROL.....	6
2. MS MICROPROCESSOR CONTROL	15
3. MSH MICROPROCESSOR CONTROL.....	26
4. MSZ-CA MICROPROCESSOR CONTROL.....	39
5. MSZ-FA MICROPROCESSOR CONTROL	54
6. MSZ-GA, MSZ-CB MICROPROCESSOR CONTROL	72
7. MCF MICROPROCESSOR CONTROL.....	100
8. MCFH MICROPROCESSOR CONTROL	106
9. MFZ MICROPROCESSOR CONTROL	115
10. MSZ-HA MICROPROCESSOR CONTROL	127
11. MSZ-GB MICROPROCESSOR CONTROL.....	137
12. MXZ MICROPROCESSOR CONTROL	150

Revision D: • MXZ-5A100VA - [E] and MXZ-4A80VA - [E2] have been added.

Revision C: • MXZ-2A30VA - [E] and MXZ-2A40VA - [E2] have been added.

Revision B: • MSZ-CB•VA - [E] has been added.
• MSZ-HA•VA - [E] has been added.
• MSZ-GB•VA - [E] has been added.
• MXZ-2A40/52VA - [E] has been added.

Revision A: • MFZ-KA•VA - [E] has been added.

1. MSC MICROPROCESSOR CONTROL.....6

Indoor unit models

Outdoor unit models

MSC-CA20VB	MSC-CB20VB	MSC-GA20VB	MU-GA20VB	MUH-GA20VB	MUX-2A28VB
MSC-CA25VB	MSC-CB25VB	MSC-GA25VB	MU-GA25VB	MUH-GA25VB	MUX-2A59VB
MSC-CA35VB	MSC-CB35VB	MSC-GA35VB	MU-GA35VB	MUH-GA35VB	MUX-3A60VB
					MUX-2A70VB
					MUX-3A63VB
					MUX-4A73VB

1-1. COOL OPERATION.....6
1-2. DRY OPERATION7
1-3. FAN OPERATION.....8
1-4. HEAT OPERATION8
1-5. "I FEEL CONTROL" OPERATION9
1-6. INDOOR FAN MOTOR CONTROL11
1-7. AUTO VANE OPERATION11
1-8. TIMER OPERATION.....12
1-9. EMERGENCY / TEST OPERATION13
1-10. OUTDOOR UNIT ACTUATOR CONTROL14

2. MS MICROPROCESSOR CONTROL15

Indoor unit models

Outdoor unit models

MS-GA50VB	MU-GA50VB
MS-GA60VB	MU-GA60VB
MS-GA80VB	MU-GA80VB

2-1. "I FEEL CONTROL" OPERATION15
2-2. COOL OPERATION.....18
2-3. DRY OPERATION19
2-4. FAN OPERATION.....19
2-5. INDOOR FAN MOTOR CONTROL19
2-6. AUTO VANE OPERATION19
2-7. TIMER OPERATION.....22
2-8. EMERGENCY / TEST OPERATION23
2-9. EXPANSION VALVE CONTROL (LEV CONTROL)24
2-10. FUNCTION OF SOFT START RELAY25

3. MSH MICROPROCESSOR CONTROL.....26

Indoor unit models

Outdoor unit models

MSH-CA50VB	MSH-GA50VB	MUH-GA50VB
MSH-CB50VB	MSH-GA60VB	MUH-GA60VB
	MSH-GA80VB	MUH-GA80VB

3-1. "I FEEL CONTROL" OPERATION26
3-2. COOL OPERATION.....32
3-3. DRY OPERATION32
3-4. HEAT OPERATION32
3-5. INDOOR FAN MOTOR CONTROL32
3-6. AUTO VANE OPERATION33
3-7. TIMER OPERATION.....35
3-8. EMERGENCY / TEST OPERATION36
3-9. EXPANSION VALVE CONTROL (LEV CONTROL)37
3-10. FUNCTION OF SOFT START RELAY38

4. MSZ-CA MICROPROCESSOR CONTROL	39
Indoor unit models Outdoor unit models	
MSZ-CA25VB MUZ-CA25VB	
MSZ-CA35VB MUZ-CA35VB	
4-1. "I FEEL CONTROL" OPERATION	39
4-2. AUTO CHANGE OVER --- AUTO MODE OPERATION.....	44
4-3. COOL OPERATION.....	45
4-4. DRY OPERATION	45
4-5. HEAT OPERATION	45
4-6. INDOOR FAN MOTOR CONTROL	46
4-7. AUTO VANE OPERATION	46
4-8. TIMER OPERATION.....	47
4-9. EMERGENCY / TEST OPERATION	48
4-10. INVERTER SYSTEM CONTROL	49
4-11. OPERATION FREQUENCY CONTROL OF OUTDOOR UNIT.....	51
4-12. EXPANSION VALVE CONTROL (LEV CONTROL).....	52
5. MSZ-FA MICROPROCESSOR CONTROL	54
Indoor unit models Outdoor unit models	
MSZ-FA25VA MUZ-FA25VA MUZ-FA25VAH	
MSZ-FA35VA MUZ-FA35VA MUZ-FA35VAH	
5-1. COOL OPERATION.....	55
5-2. DRY OPERATION	56
5-3. HEAT OPERATION	56
5-4. AUTO CHANGE OVER --- AUTO MODE OPERATION.....	58
5-5. INDOOR FAN MOTOR CONTROL	59
5-6. OUTDOOR FAN MOTOR CONTROL	59
5-7. AUTO VANE OPERATION	59
5-8. i-see CONTROL OPERATION.....	61
5-9. AREA SETTING	62
5-10. PLASMA DUO OPERATION	64
5-11. AUTO FRONT PANEL	65
5-12. TIMER OPERATION	65
5-13. EMERGENCY / TEST OPERATION	66
5-14. INVERTER SYSTEM CONTROL	67
5-15. OPERATIONAL FREQUENCY CONTROL OF OUTDOOR UNIT.....	69
5-16. EXPANSION VALVE CONTROL (LEV CONTROL).....	70
6. MSZ-GA, MSZ-CB MICROPROCESSOR CONTROL	72
Indoor unit models Outdoor unit models	
MSZ-GA22VA MSZ-CB22VA	
MSZ-GA25VA MSZ-CB25VA MUZ-GA25VA MUZ-GA25VAH	
MSZ-GA35VA MSZ-CB35VA MUZ-GA35VA MUZ-GA35VAH	
6-1. COOL OPERATION.....	73
6-2. DRY OPERATION	74
6-3. HEAT OPERATION	74
6-4. AUTO CHANGE OVER --- AUTO MODE OPERATION.....	76
6-5. INDOOR FAN MOTOR CONTROL	77
6-6. OUTDOOR FAN MOTOR CONTROL	77
6-7. AUTO VANE OPERATION	77
6-8. TIMER OPERATION.....	79
6-9. EMERGENCY / TEST OPERATION	80
6-10. INVERTER SYSTEM CONTROL	81
6-11. OPERATIONAL FREQUENCY CONTROL OF OUTDOOR UNIT.....	83
6-12. EXPANSION VALVE CONTROL (LEV CONTROL).....	84

Indoor unit models Outdoor unit models
MSZ-GA50VA MUZ-GA50VA
MSZ-GA60VA MUZ-GA60VA
MSZ-GA71VA MUZ-GA71VA

6-13. COOL OPERATION86
6-14. DRY OPERATION87
6-15. HEAT OPERATION88
6-16. AUTO CHANGE OVER ... AUTO MODE OPERATION90
6-17. INDOOR FAN MOTOR CONTROL.....90
6-18. OUTDOOR FAN MOTOR CONTROL.....91
6-19. AUTO VANE OPERATION.....91
6-20. TIMER OPERATION94
6-21. EMERGENCY/TEST OPERATION95
6-22. INVERTER SYSTEM CONTROL95
6-23. OPERATIONAL FREQUENCY CONTROL OF OUTDOOR UNIT97
6-24. EXPANSION VALVE CONTROL (LEV CONTROL).....98

7. MCF MICROPROCESSOR CONTROL100

Indoor unit models Outdoor unit models
MCF-GA35VB MUCF-GA35VB
MCF-GA50VB MUCF-GA50VB
MCF-GA60VB MUCF-GA60VB

7-1. "I FEEL CONTROL" OPERATION100
7-2. COOL OPERATION.....103
7-3. DRY OPERATION103
7-4. FAN OPERATION.....103
7-5. AUTO VANE OPERATION103
7-6. TIMER OPERATION.....105
7-7. EMERGENCY / TEST OPERATION105

8. MCFH MICROPROCESSOR CONTROL106

Indoor unit models Outdoor unit models
MCFH-GA35VB MUCFH-GA35VB
MCFH-GA50VB MUCFH-GA50VB
MCFH-GA60VB MUCFH-GA60VB

8-1. "I FEEL CONTROL" OPERATION106
8-2. COOL OPERATION.....110
8-3. DRY OPERATION111
8-4. HEAT OPERATION.....111
8-5. AUTO VANE OPERATION.....111
8-6. TIMER OPERATION113
8-7. EMERGENCY / TEST OPERATION.....114

9. MFZ MICROPROCESSOR CONTROL.....115

Indoor unit models
MFZ-KA25VA
MFZ-KA35VA
MFZ-KA50VA

(As for outdoor units SUZ-KA25/35/50VA.TH and SUZ-KA25/35VAH.TH, refer to service manual OC322.)

9-1. COOL OPERATION.....117
9-2. DRY OPERATION.....117
9-3. HEAT OPERATION.....117
9-4. AUTO CHANGE OVER ... AUTO MODE OPERATION119
9-5. INDOOR FAN MOTOR CONTROL120
9-6. OUTDOOR FAN MOTOR CONTROL120
9-7. AUTO VANE OPERATION.....120
9-8. i-save OPERATION.....124
9-9. TIMER OPERATION.....125
9-10. EMERGENCY / TEST OPERATION126

10. MSZ-HA MICROPROCESSOR CONTROL	127
Indoor unit models Outdoor unit models	
MSZ-HA25VA MUZ-HA25VA	
MSZ-HA35VA MUZ-HA35VA	
10-1. COOL OPERATION.....	128
10-2. DRY OPERATION	128
10-3. HEAT OPERATION	129
10-4. INDOOR FAN MOTOR CONTROL	130
10-5. AUTO VANE OPERATION.....	131
10-6. TIMER OPERATION.....	133
10-7. EMERGENCY / TEST OPERATION	133
10-8. INVERTER SYSTEM CONTROL	134
10-9. OPERATIONAL FREQUENCY CONTROL OF OUTDOOR UNIT	136
11. MSZ-GB MICROPROCESSOR CONTROL	137
Indoor unit models Outdoor unit models	
MSZ-GB50VA MUZ-GB50VA	
11-1. COOL OPERATION.....	138
11-2. DRY OPERATION.....	139
11-3. HEAT OPERATION.....	139
11-4. AUTO CHANGE OVER ... AUTO MODE OPERATION	141
11-5. INDOOR FAN MOTOR CONTROL	141
11-6. OUTDOOR FAN MOTOR CONTROL	142
11-7. AUTO VANE OPERATION	142
11-8. TIMER OPERATION.....	144
11-9. EMERGENCY / TEST OPERATION.....	145
11-10. INVERTER SYSTEM CONTROL	145
11-11. OPERATIONAL FREQUENCY CONTROL OF OUTDOOR UNIT	147
11-12. EXPANSION VALVE CONTROL (LEV CONTROL).....	148
12. MXZ MICROPROCESSOR CONTROL	150
Outdoor unit models	
MXZ-2A30VA	
MXZ-2A40VA	
MXZ-2A52VA	
MXZ-3A54VA	
MXZ-4A71VA	
MXZ-4A80VA	
MXZ-5A100VA	
12-1. INVERTER SYSTEM CONTROL	150
12-2. EXPANSION VALVE CONTROL (LEV CONTROL)	153
12-3. OPERATIONAL FREQUENCY RANGE.....	159
12-4. HEAT DEFROSTING CONTROL	160
12-5. DISCHARGE TEMPERATURE PROTECTION CONTROL.....	161
12-6. REFRIGERANT RECOVERY CONTROL ON HEATING.....	161
12-7. OUTDOOR FAN CONTROL.....	161
12-8. PRE-HEAT CONTROL	162
12-9. COOL OPERATION.....	162
12-10. DRY OPERATION	163
12-11. HEAT OPERATION	163

(As for outdoor unit MXZ-8A140VA, refer to service manual OC316.)

MSC MICROPROCESSOR CONTROL

MSC-CA20VB MSC-CB20VB MSC-GA20VB MU-GA20VB MUH-GA20VB MUX-2A28VB MUX-3A63VB
 MSC-CA25VB MSC-CB25VB MSC-GA20VB MU-GA25VB MUH-GA25VB MUX-2A59VB MUX-2A70VB
 MSC-CA35VB MSC-CB35VB MSC-GA35VB MU-GA35VB MUH-GA35VB MUX-3A60VB MUX-4A73VB

Once the operation mode is set, the same operation mode can be repeated by simply turning OPERATE/STOP (ON/OFF) button ON. Indoor unit receives the signal with a beep tone.
 When the system turns off, 3-minute time delay will operate to protect system from overload and compressor will not restart for 3 minutes.

WIRELESS REMOTE CONTROLLER

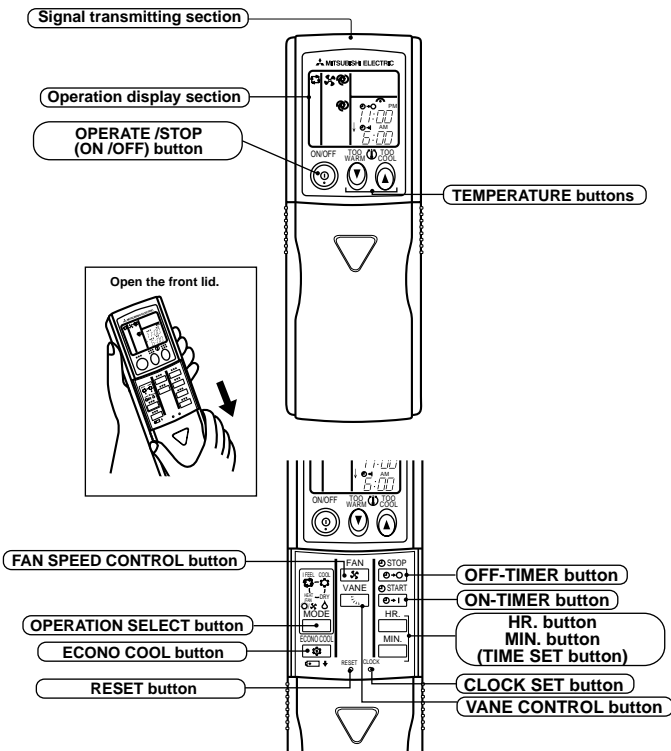

INDOOR UNIT DISPLAY SECTION

Operation Indicator lamp

The operation indicator at the right side of the indoor unit indicates the operation state.

- The following indication does not depend on the shape of lamp.

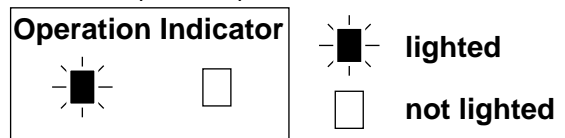

Indication	Operation state	Difference between target temperature and room temperature
	This shows that the air conditioner is operating to reach the target temperature. Please wait until the target temperature is obtained.	Approx. 2 °C or more
	This shows that the room temperature is approaching the target temperature.	Approx. 2 °C or less

1-1. COOL (❄️) OPERATION

- Press OPERATE/STOP(ON/OFF) button. OPERATION INDICATOR lamp of the indoor unit turns on with a beep tone.
- Select COOL mode with OPERATION SELECT button.
- Press TEMPERATURE buttons (TOO WARM or TOO COOL button) to select the desired temperature.
The setting range is 16 ~ 31°C

1. Thermostat control

Thermostat is ON or OFF by difference between room temperature and set temperature

Difference between room temperature and set temperature during operation

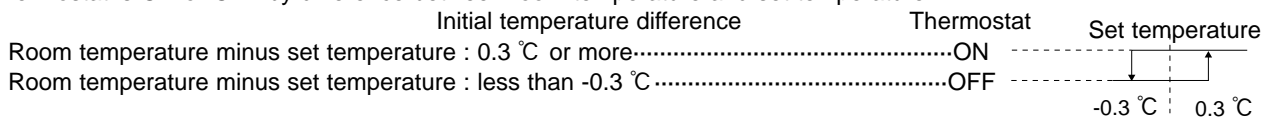

2. Indoor fan speed control

Indoor fan operates continuously at the set speed by FAN SPEED CONTROL button regardless of thermostat's OFF-ON.

In Auto the fan speed is as follows.

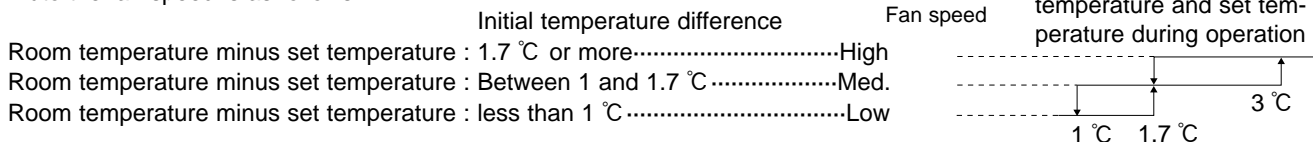

3. Coil frost prevention

① Temperature control

When the indoor coil thermistor RT12 reads 4°C or below(MSC-CA20/CA25/CB20/CB25/GA20/GA25VB) / 0°C or below(MSC-CA35/CB35/GA35VB) for 5 minutes, the coil frost prevention mode starts.

The indoor fan operates at the set speed and the compressor stops for 5 minutes.

After that, if RT12 still reads below 4°C (MSC-CA20/CA25/CB20/CB25/GA20/GA25VB) / 0°C (MSC-CA35/CB35/GA35VB), this mode is prolonged until RT12 reads over 4°C (MSC-CA20/CA25/CB20/CB25/GA20/GA25VB) / 0°C (MSC-CA35/CB35/GA35VB).

② Time control

When the three conditions as follows have been satisfied for 1 hour and 45 minutes, the compressor stops for 3 minutes.

The indoor fan operates at the set speed.

a. Compressor has been continuously operating.

b. Indoor fan speed is Low or Med.

c. Room temperature is below 26°C.

When compressor stops, the accumulated time is cancelled. When compressor restarts, time counting starts from the beginning.

Time counting also stops temporarily when the indoor fan speed becomes High or the room temperature exceeds 26°C. However, when two of the above conditions (b.and c.) are satisfied again, time accumulation is resumed.

Operation chart

Example

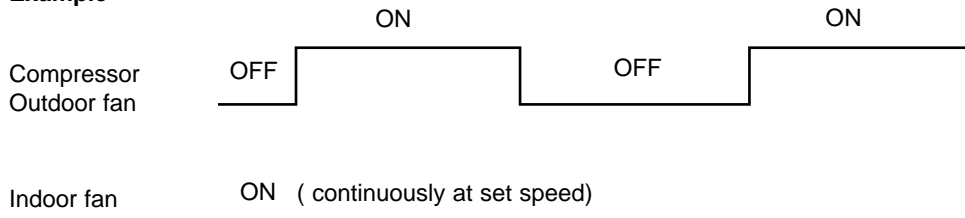

1-2. DRY (Δ) OPERATION

(1) Press OPERATE/STOP(ON/OFF) button.

OPERATION INDICATOR lamp of the indoor unit turns on with a beep tone.

(2) Select DRY mode with the OPERATION SELECT button.

(3) The microprocessor reads the room temperature and determines the set temperature. Set temperature is as shown on the right chart.

DRY operation will not function when the room temperature is 13°C or below.

(4) When DRY operation functions the fan speed is lower than COOL operation except at (fan speed) Low.

The system for dry operation uses the same refrigerant circuit as the cooling circuit.

The compressor and the indoor fan are controlled by the room temperature.

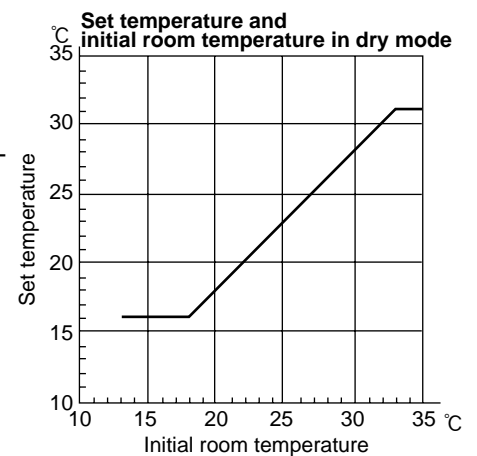

1. Thermostat control

Thermostat is ON or OFF by difference between room temperature and set temperature.

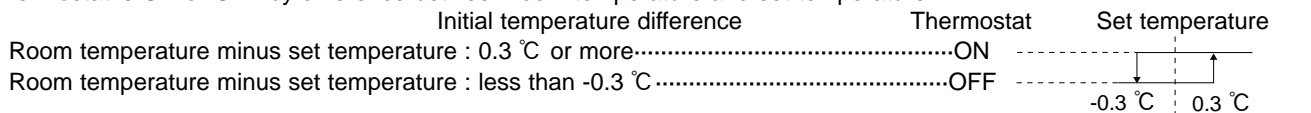

2. Indoor fan speed control

Indoor fan operates at the set speed by FAN SPEED CONTROL button.

In Auto fan speed becomes Low.

3. The operation of the compressor and indoor / outdoor fan

<MU-GA20/GA25/GA35VB, MUH-GA20/GA25/GA35VB, MUX-2A28/2A59/3A60/3A63/2A70/4A73VB>

Compressor operates by room temperature control and time control.

Indoor fan and outdoor fan operate in the same cycle as the compressor.

• When the room temperature is 23°C or over:

When the thermostat is ON, the compressor repeats 8 minutes ON and 3 minutes OFF.

When the thermostat is OFF, the compressor repeats 4 minutes OFF and 1 minute ON.

• When the room temperature is under 23°C.

When the thermostat is ON, the compressor repeats 2 minutes ON and 3 minutes OFF.

When the thermostat is OFF, the compressor repeats 4 minutes OFF and 1 minute ON.

Operation time chart
Example

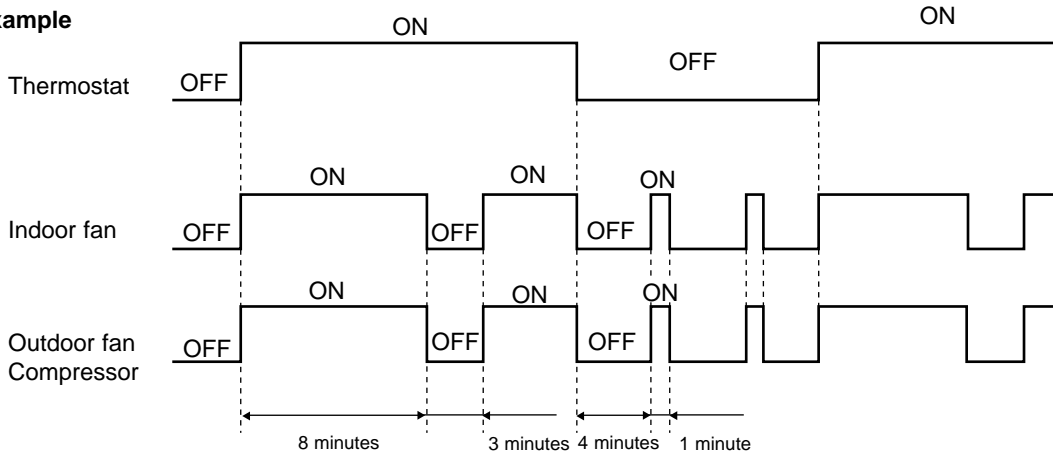

4. Coil frost prevention

The operation is as same as coil frost prevention during COOL operation.(Refer to 1-1.3.)
 However when coil frost prevention works while the indoor fan is OFF, its speed becomes set speed.

1-3. FAN () OPERATION <MU-GA20/GA25/GA35VB, MUX-2A28/2A59/3A60/3A63/2A70/4A73VB>

- (1) Press OPERATE/STOP(ON/OFF) button. OPERATION INDICATOR lamp of the indoor unit turns on with a beep tone.
- (2) Select FAN mode with OPERATION SELECT button.
- (3) Select the desired fan speed. When AUTO, it becomes Low.
 Only indoor fan operates.
 Outdoor unit does not operate.

1-4. HEAT () OPERATION <MUH-GA20/GA25/GA35VB>

- (1) Press OPERATE/STOP(ON/OFF) button.
 OPERATION INDICATOR lamp of the indoor unit turns on with a beep tone.
- (2) Select HEAT mode with the OPERATION SELECT button.
- (3) Press TEMPERATURE buttons (TOO WARM or TOO COOL button) to select the desired temperature.
 The setting range is 16 ~ 31°C.

1. Thermostat control

Thermostat is ON or OFF by difference between room temperature and set temperature.

Difference between room temperature and set temperature during operation

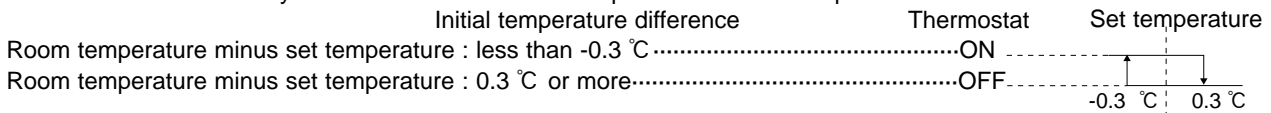

2. Indoor fan speed control

- (1) Indoor fan operates at the set speed by FAN SPEED CONTROL button.
 In Auto the fan speed is as follows.

Difference between room temperature and set temperature during operation

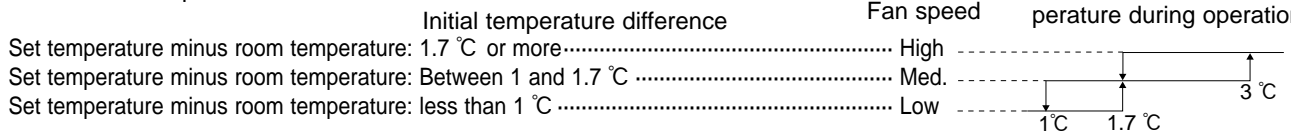

- (2) Cold air prevention control

- ① When the compressor is not operating,
 - (I) if the temperature of indoor coil thermistor RT12 is 0°C or less, the fan stops.
 - (II) if the temperature of indoor coil thermistor RT12 is more than 0°C, the fan operates at Very Low.
- ② When the compressor is operating,
 - (I) if the temperature of RT12 is 22°C or more, the fan operates at set speed.
 - (II) if the temperature of RT12 is less than 22°C and
 - (i) if the temperature of room temperature thermistor RT11 is 15°C or less, the fan stops.
 - (ii) if the temperature of room temperature thermistor RT11 is more than 15°C, the fan operates at Very Low.

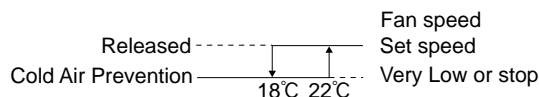

NOTE : If the temperature of RT12 reads from 18°C to 22°C at the air conditioner starting and also after defrosting, this control works.

(3) Warm air control

When the following any conditions of ① (a. ~ c.) and the condition of ② are satisfied at the same time, warm air control works.

- ① a.) When outdoor unit starts operating in HEAT mode.
- b.) When cold air prevention has been released.
- c.) When defrosting has been finished
- ② When the temperature of indoor coil thermistor RT12 is less than 37°C.

When warm air control works, the fan speed changes as follows to blow out warm air gradually.

Gradation of fan speed in initial

<Time condition>	<Indoor fan speed>
less than 2 minutes-----	Low
2 minutes to 4 minutes-----	Med.
more than 4 minutes-----	High

The upper limit of the fan speed in MANUAL is the set speed.

The upper limit of the fan speed in AUTO is the speed decided by indoor fan speed control.(Refer to 1-4.2.(1).)

When the temperature of RT12 has been 37°C or more, or when the set speed has been changed, this control is released and the fan speed is the set speed.

NOTE: As for high pressure protection, defrosting and R.V. coil control, refer to service manual for outdoor unit.

1-5. "I FEEL CONTROL" (□) OPERATION

- (1) Press OPERATE/STOP(ON/OFF) button.
OPERATION INDICATOR lamp of the indoor unit turns on with a beep tone.
- (2) Select "I FEEL CONTROL"(□) mode with the OPERATION SELECT button.
- (3) The operation mode is determined by the initial room temperature at start-up of the operation, as shown on the right table.

Initial room temperature		Mode
MU & MUX type	MUH type	
25°C or more	25°C or more	COOL mode of "I FEEL CONTROL"
more than 13°C, less than 25°C	23°C or more, less than 25°C	DRY mode of "I FEEL CONTROL"
—————	less than 23°C	HEAT mode of "I FEEL CONTROL"

- Once the mode is fixed, the mode does not change by room temperature afterwards.
- Under the ON-TIMER (⊕ → |) operation, mode is determined as follows.

When the system is stopped on the remote controller and restarted within 2 hours in "I FEEL CONTROL" (□) mode, the system operates in previous mode automatically regardless of the room temperature.

Operation time chart

Example

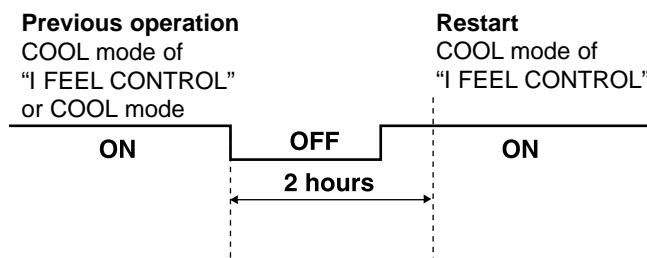

When the system is restarted after 2 hours and more, the operation mode is determined by the room temperature at start-up of the operation.

Operation time chart

Example

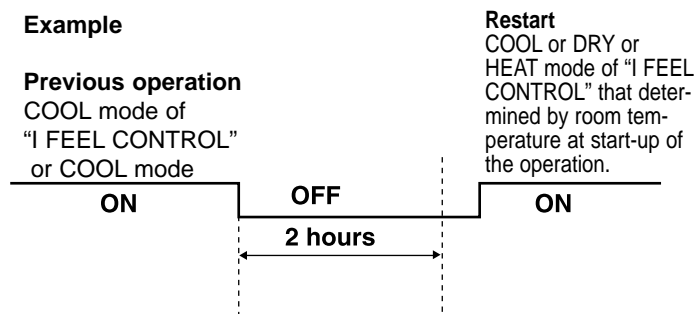

(4) The initial set temperature is decided by the initial room temperature.

Mode	Initial room temperature		Initial set temperature	
	MU & MUX type	MUH type		
COOL mode of "I FEEL CONTROL"	26°C or more	26°C or more	24°C	*1
	25°C or more, less than 26°C	25°C or more, less than 26°C	Initial room temperature minus 2°C	
DRY mode of "I FEEL CONTROL"	more than 13°C, less than 25°C	23°C or more, less than 25°C	Initial room temperature minus 2°C	
HEAT mode of "I FEEL CONTROL"	————	less than 23°C	26°C	

*1 When the system is restarted with the remote controller, the system operates with the previous set temperature regardless of the room temperature at restart.

(5) TEMPERATURES buttons

In "I FEEL CONTROL" (□) mode, set temperature is decided by the microprocessor based on the room temperature. In addition, set temperature can be controlled by TOO WARM or TOO COOL buttons when you feel too cool or too warm. Each time the TOO WARM or TOO COOL button is pressed, the indoor unit receives the signal and emits a beep tone.

• Fuzzy control

When the TOO COOL or TOO WARM button is pressed, the microprocessor changes the set temperature, considering the room temperature, the frequency of pressing TOO COOL or TOO WARM button and the user's preference to heat or cool. So this is called "Fuzzy control", and works only in "I FEEL CONTROL" mode. In DRY mode of "I FEEL CONTROL", the set temperature doesn't change.



... To raise the set temperature 1~2 degrees(°C)



... To lower the set temperature 1~2 degrees(°C)

1-5-1. COOL mode of "I FEEL CONTROL"

1. Thermostat control

Thermostat control is as same as COOL OPERATION.(1-1.1.)

2. Indoor fan speed control

Indoor fan speed control is as same as COOL OPERATION.(1-1.2.)

3. Coil frost prevention

Coil frost prevention is as same as COOL OPERATION.(1-1.3.)

1-5-2. DRY mode of "I FEEL CONTROL"

1. Thermostat control

Thermostat control is as same as DRY OPERATION.(1-2.1.)

2. Indoor fan speed control

Indoor fan speed control is as same as DRY OPERATION.(1-2.2.)

3. The operation of the compressor and indoor/outdoor fan

The operation of the compressor and indoor/outdoor fan is as same as DRY OPERATION.(1-2.3.)

4. Coil frost prevention

Coil frost prevention is as same as DRY OPERATION.(1-2.4.)

1-5-3. HEAT mode of "I FEEL CONTROL" <MUH-GA20/GA25/GA35VB>

1. Thermostat control

Thermostat control is as same as HEAT OPERATION.(1-4.1.)

2. Indoor fan speed control

Indoor fan speed control is as same as HEAT OPERATION.(1-4.2.)

NOTE: As for high pressure protection, defrosting and R.V. coil control, refer to service manual for outdoor unit.

1-6. INDOOR FAN MOTOR CONTROL

(1) Rotational frequency feedback control

The indoor fan motor is equipped with a rotational frequency sensor, and outputs signal to the microprocessor to feedback the rotational frequency. Comparing the current rotational frequency with the target rotational frequency (High, Med., Low), the microprocessor controls SR141 and adjusts fan motor electric current to make the current rotational frequency close to the target rotational frequency. With this control, when the fan speed is switched, the rotational frequency changes smoothly.

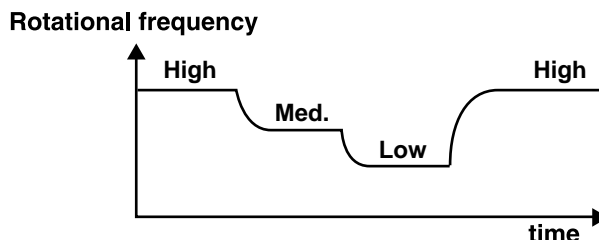

(2) Fan motor lock-up protection

When the rotational frequency feedback signal is not output for 12 seconds, (or when the microprocessor cannot detect the signal for 12 seconds) the fan motor is regarded locked-up. Then the electric current to the fan motor is shut off. 3 minutes later, the electric current is applied to the fan motor again. During the fan motor lock-up, the OPERATION INDICATOR lamp flashes on and off to show the fan motor abnormality.

1-7. AUTO VANE OPERATION

(1) Vane motor drive

These models are equipped with a stepping motor for the horizontal vane. The rotating direction, speed, and angle of the motor are controlled by pulse signals (approx. 12V) transmitted from indoor microprocessor.

(2) The horizontal vane angle and mode change as follows by pressing the VANE CONTROL button.

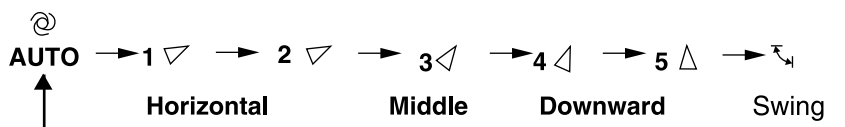

(3) Positioning

The vane presses the vane stopper once to confirm the standard position and then set to the desired angle. Confirming of standard position is performed in case of follows.

- (a) When the OPERATE/STOP(ON/OFF) button is pressed.
- (b) When the vane control is changed from AUTO to MANUAL.
- (c) When the SWING is finished.
- (d) When the test run starts.
- (e) When the power supply turns ON.

(4) VANE AUTO (@) mode

The microprocessor automatically determines the vane angle to make the optimum room temperature distribution.

COOL and DRY operation
Vane angle is fixed to Angle 1.

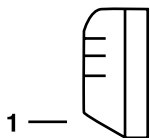

FAN operation
<MU-GA20/GA25/GA35VB, MUX-A28/2A59/3A60/3A63/2A70/4A73VB>

HEAT operation
<MUH-GA20/GA25/GA35VB>

Vane angle is fixed to Angle 4.

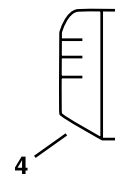

(5) Dew prevention

During COOL or DRY operation at Vane Angle 4 or 5 when the cumulative operation time of compressor exceeds 1 hour, the vane angle automatically changes to Angle 1 for dew prevention.

(6) SWING MODE (⚡)

By selecting SWING mode with the VANE CONTROL button, the horizontal vane swings vertically. The remote controller displays " ⚡ ".

(7) Cold air prevention in HEAT operation <MUH-GA20/GA25/GA35VB>

When any of the following conditions occurs in HEAT operation, the horizontal vane angle changes to Angle 1 automatically to prevent cold air blowing on users.

- ① Compressor is not operating.
- ② Defrosting is performed.
- ③ Indoor coil thermistor RT12 reads 24°C or below.
- ④ Indoor coil thermistor RT12 temperature is raising from 24°C or below, but it does not exceed 28°C.

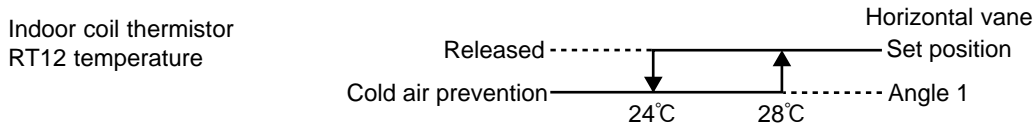

NOTE : If the temperature of RT12 reads from 24°C to 28°C at the air conditioner stating , this control works.

(8) ECONO COOL () operation (ECONOMical operation)

When the ECONO COOL button is pressed in COOL mode, set temperature is automatically set 2°C higher.

Also the horizontal vane swings in various cycle according to the temperature of indoor heat exchanger(RT12).

SWING operation makes you feel cooler than set temperature. So, even though the set temperature is higher, the air conditioner can keep comfort. As a result, energy can be saved.

ECONO COOL operation is cancelled when the ECONO COOL button is pressed once again or VANE CONTROL button is pressed or operation mode is changed.

NOTE : ECONO COOL operation does not work in COOL mode of “I FEEL CONTROL”.

<SWING operation>

In swing operation of ECONO COOL operation mode, the initial air flow direction is adjusted to “Horizontal”.

According to the temperature of indoor coil thermistor RT12 at starting of this operation, next downward blow time is decided. Then when the downward blow has been finished, next upward blow time is decided.

For initial 10 min. the swing operation is performed in table G~H for quick cooling.

Also, after 10 min. when the difference of set temperature and room temperature is more than 2 degrees, the swing operation is performed in table D~H for more cooling.

The air conditioner repeats the swing operation in various cycle as follows.

	Temperature of indoor coil thermistor RT12	Downward blow time (sec.)	Horizontal blow time (sec.)
A	15°C or less	2	23
B	15°C to 17°C	5	20
C	17°C to 18°C	8	17
D	18°C to 20°C	11	14
E	20°C to 21°C	14	11
F	21°C to 22°C	17	8
G	22°C to 24°C	20	5
H	more than 24°C	23	2

1-8. TIMER OPERATION

1. How to set the timer

(1) Press OPERATE/STOP(ON/OFF) button to start the air conditioner.

(2) Check that the current time is set correctly.

NOTE : Timer operation will not work without setting the current time. Initially “AM0:00” blinks at the current time display of TIME MONITOR, so set the current time correctly with CLOCK SET button.

(3) Press ON or OFF TIMER buttons to select the operation.

“⊕→|” button... AUTO START operation (ON timer)

“⊕→○” button... AUTO STOP operation (OFF timer)

(4) Press HR. and MIN. button to set the timer. Time setting is 10-minute units.

HR. and MIN. button will work when “ ⊕→| ” or “ ⊕→○ ” mark is flashing.
These marks disappear in 1 minute.

After setting ON timer, check that OPERATION INDICATOR lamp of the indoor unit lights.

NOTE1 : Be sure to place the remote controller at the position where its signal can reach the air conditioner even during TIMER operation, or the set time may deviate within the range of about 10 minutes.

NOTE2 : Reset the timer in the following cases, or the set time may deviate and other malfunctions may occur.

- A power failure occurs.
- The circuit breaker functions.

2. Cancel

TIMER setting can be cancelled with ON or OFF TIMER buttons. (“ ⊕→| ” or “ ⊕→○ ”)

To cancel ON timer, press “ ⊕→| ” button.

To cancel OFF timer, press “ ⊕→○ ” button.

TIMER is cancelled and the display of set time disappears.

PROGRAM TIMER

- OFF timer and ON timer can be used in combination.
- “ ↑ ” and “ ↓ ” display shows the order of OFF timer and ON timer operation.

(Example 1) The current time is 8:00 PM.

The unit turns off at 11:00 PM, and on at 6:00 AM.

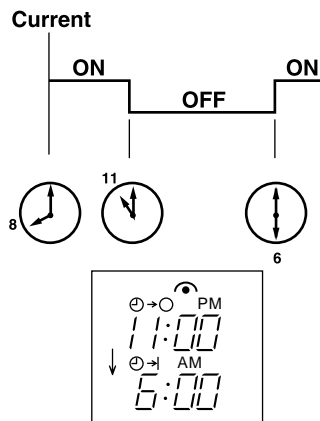

(Example 2) The current time is 11:00 AM.

The unit turns on at 5:00 PM, and off at 9:00 PM.

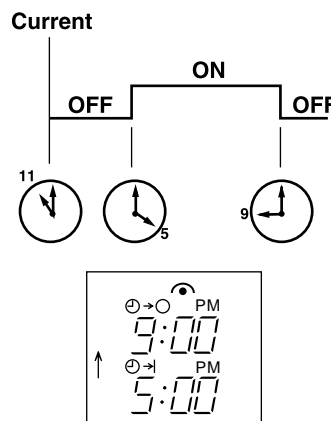

NOTE : TIMER setting will be cancelled by power failure or breaker functioning.

1-9. EMERGENCY / TEST OPERATION

In case of test run operation or emergency operation, use EMERGENCY OPERATION switch on the front of the indoor unit. Emergency operation is available when the remote controller is missing, has failed or the batteries of remote controller run down. The unit will start and OPERATION INDICATOR lamp will light.

The first 30 minutes of operation is the test run operation. This operation is for servicing. The indoor fan speed runs at High speed and the system is in continuous operation. (The thermostat is ON.)

After 30 minutes of test run operation, the system shifts to EMERGENCY COOL [/ HEAT<MUH-GA20/GA25/GA35VB>] MODE with a set temperature of 24°C. The fan speed shifts to Med. speed.

The coil frost prevention works even in emergency operation [, and defrosting<MUH-GA20/GA25/GA35VB> too].

In the test run or emergency operation, the horizontal vane operates in VANE AUTO (@) mode.

Emergency operation continues until EMERGENCY OPERATION switch is pressed once again (MU-GA20/GA25/GA35VB, MUX-2A28/2A59/3A60/3A63/2A70/4A73VB)/once or twice (MUH-GA20/GA25/GA35VB) or the unit receives any signal from the remote controller.

In case of latter, normal operation will start.

NOTE : Do not press EMERGENCY OPERATION switch during normal operation.

- The following indication does not depend on the shape of lamp.

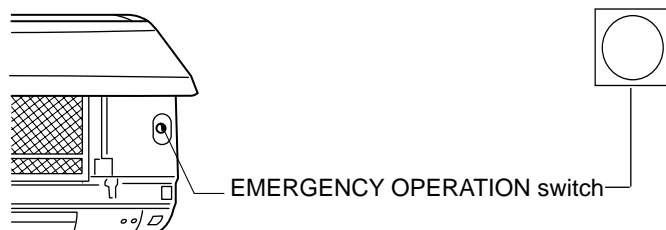

OPERATION INDICATOR lamp

- | | | | | |
|-------------------------|--------------------------|--------------------------|--------------------------|-------------|
| Press once <Cool> | | <input type="checkbox"/> | | Lighted |
| Press again <Heat> | <input type="checkbox"/> | | <input type="checkbox"/> | Not lighted |
| Press once again <Stop> | <input type="checkbox"/> | <input type="checkbox"/> | | |

* Heat is available only in MUH-GA20/GA25/GA35VB.

1-10. OUTDOOR UNIT ACTUATOR CONTROL

MUX-2A28VB

ACTUATOR		INDOOR UNIT	A	B
COMPRESSOR	MC	ON	ON	ON
		OFF	OFF	ON
		OFF	OFF	OFF
OUTDOOR FAN MOTOR	MF	ON	ANY UNIT ON	
		OFF	OFF	OFF
SOLENOID VALVE	21R (BALANCE)	ON (CLOSE)	ON	ON
		OFF (OPEN)	OFF	ON
		OFF (CLOSE)	OFF	OFF
	21R1	ON (OPEN)	ON	-
		OFF (CLOSE)	OFF	-
	21R2	ON (OPEN)	-	ON
OFF (CLOSE)		-	OFF	

MUX-2A59VB MUX-2A70VB

ACTUATOR		INDOOR UNIT	A	B
COMPRESSOR	MC1	ON	ON	-
		OFF	OFF	-
	MC2	ON	-	ON
		OFF	-	OFF
OUTDOOR FAN MOTOR	MF61	ON	ANY UNIT ON	
		OFF	OFF	OFF

MUX-4A73VB

ACTUATOR		INDOOR UNIT	A	B	C	D
COMPRESSOR	MC1	ON	ON	ON	-	-
		OFF	OFF	OFF	-	-
		OFF	OFF	OFF	-	-
	MC2	ON	-	-	ON	ON
		OFF	-	-	OFF	ON
		OFF	-	-	OFF	OFF
OUTDOOR FAN MOTOR	MF61	ON	ANY UNIT ON			
		OFF	OFF	OFF	OFF	OFF
SOLENOID VALVE	21R1	ON (OPEN)	ON	-	-	-
		OFF (CLOSE)	OFF	-	-	-
	21R2	ON (OPEN)	-	ON	-	-
		OFF (CLOSE)	-	OFF	-	-
	21R3	ON (OPEN)	-	-	ON	-
		OFF (CLOSE)	-	-	OFF	-
	21R4	ON (OPEN)	-	-	-	ON
		OFF (CLOSE)	-	-	-	OFF
	21RA (BALANCE)	ON (CLOSE)	ON	ON	-	-
		OFF (OPEN)	OFF	OFF	-	-
	21RB (BALANCE)	ON (CLOSE)	-	-	ON	ON
		OFF (OPEN)	-	-	OFF	OFF

MUX-3A60VB MUX-3A63VB

ACTUATOR		INDOOR UNIT	A	B	C
COMPRESSOR	MC1	ON	ON	-	-
		OFF	OFF	-	-
	MC2	ON	-	ON	ON
		OFF	-	OFF	OFF
OUTDOOR FAN MOTOR	MF61	ON	ANY UNIT ON		
		OFF	OFF	OFF	OFF
SOLENOID VALVE	21R3	ON (OPEN)	-	ON	-
		OFF (CLOSE)	-	OFF	-
	21R4	ON (OPEN)	-	-	ON
		OFF (CLOSE)	-	-	OFF
	21RB	ON (CLOSE)	-	ON	ON
		OFF (OPEN)	-	OFF	OFF

"-" means that the indoor unit is not related to the control of actuator.

MS-GA50VB MU-GA50VB
 MS-GA60VB MU-GA60VB
 MS-GA80VB MU-GA80VB

WIRELESS REMOTE CONTROLLER

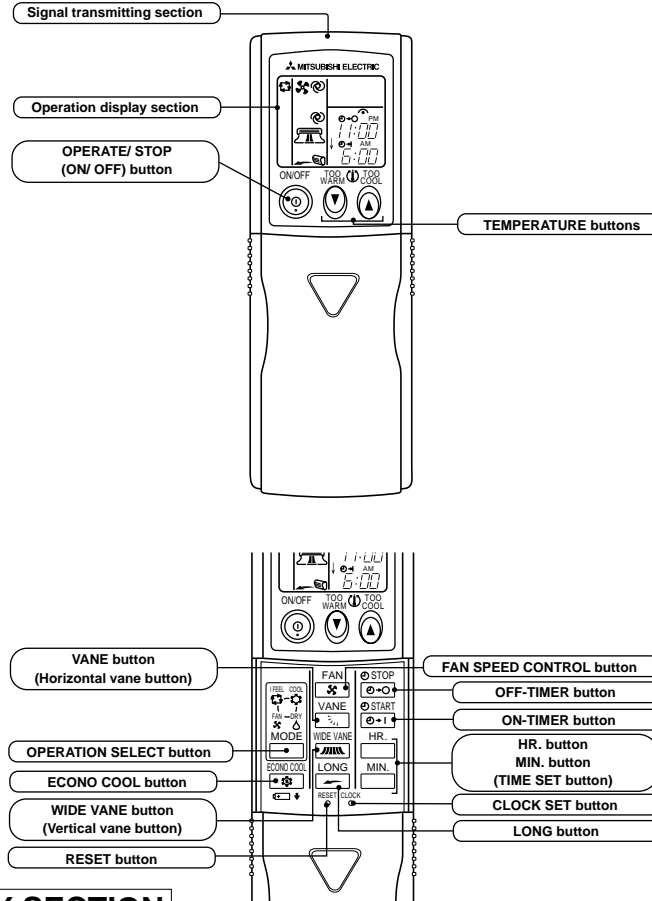

INDOOR UNIT DISPLAY SECTION

Operation Indicator lamp

The operation indicator at the right side of the indoor unit indicates the operation state.

- The following indication applies regardless of shape of the indicator.

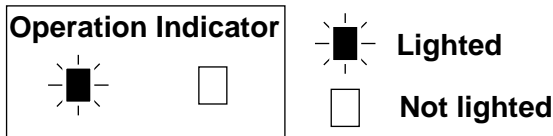

Indication	Operation state	Difference between target temperature and room temperature
	This shows that the air conditioner is operating to reach the target temperature. Please wait until the target temperature is obtained.	Approx. 2 °C or more
	This shows that the room temperature is approaching the target temperature.	Approx. 2 °C or less

Once the operation mode is set, the same operation mode can be repeated by simply turning OPERATE/STOP (ON/OFF) button ON.

Indoor unit receives the signal with a beep tone.

When the system turns off, 3-minute time delay will operate to protect system from overload and compressor will not restart for 3 minutes.

2-1. "I FEEL CONTROL" (☐) OPERATION

- (1) Press OPERATE/STOP (ON/OFF) button on the remote controller. OPERATION INDICATOR lamp of the indoor unit turns on with a beep tone.
- (2) Select "I FEEL CONTROL" mode with OPERATION SELECT button.
- (3) The operation mode is determined by the room temperature at start-up of the operation.

Initial room temperature	Mode
25°C or more	COOL mode of "I FEEL CONTROL"
more than 13°C, less than 25°C	DRY mode of "I FEEL CONTROL"

- Once the mode is fixed, the mode does not change by room temperature afterwards.
- Under the ON-TIMER (⊕ → |) operation, mode is determined as follows.

When the system is stopped on the remote controller, and restarted within 2 hours in "I FEEL CONTROL" (□) mode, the system operates in previous mode automatically regardless of the room temperature.

Operation timer chart

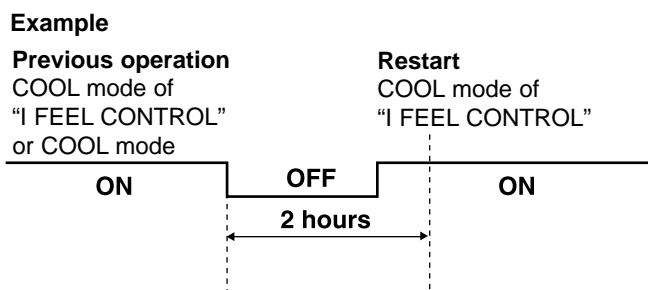

When the system is restarted after 2 hours and more, the operation mode is determined by the room temperature at start-up of the operation.

Operation timer chart

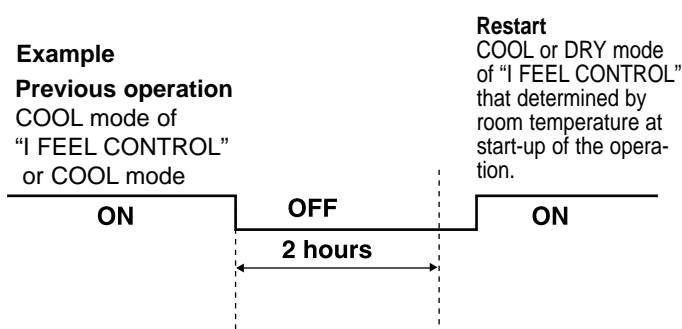

(4) The initial set temperature is decided by the initial room temperature.

Model	Initial room temperature	Initial set temperature	
COOL mode of "I FEEL CONTROL"	26°C or more	24°C	*1
	25°C to 26°C	Initial room temperature minus 2°C	
DRY mode of "I FEEL CONTROL"	more than 13°C, less than 25°C	Initial room temperature minus 2°C	

*1 When the system is restarted with the remote controller, the system operates with the previous set temperature regardless of room temperature at restart.
The set temperature is calculated by the previous set temperature.

(5) TEMPERATURE buttons

In "I FEEL CONTROL" (□) mode, set temperature is decided by the microprocessor based on the room temperature. In addition, set temperature can be controlled by TOO WARM or TOO COOL buttons when you feel too cool or too warm. Each time the TOO WARM or TOO COOL button is pressed, the indoor unit receives the signal and emits a beep tone.

• Fuzzy control

When the TOO COOL or TOO WARM button is pressed, the microprocessor changes the set temperature, considering the room temperature, the frequency of pressing TOO COOL or TOO WARM button and the user's preference to heat or cool. So this is called "Fuzzy control", and works only in "I FEEL CONTROL" mode.
In DRY mode of "I FEEL CONTROL", the set temperature doesn't change.

 ...To raise the set temperature 1~2°C

 ...To lower the set temperature 1~2°C

2-1-1. COOL mode of "I FEEL CONTROL"

1. Indoor fan speed control

Indoor fan operates at the set speed by FAN SPEED CONTROL button.
 In AUTO the fan speed is as follows.

Initial temperature difference	Fan Speed	Difference between room temperature and set temperature during operation
Room temperature minus set temperature : 1.7 °C or more	High	
Room temperature minus set temperature : Between 1 and 1.7 °C	Med.	
Room temperature minus set temperature : less than 1 °C	Low	

2. Coil frost prevention

① Temperature control

When the indoor coil thermistor RT12 reads 3°C or below (MS-GA50VB) / 1°C or below (MS-GA60VB) / RT12 or RT13 reads -1°C or below (MS-GA80VB), the coil frost prevention mode starts immediately.
 However, the coil frost prevention doesn't work for 5 minutes since the compressor has started.
 The indoor fan operates at the set speed and the compressor stops for 5 minutes.
 After that, if RT12 still reads below 3°C (MS-GA50VB) / 1°C (MS-GA60VB) / RT12 or RT13 still reads below -1°C (MS-GA80VB) this mode prolonged until the RT12 reads over 3°C (MS-GA50VB) / 1°C (MS-GA60VB) / RT12 or RT13 still reads over -1°C (MS-GA80VB).

② Time control

When the three conditions as follows have been satisfied for 1 hour and 45 minutes, compressor stops for 3 minutes.
 a. Compressor has been continuously operating.
 b. Indoor fan speed is Low or Med.
 c. Room temperature is below 26°C.
 When compressor stops, the accumulated time is cancelled and when compressor restarts, time counting starts from the beginning.
 Time counting also stops temporarily when the indoor fan speed becomes High or the room temperature exceeds 26°C. However, when two of the above conditions (b. and c.) are satisfied again. Time accumulation is resumed.

Operation chart

Example

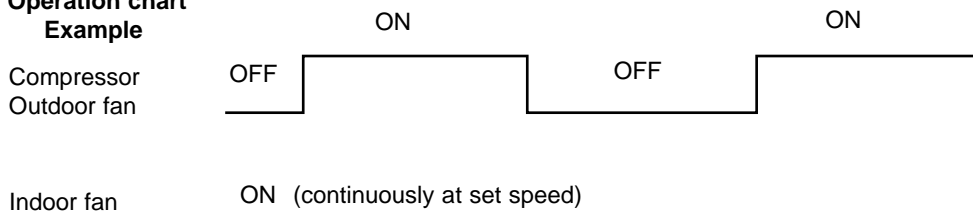

3. Outdoor fan speed control <MU-GA80VB>

Outdoor fan speed is controlled according to the temperature of ambient temperature thermistor RT63.
 Outdoor fan Low operation : When the outside temperature decreases to 20°C or less.
 Until the outside temperature goes to 22°C.
 Outdoor fan High operation : Until the outside temperature decreases to 20°C or less.
 When the outside temperature goes to 22°C.

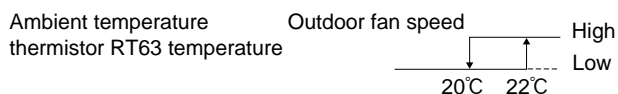

NOTE : When indoor fan speed is Low except FAN operation mode and the outside temperature is 30°C or less, the outdoor fan operates at Low.

Outdoor fan Low operation is cancelled according to the following conditions(① or ②):

- ① When the operation is not changed and the outside temperature goes to 33°C or more.
- ② When the operation is changed. (Change to FAN operation mode / Change of the indoor fan speed)

4. Discharge temperature protection <MU-GA80VB>

The compressor is controlled by the temperature of discharge temperature thermistor RT62 for excess rise protection of compressor discharge pressure.

• Compressor

When the temperature of discharge temperature thermistor RT62 goes to 120°C or more, the compressor is turned OFF.
 After 3 minutes since the compressor has been turned OFF, if the temperature of discharge temperature thermistor RT62 becomes 100°C or less, the compressor is turned ON.

2-1-2. DRY mode of "I FEEL CONTROL"

The system for dry operation uses the same refrigerant circuit as the cooling circuit.

The compressor and the indoor fan are controlled by the room temperature.

By such controls, indoor flow amounts will be reduced in order to lower humidity without much room temperature decrease.

1. Indoor fan speed control

Indoor fan operates at the set speed by FAN SPEED CONTROL button.

However, in AUTO fan operation, fan speed becomes Low.

2. The operation of the compressor and indoor/ outdoor fan

Compressor operates by room temperature control and time control.

Set temperature is controlled to fall 2°C from initial room temperature.

Indoor fan and outdoor fan operate in the same cycle as the compressor.

•When the room temperature is 23°C or over:

When the thermostat is ON, the compressor repeats 8 minutes ON and 3 minutes OFF.

When the thermostat is OFF, the compressor repeats 4 minutes OFF and 1 minute ON.

•When the room temperature is under 23°C.

When the thermostat is ON, the compressor repeats 2 minutes ON and 3 minutes OFF.

When the thermostat is OFF, the compressor repeats 4 minutes OFF and 1 minute ON.

Operation time chart

Example

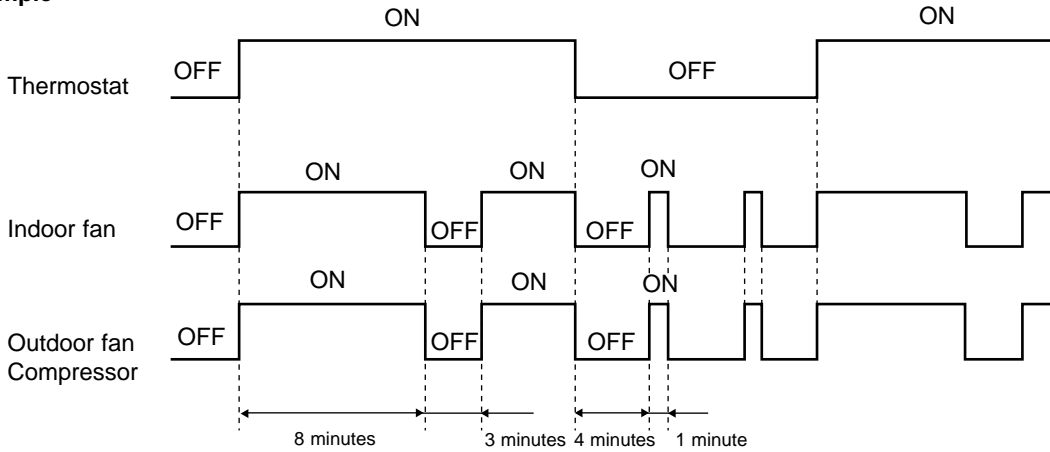

3. Coil frost prevention

• The operation is as same as coil frost prevention during COOL mode of "I FEEL CONTROL".

• Indoor fan operates at the set speed and the compressor stops for 5 minutes, because protection(Coil frost prevention) has the priority.

However, when coil frost prevention works while the compressor is not operating, its speed becomes Low.

4. Outdoor fan speed control <MU-GA80VB>

Outdoor fan speed control is as same as one of COOL mode of "I FEEL CONTROL".

2-2. COOL () OPERATION

(1) Press OPERATE/STOP (ON/OFF) button.

OPERATION INDICATOR lamp of the indoor unit turns on with a beep tone.

(2) Select COOL mode with OPERATION SELECT button.

(3) Press TEMPERATURE buttons.

(TOO WARM or TOO COOL button) to select the desired temperature.

The setting range is 16 ~ 31°C.

* Indoor fan continues to operate regardless of thermostat's OFF-ON at set speed.

* Coil frost prevention is as same as COOL mode of "I FEEL CONTROL".

2-3. DRY (△) OPERATION

- (1) Press OPERATE/STOP (ON/OFF) button. OPERATION INDICATOR lamp of the indoor unit turns on with a beep tone.
- (2) Select DRY mode with OPERATION SELECT button.
- (3) The microprocessor reads the room temperature and determines the set temperature. Set temperature is as shown on the right chart. Thermostat (SET TEMP.) does not work. The other operations are same as DRY mode of "I FEEL CONTROL".
- (4) DRY operation will not function when the room temperature is 13°C or below.

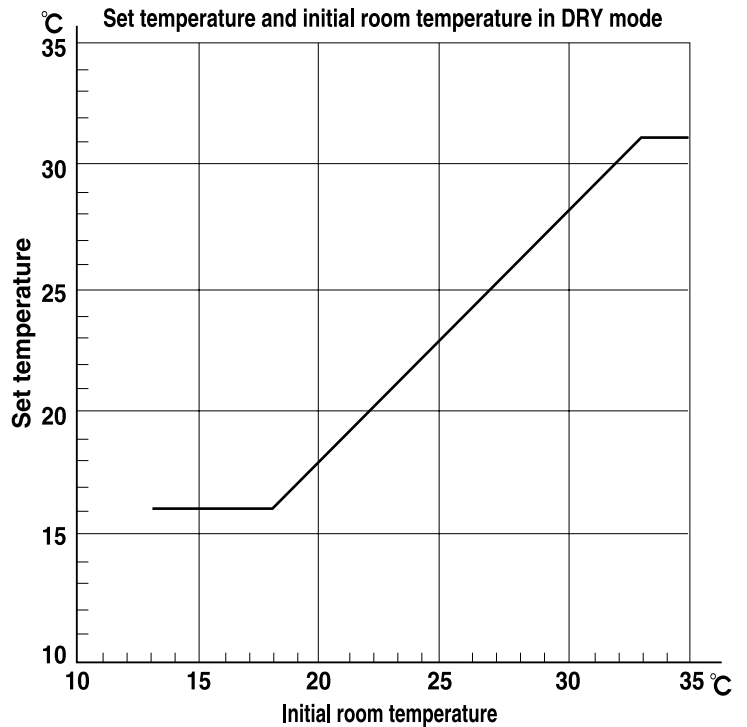

2-4. FAN (✖) OPERATION

- (1) Press OPERATE/STOP (ON/OFF) button. OPERATION INDICATOR lamp of the indoor unit turns ON with a beep tone.
- (2) Select FAN mode with OPERATION SELECT button.
- (3) Select the desired fan speed. When AUTO, it becomes Low. Only indoor fan operates. Outdoor unit does not operate.

2-5. INDOOR FAN MOTOR CONTROL

- (1) Rotational frequency feedback control
The indoor fan motor is equipped with a rotational frequency sensor, and outputs signal to the microprocessor to feedback the rotational frequency. Comparing the current rotational frequency with the target rotational frequency (High, Med., Low), the microprocessor controls SR141 and adjusts fan motor electric current to make the current rotational frequency close to the target rotational frequency. With this control, when the fan speed is switched, the rotational frequency changes smoothly.

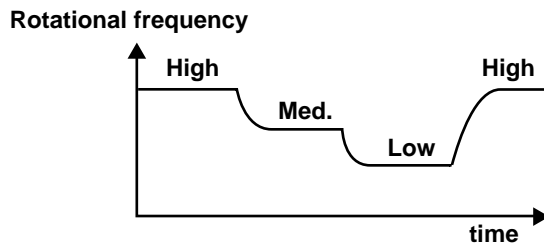

- (2) Fan motor lock-up protection
When the rotational frequency feedback signal has not output for 12 seconds, (or when the microprocessor cannot detect the signal for 12 seconds) the fan motor is regarded locked-up. Then the electric current to the fan motor is shut off. 3 minutes later, the electric current is applied to the fan motor again. During the fan motor lock-up, the OPERATION INDICATOR Indicator lamp flashes on and off to show the fan motor abnormality.

2-6. AUTO VANE OPERATION

1. Horizontal vane

- (1) Vane motor drive
These models are equipped with a stepping motor for the horizontal vane. The rotating direction, speed, and angle of the motor are controlled by pulse signals (approx. 12V) transmitted from indoor microprocessor.
- (2) The horizontal vane angle and mode change as follows by pressing the VANE button.

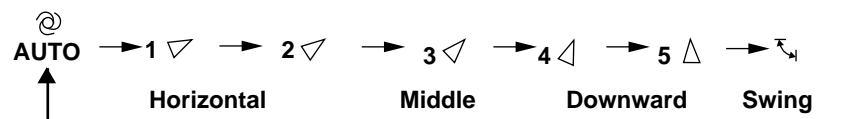

(3) Positioning

The vane presses the vane stopper once to confirm the standard position and then moves to the set angle. Confirming of standard position is performed in case of follows.

- (a) When the power supply turns ON.
- (b) When the operation starts or finishes (including timer operation).
- (c) When the test run starts.
- (d) When the vane control is changed AUTO to MANUAL (except SWING).
- (e) When the SWING is finished (including ECONO COOL).

(4) VANE AUTO () mode

The microprocessor automatically determines the horizontal vane angle and operation to make the optimum room temperature distribution.

COOL and DRY operation

Vane angle is fixed to Angle 1.

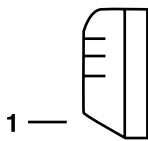

FAN operation

Vane angle is fixed to Angle 4.

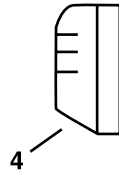

(5) STOP (operation OFF) and ON-TIMER standby

When the following cases occur, the horizontal vane returns to the closed position.

- (a) When OPERATE/STOP (ON/OFF) button is pressed (POWER OFF).
- (b) When the operation is stopped by the emergency operation.
- (c) When ON-TIMER is on standby.

(6) Dew prevention

During COOL or DRY operation at Vane Angle 4 or 5 when the compressor cumulative operation time of compressor exceeds 1 hour, the vane angle automatically changes to Angle 1 for dew prevention.

(7) SWING MODE ()

By selecting SWING mode with VANE button, the horizontal vane swings vertically. The remote controller displays “  ”. SWING mode is cancelled when VANE button is pressed once again.

(8) ECONO COOL () operation (ECONOMical operation)

When ECONO COOL button is pressed in COOL mode, set temperature is automatically set 2°C higher.

Also the horizontal vane swings in various cycle according to the temperature of indoor heat exchanger(Tp(* 1)).

SWING operation makes you feel cooler than set temperature. So, even though the set temperature is higher, the air conditioner can keep comfort. As a result, energy can be saved.

ECONO COOL operation is cancelled when ECONO COOL button is pressed once again or VANE button is pressed or LONG button is pressed or change to other operation mode.

NOTE : ECONO COOL operation does not work in COOL mode of “I FEEL CONTROL”.

<SWING operation>

* 1 Tp : • Value of RT12 (MS-GA50/GA60VB)

• Minimum value of indoor coil thermistor (main) RT12 and indoor coil thermistor (sub) RT13 (MS-GA80VB)

In swing operation of ECONO COOL operation mode, the initial air flow direction is adjusted to “Horizontal”.

According to the temperature of indoor coil thermistor Tp(* 1) at starting of this operation, next downward blow time is decided. Then when the downward blow has been finished, next horizontal blow time is decided.

For initial 10 minutes the swing operation is performed in table G~H for quick cooling.

Also, after 10 minutes when the difference of set temperature and room temperature is more than 2°C, the swing operation is performed in table D~H for more cooling.

The air conditioner repeats the swing operation in various cycle as follows.

	Temperature of Tp(* 1)	Downward blow time (second)	Horizontal blow time (second)
A	15°C or less	2	23
B	15°C to 17°C	5	20
C	17°C to 18°C	8	17
D	18°C to 20°C	11	14
E	20°C to 21°C	14	11
F	21°C to 22°C	17	8
G	22°C to 24°C	20	5
H	more than 24°C	23	2

(9) LONG MODE ()

By pressing LONG button indoor fan speed becomes faster than setting fan speed on the remote controller, and the horizontal vane moves to the position for LONG mode. The remote controller displays “  ”. LONG mode is cancelled when LONG button is pressed once again or VANE button is pressed or ECONO COOL button is pressed in COOL mode.

• In the following example, the vertical vane is set to  (front.).

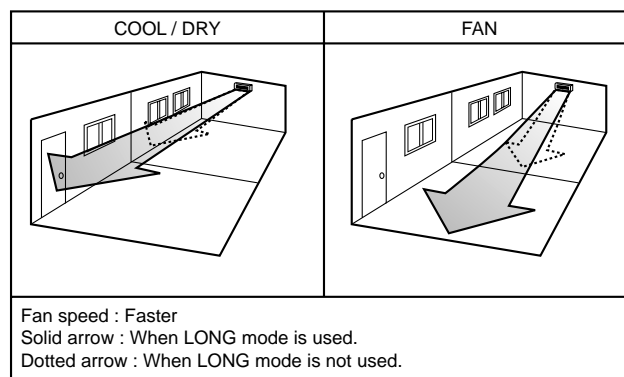

2. Vertical vane

(1) Vane motor drive

These models are equipped with a stepping motor for the vertical vane. The rotating direction, speed, and angle of the motor are controlled by pulse signals (approx. 12V) transmitted from microprocessor.

(2) The vertical vane angle and mode change as follows by pressing WIDE VANE button.

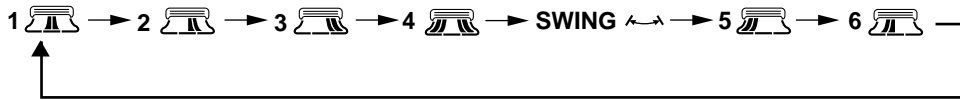

(3) Positioning

The vane is once pressed to the vane stopper to confirm the standard position and then set to the desired angle. Confirming of standard position is performed in case of follows.

- When OPERATE/STOP(ON/OFF) button is pressed (POWER ON/OFF).
- When SWING is started or finished.
- When the power supply turns ON.

(4) SWING MODE (↔)

By selecting SWING mode with WIDE VANE button, the vertical vane swings horizontally. The remote controller displays "↔". The vane moves right and left in the width of Angle 4 repeatedly.

(5) WIDE MODE (🌀)

By selecting WIDE mode with WIDE VANE button, indoor fan speed becomes faster than setting fan speed on the remote controller (*). The remote controller displays "🌀".

- * Indoor fan speed becomes faster than setting fan speed on the remote controller even when 🌀 or 🌀 is selected.

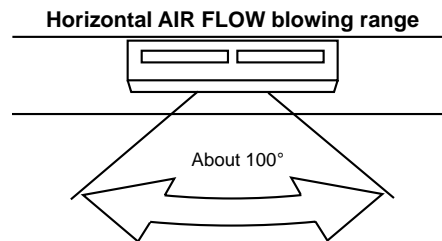

2-7. TIMER OPERATION

1. How to set the timer

- Press OPERATE/STOP (ON/OFF) button to start the air conditioner.
- Check that the current time is set correctly.

NOTE : Timer operation will not work without setting the current time. Initially "AM0:00" blinks at the current time display of TIME MONITOR, so set the current time correctly with CLOCK SET button.

(3) Press ON/OFF TIMER buttons to select the operation.

- "ON-TIMER" button... AUTO START operation (ON timer)
- "OFF-TIMER" button... AUTO STOP operation (OFF timer)

(4) Press HR. and MIN. button to set the timer. Time setting is 10-minute units.

HR. and MIN. button will work when "⊖→|" or "⊖→○" mark is flashing. These marks disappear in 1 minute.

After setting the ON timer, check that OPERATION INDICATOR lamp of the indoor unit lights.

NOTE1 : Be sure to place the remote controller at the position where its signal can reach the air conditioner even during TIMER operation, or the set time may deviate within the range of about 10 minutes.

NOTE2 : Reset the timer in the following cases, or the set time may deviate and other malfunctions may occur.

- A power failure occurs.
- The circuit breaker functions.

2. Cancel

TIMER setting can be cancelled with ON/OFF TIMER buttons.

To cancel ON timer, press "ON-TIMER" button.

To cancel OFF timer, press "OFF-TIMER" button.

TIMER is cancelled and the display of set time disappears.

PROGRAM TIMER

- OFF timer and ON timer can be used in combination.
- “↑” and “↓” display shows the order of OFF timer and ON timer operation.

(Example 1) The current time is 8:00 PM.
The unit turns off at 11:00 PM, and on at 6:00 AM.

(Example 2) The current time is 11:00 AM.
The unit turns on at 5:00 PM, and off at 9:00 PM.

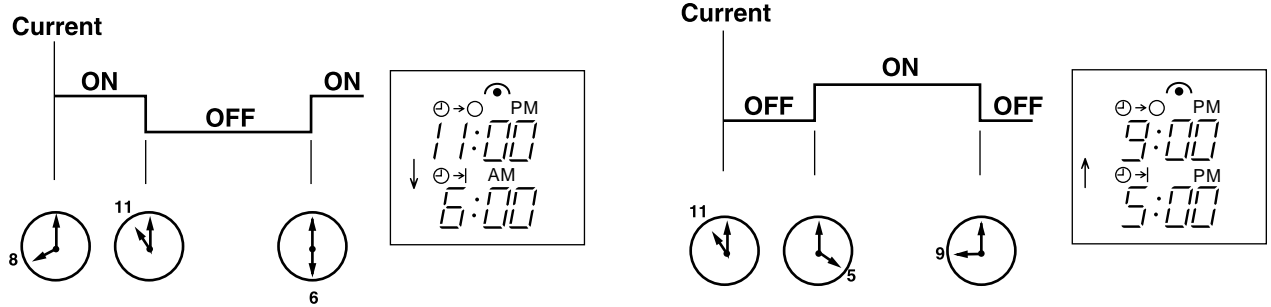

NOTE : TIMER setting will be cancelled by power failure or breaker functioning.

2-8. EMERGENCY / TEST OPERATION

In case of test run operation or emergency operation, use EMERGENCY OPERATION switch on the front of the indoor unit. Emergency operation is available when the remote controller is missing, has failed or the batteries of remote controller run down. The unit will start and OPERATION INDICATOR lamp will light.

The first 30 minutes of operation is the test run operation. This operation is for servicing. The indoor fan speed runs at High speed and the system is in continuous operation. (The thermostat is ON.)

After 30 minutes of test run operation, the system shifts to EMERGENCY COOL MODE with a set temperature of 24°C. The fan speed shifts to Med. speed.

The coil frost prevention works even in emergency operation.

In the test run or emergency operation, the horizontal vane operates in VANE AUTO (@) mode.

Emergency operation continues until EMERGENCY OPERATION switch is pressed again or the unit receives any signal from the remote controller. In case of latter, normal operation will start.

NOTE : Do not press EMERGENCY OPERATION switch during normal operation.

- The following indication applies regardless of shape of the indicator.

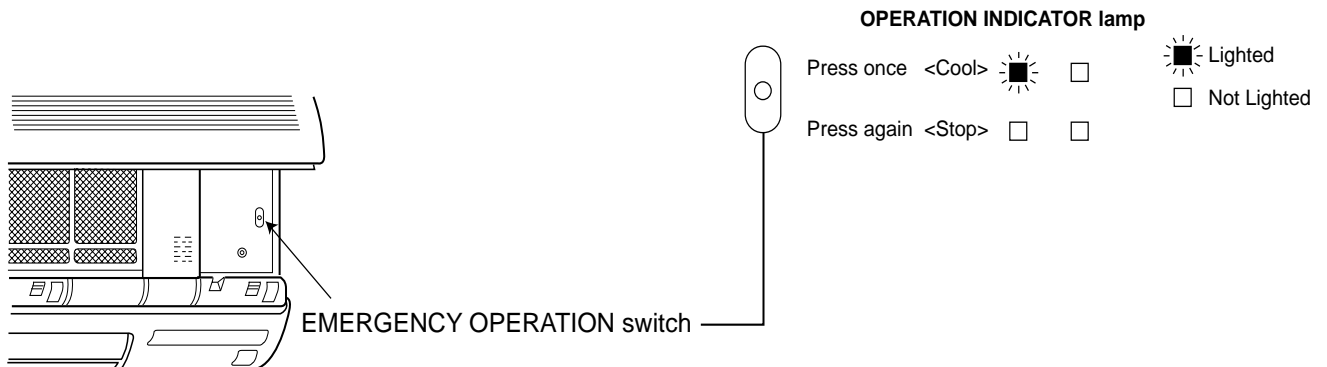

2-9. EXPANSION VALVE CONTROL (LEV CONTROL) <MU-GA80VB>

LEV (Expansion valve) is controlled by "Thermostat ON" commands given from the unit.

Basic specification	Controlled range	Minimum : 54 pulse, Maximum : 500 pulse
	Drive speed	30 ~ 90 pulse / second
	Opening set	The setting is always in opening direction. (To close the LEV, it is closed to the pulse smaller than the one which is set finally. Then the LEV is opened to the final setting pulse.)
General operation	Stop of indoor unit	Opening in stop : 150 pulse → LEV opening is set to becomes 500 pulse after 3 minutes passed.
	Remote controller ON	LEV positioning (LEV is closed completely at once)
	Power ON (Breaker ON)	LEV is positioned. However, afterwards, LEV is not positioned at the first remote controller ON.
	Approximate for 2 minutes since compressor has started.	Opening is set by the initial opening. (Initial opening is set according to each operation modes and outer temperature conditions.)
	From approximate 2 minutes to approximate 13 minutes (for 11 minutes) since compressor has started.	Opening is set by standard opening. (Standard opening is set according to each operation modes and outer temperature conditions.)
	After 13 minutes passed since compressor has started.	LEV opening is corrected to be once every 2 minutes so that discharge temperature becomes the target discharge temperature. (When the discharge temperature is lower than target : LEV is corrected in closed direction, when the discharge temperature is higher than target : LEV is corrected in opening direction.)
	At thermostat OFF	Opening in stop : 150 pulse → LEV is set to the initial opening after about 3 minutes passed.
	At thermostat ON	Same as the starting of compressor operation
	At remote controller OFF	Opening in stop : 150 pulse → LEV is set so that the opening is opened completely at the speed of 4 pulse every 5 seconds in opening after about 3 minutes passed.

(1) LEV opening correction by discharge temperature

The LEV opening is corrected according to the temperature difference between target discharge temperature (Tb) and actual discharge temperature (Ta).

① The LEV correction is used properly for two kinds according to the LEV opening status at operation off.

Rank	Opening immediately before having stopped last time	
	100 pulse or less	100 pulse or more
Ta (°C)	Cooling	Cooling
more than Tb+10	5	20
Tb+5 to Tb+10	2	10
Tb+2 to Tb+5	1	2
Tb-2 to Tb+2	0	0
Tb-5 to Tb-2	-1	-2
Tb-10 to Tb-5	-2	-5
less than Tb-10	-5	-10

NOTE : Discharge temperature : Ta, Target discharge temperature : Tb

- ② When the temperature difference ΔRT between indoor coil thermistor (main) RT12 and indoor coil thermistor (sub) RT13 in the indoor unit is 2°C or more for a fixed time at cool or dry operation, the target discharge temperature is changed. After the temperature is changed, when temperature difference ΔRT is 3°C or more, the target temperature is changed again. The LEV opening is controlled based on the changed target discharge temperature and the temperature difference ΔRT .

Ta (°C)	ΔRT		
	less than 2°C	2°C or more and less than 3°C	3°C or more
more than Tb+10	20	60	60
Tb+5 to Tb+10	10	20	20
Tb+2 to Tb+5	2	2	2
Tb-2 to Tb+2	0	0	0
Tb-5 to Tb-2	-2	-2	-2
Tb-10 to Tb-5	-5	-5	-5
less than Tb-10	-10	-10	-10

NOTE : Discharge temperature : Ta, Target discharge temperature : Tb

The target discharge temperature (Tb) is set according to the operation mode or the unit status as follows.

Operation mode	Tb (°C)
COOL (Normal)	80
COOL (ΔRT is less than 2°C, or ΔRT is 2°C or more and less than 3°C.)	70
COOL (ΔRT is 3°C or more.)	65

NOTE : Target discharge temperature : Tb

- NOTE :** When the discharge temperature (Ta) is 50°C or less on the cool operation LEV opening is set in 54 pulse. When this state continues for 20 minutes, the compressor is stopped and restarts in 3 minutes. When the compressor is stopped, the indoor unit indicates the abnormality of refrigerant system and stops. (OPERATION INDICATOR lamp is 10-time flashing on and off.)

(2) LEV time chart

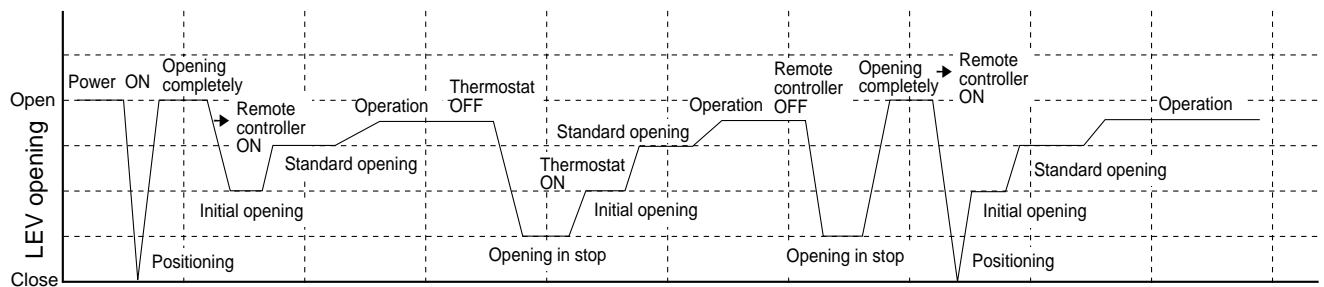

NOTE : Opening increases and decreases to be in the target discharge temperature during operation.

2-10. FUNCTION OF SOFT START RELAY

Soft start relay will chop some starting current. Starting current is reduced as shown in the following figures.

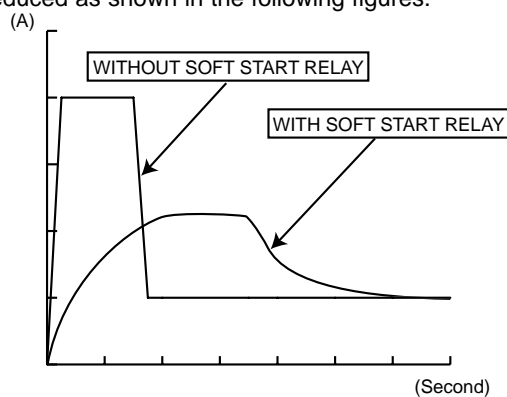

MSH-CA50VB MSH-GA50VB MUH-GA50VB
 MSH-CB50VB MSH-GA60VB MUH-GA60VB
 MSH-GA80VB MUH-GA80VB

WIRELESS REMOTE CONTROLLER

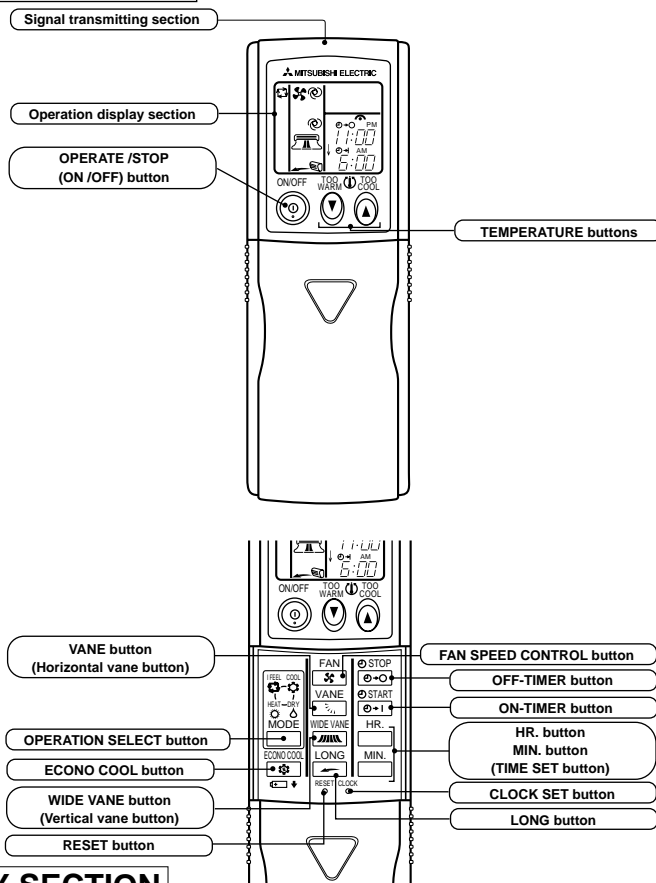

INDOOR UNIT DISPLAY SECTION

Operation Indicator lamp

The operation indicator at the right side of the indoor unit indicates the operation state.

- The following indication applies regardless of shape of the indicator.

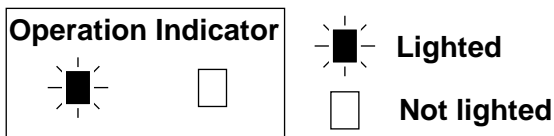



Once the operation mode is set, the same operation mode can be repeated by simply turning OPERATE/STOP (ON/OFF) button ON.

Indoor unit receives the signal with a beep tone.

When the system turns off, 3-minute time delay will operate to protect system from overload and compressor will not restart for 3 minutes.

3-1. "I FEEL CONTROL" () OPERATION

- Press OPERATE/STOP (ON/OFF) button on the remote controller. OPERATION INDICATOR lamp of the indoor unit turns on with a beep tone.
- Select "I FEEL CONTROL" mode with OPERATION SELECT button.
- The operation mode is determined by the room temperature at start-up of the operation.

Indication	Operation state	Difference between target temperature and room temperature
	This shows that the air conditioner is operating to reach the target temperature. Please wait until the target temperature is obtained.	Approx. 2 °C or more
	This shows that the room temperature is approaching the target temperature.	Approx. 2 °C or less

Initial room temperature	Mode
25°C or more	COOL mode of "I FEEL CONTROL"
23°C to 25°C	DRY mode of "I FEEL CONTROL"
less than 23°C	HEAT mode of "I FEEL CONTROL"

- Once the mode is fixed, the mode does not change by room temperature afterwards.
- Under ON-TIMER (⊖→|) operation, mode is determined as follows.

When the system is stopped on the remote controller, and restarted within 2 hours in "I FEEL CONTROL" (□) mode, the system operates in previous mode automatically regardless of the room temperature.

Operation time chart

Example

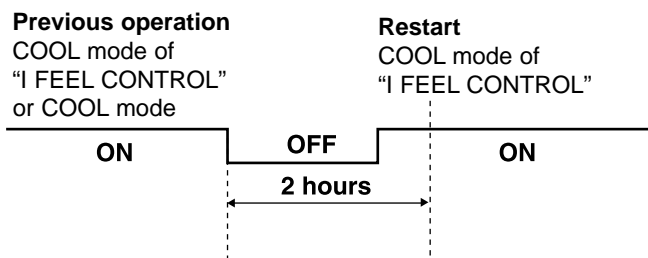

When the system is restarted after 2 hours and more, the operation mode is determined by the room temperature at start-up of the operation.

Operation time chart

Example

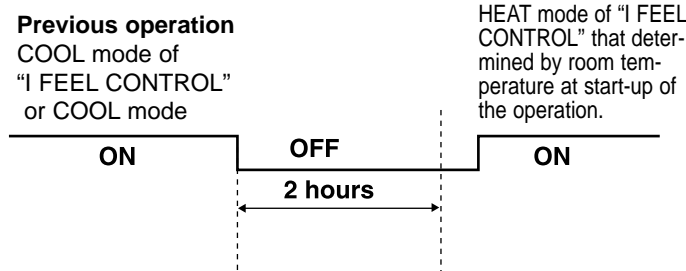

(4) The initial set temperature is decided by the initial room temperature.

Model	Initial room temperature	Initial set temperature	
COOL mode of "I FEEL CONTROL"	26°C or more	24°C	※1
	25°C to 26°C	Initial room temperature minus 2°C	
DRY mode of "I FEEL CONTROL"	23°C to 25°C	Initial room temperature minus 2°C	
HEAT mode of "I FEEL CONTROL"	less than 23°C	26°C	

※1 When the system is restarted with the remote controller, the system operates with the previous set temperature regardless of room temperature at restart.
The set temperature is calculated by the previous set temperature.

(5) TEMPERATURE buttons

In "I FEEL CONTROL" (□) mode, set temperature is decided by the microprocessor based on the room temperature. In addition, set temperature can be controlled by TOO WARM or TOO COOL buttons when you feel too cool or too warm. Each time TOO WARM or TOO COOL button is pressed, the indoor unit receives the signal and emits a beep tone.

• Fuzzy control

When TOO COOL or TOO WARM button is pressed, the microprocessor changes the set temperature, considering the room temperature, the frequency of pressing TOO COOL or TOO WARM button and the user's preference to heat or cool. So this is called "Fuzzy control", and works only in "I FEEL CONTROL" mode.

In DRY mode of "I FEEL CONTROL", the set temperature doesn't change.



...To raise the set temperature 1~2°C



...To lower the set temperature 1~2°C

3-1-1. COOL mode of "I FEEL CONTROL"

1. Indoor fan speed control

Indoor fan operates at the set speed by FAN SPEED CONTROL button.
In AUTO the fan speed is as follows.

Initial temperature difference	Fan Speed
Room temperature minus set temperature : 1.7 °C or more	High
Room temperature minus set temperature : Between 1 and 1.7 °C	Med.
Room temperature minus set temperature : less than 1 °C	Low

Difference between room temperature and set temperature during operation

2. Coil frost prevention

① Temperature control

When the indoor coil thermistor RT12 reads 1°C or below(MSH-CA50/CB50/GA50VB) / -1°C or below(MSH-GA60VB)/ RT12 or RT13 reads 1°C or below (MSH-GA80VB), the coil frost prevention mode starts immediately.

However, the coil frost prevention doesn't work for 5 minutes since the compressor has started.

The indoor fan operates at the set speed and the compressor stops for 5 minutes.

After that, if RT12 still reads below 1°C(MSH-CA50/CB50/GA50VB)/ -1°C(MSH-GA60VB)/ RT12 or RT13 still reads below 1°C (MSH-GA80VB) this mode prolonged until RT12 reads over 1°C(MSH-CA50/CB50/GA50VB)/ -1°C(MSH-GA60VB) / RT12 or RT13 still reads over 1°C(MSH-GA80VB).

② Time control

When the three conditions as follows have been satisfied for 1 hour and 45 minutes, compressor stops for 3 minutes.

a. Compressor has been continuously operating.

b. Indoor fan speed is Low or Med.

c. Room temperature is below 26°C.

When compressor stops, the accumulated time is cancelled and when compressor restarts, time counting starts from the beginning.

Time counting also stops temporarily when the indoor fan speed becomes High or the room temperature exceeds 26°C. However, when two of the above conditions (b.and c.) are satisfied again. Time accumulation is resumed.

Operation chart

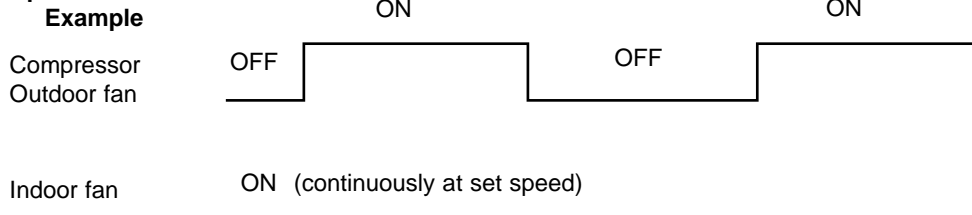

3. Outdoor fan speed control <MUH-GA80VB>

Outdoor fan speed is controlled according to the temperature of ambient temperature thermistor RT63.

Outdoor fan Low operation : When the outside temperature decreases to 20°C or less.

Until the outside temperature goes to 22°C.

Outdoor fan High operation : Until the outside temperature decreases to 20°C or less.

When the outside temperature goes to 22°C.

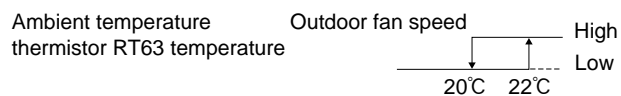

NOTE1 : If the temperature of RT63 reads from 20°C to 22°C at the air conditioner starting outdoor fan speed is High.

NOTE2 : When indoor fan speed is Low except HEAT operation mode and the outside temperature is 30°C or less, the outdoor fan operates at Low.

Outdoor fan Low operation is cancelled according to the following conditions(① or ②):

① When the operation is not changed and the outside temperature goes to 33°C or more.

② When the operation is changed. (Change to HEAT operation mode / Change of the indoor fan speed)

4. Discharge temperature protection <MUH-GA80VB>

The compressor is controlled by the temperature of discharge temperature thermistor RT62 for excess rise protection of compressor discharge pressure.

• Compressor

When the temperature of discharge temperature thermistor RT62 goes to 120°C or more, the compressor is turned OFF.

After 3 minutes since the compressor has been turned OFF, if the temperature of discharge temperature thermistor RT62 becomes 100°C or less, the compressor is turned ON.

3-1-2. DRY mode of "I FEEL CONTROL"

The system for dry operation uses the same refrigerant circuit as the cooling circuit.

The compressor and the indoor fan are controlled by the room temperature.

By such controls, indoor flow amounts will be reduced in order to lower humidity without much room temperature decrease.

1. Indoor fan speed control

Indoor fan operates at the set speed by FAN SPEED CONTROL button.

However, in AUTO fan operation, fan speed becomes Low.

2. The operation of the compressor and indoor/ outdoor fan

Compressor operates by room temperature control and time control.

Set temperature is controlled to fall 2°C from initial room temperature.

Indoor fan and outdoor fan operate in the same cycle as the compressor.

•When the room temperature is 23°C or over:

When the thermostat is ON, the compressor repeats 8 minutes ON and 3 minutes OFF.

When the thermostat is OFF, the compressor repeats 4 minutes OFF and 1 minute ON.

•When the room temperature is under 23°C.

When the thermostat is ON, the compressor repeats 2 minutes ON and 3 minutes OFF.

When the thermostat is OFF, the compressor repeats 4 minutes OFF and 1 minute ON.

Operation time chart

Example

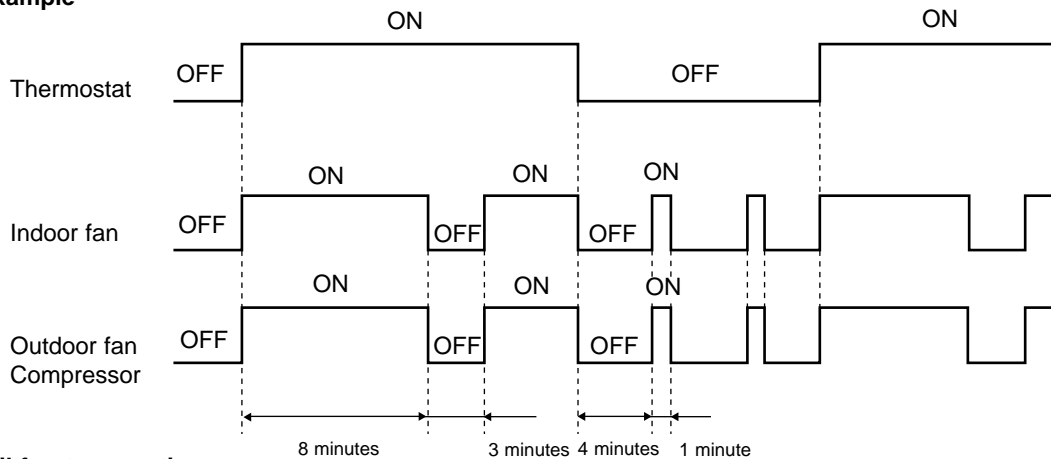

3. Coil frost prevention

• The operation is as same as coil frost prevention during COOL mode of "I FEEL CONTROL".

• Indoor fan operates at the set speed and the compressor stops for 5 minutes, because protection(Coil frost prevention) has the priority.

However, when coil frost prevention works while the compressor is not operating, its speed becomes Low.

4. Outdoor fan speed control <MUH-GA80VB>

Outdoor fan speed is as same as one of COOL mode of "I FEEL CONTROL".

3-1-3. HEAT mode of "I FEEL CONTROL"

1. Indoor fan speed control

(1) In AUTO the fan speed is as follows.

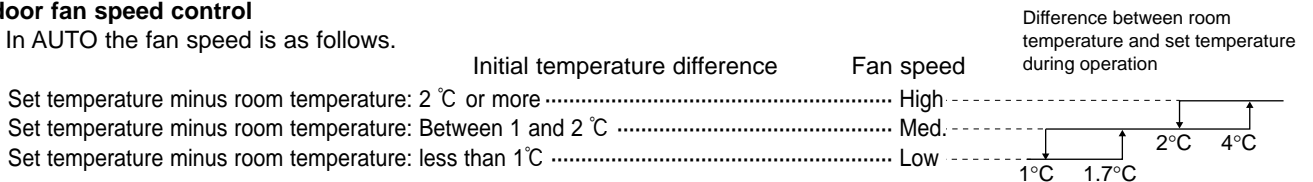

(2) Cold air prevention control

The fan runs at set speed when the indoor coil thermistor RT12 temperature exceeds 22°C. The fan operates Low when the temperature of indoor coil thermistor RT12 is below 18°C. But the fan stops when the indoor fan operates at Very Low and the room temperature is 15°C or less.

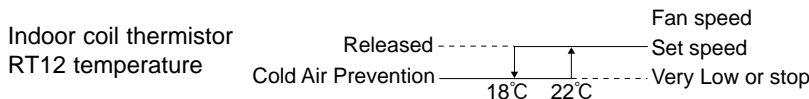

NOTE : If the temperature of RT12 reads from 18°C to 22°C at the air conditioner starting and also after defrosting, this control works.

(3) Warm air control

When compressor starts in heating operation or after defrosting, the fan changes the speed due to the indoor coil thermistor RT12 temperature to blow out warm air. After releasing of cold air prevention, when the indoor coil thermistor RT12 temperature is 37°C or above, the fan speed shifts to the set speed, and when the fan speed is changed by the remote controller, the fan speed is the set speed. When the indoor coil thermistor RT12 temperature is less than 37°C, the fan speed is controlled by time as below.

<Time condition>	<Indoor fan speed>
less than 2 minutes.....	Low
2 minutes to 4 minutes.....	Med.
4 minutes or more.....	High

The upper limit of the fan speed is the set speed.
If the thermostat turns off, this operation changes to flow soft control.

(4) Flow soft control

After the thermostat turns off, the indoor fan operates at Very Low.

NOTE : When the thermostat turns on, the fan operates at the set speed. Due to the cold air prevention control, the fan does not start at set speed until the indoor coil thermistor RT12 reads 22°C or more.

2. Outdoor fan speed control <MUH-GA80VB>

Outdoor fan speed is controlled according to the temperature of ambient temperature thermistor RT63.

Outdoor fan Low operation : Until the outside temperature decreases to 13°C.
When the outside temperature goes to 18°C or more.

Outdoor fan High operation : When the outside temperature decreases to 13°C or less.
Until the outside temperature goes to 18°C.

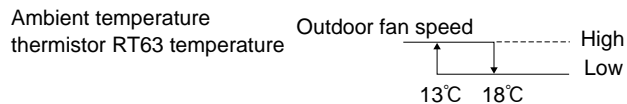

3. High pressure protection <MUH-GA50/60VB>

During heating operation, the outdoor fan motor is controlled by the temperature of indoor coil thermistor RT12 for excess rise protection of compressor discharge pressure.

(MUH-GA50VB) Outdoor fan OFF	: 52°C
Outdoor fan ON	: 48°C
(MUH-GA60VB) Outdoor fan OFF	: 58°C
Outdoor fan ON	: 55°C

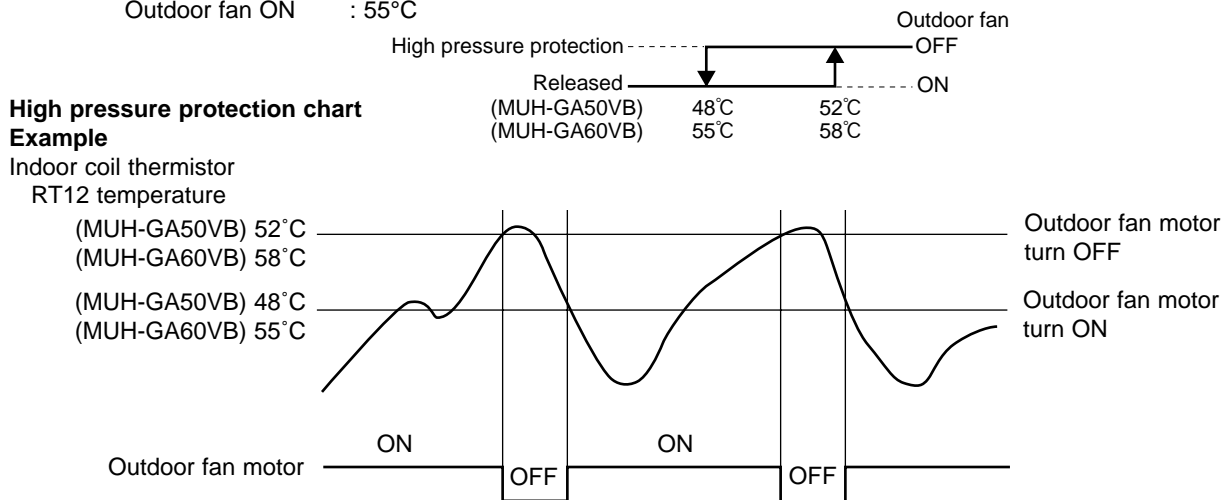

NOTE : During high pressure protection and for 4 minutes and 15 seconds after high pressure protection, defrosting of outdoor heat exchanger is not detected by the defrost thermistor RT61.

<MUH-GA80VB>

During heating operation, the outdoor fan and the compressor are controlled by the temperature of indoor coil thermistor RT12 for excess rise protection of compressor discharge pressure.

- Outdoor fan
When the temperature of indoor coil thermistor RT12 goes to 55°C or more, the outdoor fan is turned OFF.
When the temperature of indoor coil thermistor RT12 becomes to 52°C or less, the outdoor fan is turned ON.
- Compressor
When the temperature of indoor coil thermistor RT12 goes to 75°C or more, the compressor is turned OFF.
3 minutes after the compressor is turned OFF and if the temperature of indoor coil thermistor RT12 becomes 75°C or less, the compressor is turned ON.

NOTE : During the high pressure protection and for 10 seconds after high pressure protection, defrosting of outdoor heat exchanger is not detected by the defrost thermistor RT61.

4. Discharge temperature protection <MUH-GA80VB>

Discharge temperature protection is as same as during COOL mode of "I FEEL CONTROL".

5. Defrosting

Defrosting of outdoor heat exchanger is controlled by deicer P.C. board, with detection by the defrost thermistor RT61.

(1) Starting conditions of defrost

When all conditions of a) ~ c) are satisfied, the defrosting operation starts.

- a) Under the heat operation, the compressor cumulative operation time exceeds 40 minutes without the defrosting operation working.
- b) The defrost thermistor RT61 reads -3°C or less.
- c) After releasing the high pressure protection 4 minutes and 15 seconds(MUH-GA50/GA60VB) / 10 seconds (MUH-GA80VB) have elapsed.

(2) Releasing conditions of defrost

When the condition d) or e) is satisfied, the defrosting operation stops.

- d) The defrost thermistor RT61 reads 3°C(MUH-GA50/GA60VB)/ 13°C(MUH-GA80VB) or more.
- e) The defrosting time exceeds 10 minutes.

(3) Defrosting time chart

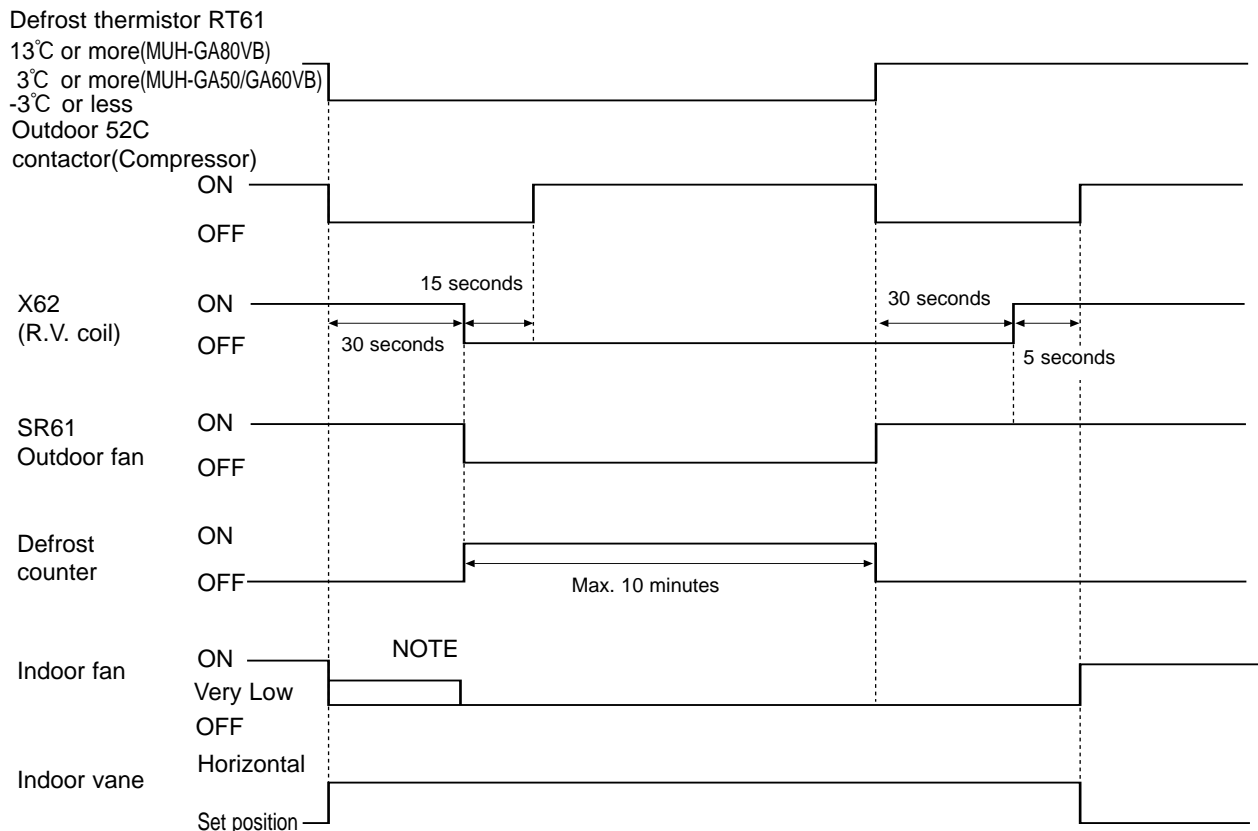

NOTE: • When the indoor coil thermistor RT12 reads above 18°C, indoor fan operates at Very Low for 30 seconds.
• When the indoor coil thermistor RT12 reads 18°C or less, the indoor fan stops.

3-2. COOL (❄) OPERATION

- (1) Press OPERATE/STOP (ON/OFF) button.
OPERATION INDICATOR lamp of the indoor unit turns on with a beep tone.
- (2) Select COOL mode with OPERATION SELECT button.
- (3) Press TEMPERATURE buttons.
(TOO WARM or TOO COOL button) to select the desired temperature.
The setting range is 16 ~ 31°C.
* Indoor fan continues to operate regardless of thermostat's OFF-ON at set speed.
* Coil frost prevention is as same as COOL mode of "I FEEL CONTROL".

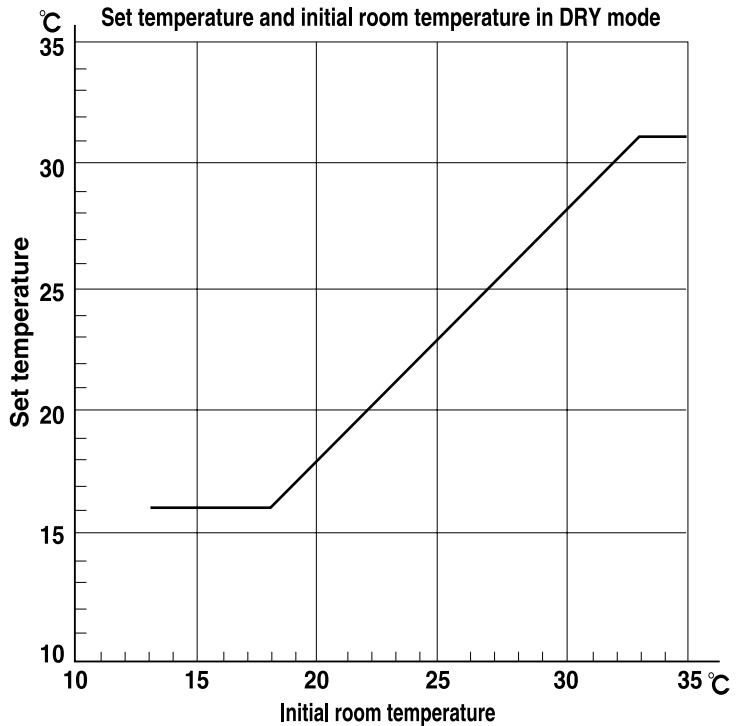

3-3. DRY (△) OPERATION

- (1) Press OPERATE/STOP (ON/OFF) button.
OPERATION INDICATOR lamp of the indoor unit turns on with a beep tone.
- (2) Select DRY mode with OPERATION SELECT button.
- (3) The microprocessor reads the room temperature and determines the set temperature. Set temperature is as shown on the right chart. Thermostat (SET TEMP.) does not work. The other operations are same as DRY mode of "I FEEL CONTROL".
- (4) DRY operation will not function when the room temperature is 13°C or below.

3-4. HEAT (☀) OPERATION

- (1) Press OPERATE/STOP (ON/OFF) button.
OPERATION INDICATOR lamp of the indoor unit turns on with a beep tone.
- (2) Select HEAT mode with OPERATION SELECT button.
- (3) Press TEMPERATURE buttons (TOO WARM or TOO COOL button) to select the desired temperature.
The setting range is 16 ~ 31°C.
- (4) Indoor fan speed control, high pressure protection, defrosting, R.V. coil control are the same as HEAT mode of "I FEEL CONTROL".

3-5. INDOOR FAN MOTOR CONTROL

- (1) Rotational frequency feedback control
The indoor fan motor is equipped with a rotational frequency sensor, and outputs signal to the microprocessor to feedback the rotational frequency. Comparing the current rotational frequency with the target rotational frequency (High, Med., Low), the microprocessor controls SR141 and adjusts fan motor electric current to make the current rotational frequency close to the target rotational frequency. With this control, when the fan speed is switched, the rotational frequency changes smoothly.

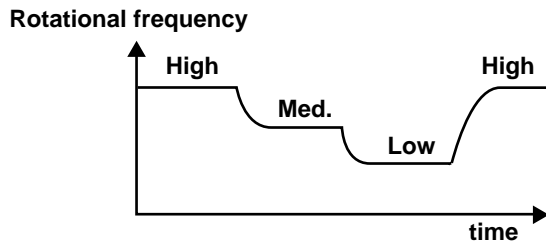

- (2) Fan motor lock-up protection
When the rotational frequency feedback signal has not output for 12 seconds, (or when the microprocessor cannot detect the signal for 12 seconds) the fan motor is regarded locked-up. Then the electric current to the fan motor is shut off. 3 minutes later, the electric current is applied to the fan motor again. During the fan motor lock-up, the OPERATION INDICATOR Indicator lamp flashes on and off to show the fan motor abnormality.

3-6. AUTO VANE OPERATION

1. Horizontal vane

(1) Vane motor drive

These models are equipped with a stepping motor for the horizontal vane. The rotating direction, speed, and angle of the motor are controlled by pulse signals (approx. 12V) transmitted from indoor microprocessor.

(2) The horizontal vane angle and mode change as follows by pressing the VANE button.

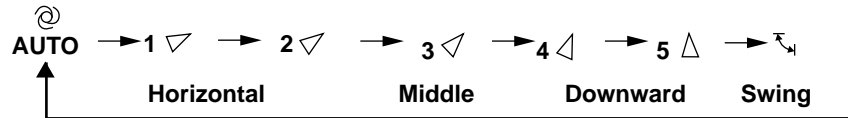

(3) Positioning

The vane presses the vane stopper once to confirm the standard position and then moves to the set angle. Confirming of standard position is performed in case of follows.

- (a) When the power supply turns ON.
- (b) When the operation starts or finishes (including timer operation).
- (c) When the test run starts.
- (d) When the vane control is changed AUTO to MANUAL (except SWING).
- (e) When SWING is finished (including ECONO COOL).
- (f) When multi-standby starts or finishes.

(4) VANE AUTO (Ⓐ) mode

The microprocessor automatically determines the horizontal vane angle and operation to make the optimum room temperature distribution.

COOL and DRY operation
Vane angle is fixed to Angle 1.

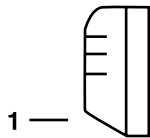

HEAT operation
Vane angle is fixed to Angle 4.

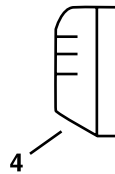

(5) STOP (operation OFF) and ON-TIMER standby

When the following cases occur, the horizontal vane returns to the closed position.

- (a) When OPERATE/STOP (ON/OFF) button is pressed (POWER OFF).
- (b) When the operation is stopped by the emergency operation.
- (c) When ON-TIMER is on standby.

(6) Dew prevention

During COOL or DRY operation at Vane Angle 4 or 5 when the compressor cumulative operation time of compressor exceeds 1 hour, the vane angle automatically changes to Angle 1 for dew prevention.

(7) SWING MODE (Ⓐ)

By selecting SWING mode with VANE button, the horizontal vane swings vertically. The remote controller displays “Ⓐ”. SWING mode is cancelled when VANE button is pressed once again.

(8) Cold air prevention in HEAT operation

When any of the following conditions occurs in HEAT operation, the vane angle changes to Angle 1 automatically to prevent cold air blowing on users.

- ① Compressor is not operating.
- ② Defrosting is performed.
- ③ Indoor coil thermistor RT12 reads 24°C or below.
- ④ Indoor coil thermistor RT12 temperature is raising from 24°C or below, but it does not exceed 28°C.

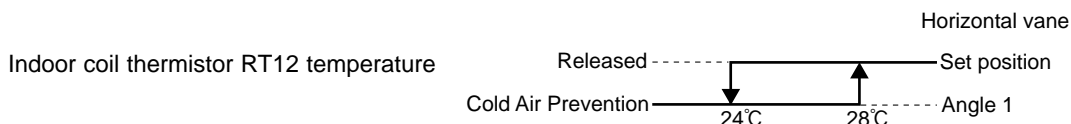

NOTE1: If the temperature of RT12 reads from 24°C to 28°C at the air conditioner starting, this control works.

NOTE2: When 2 or more indoor units are operated with multi outdoor unit, even if any indoor unit turns thermostat off, this control doesn't work in the indoor unit.

(9) ECONO COOL () operation (ECONOMical operation)

When ECONO COOL button is pressed in COOL mode, set temperature is automatically set 2°C higher.

Also the horizontal vane swings in various cycle according to the temperature of indoor heat exchanger(Tp(* 1)).

SWING operation makes you feel cooler than set temperature. So, even though the set temperature is higher, the air conditioner can keep comfort. As a result, energy can be saved.

ECONO COOL operation is cancelled when ECONO COOL button is pressed once again or VANE button is pressed or LONG button is pressed or change to other operation mode.

NOTE : ECONO COOL operation does not work in COOL mode of "I FEEL CONTROL".

<SWING operation>

- * 1 Tp : • Value of RT12 (MSH-CA50/GA50/GA60VB)
- Minimum value of indoor coil thermistor (main) RT12 and indoor coil thermistor (sub) RT13 (MSH-GA80VB)

In swing operation of ECONO COOL operation mode, the initial air flow direction is adjusted to "Horizontal".

According to the temperature of indoor coil thermistor Tp(* 1) at starting of this operation, next downward blow time is decided. Then when the downward blow has been finished, next horizontal blow time is decided.

For initial 10 minutes the swing operation is performed in table G~H for quick cooling.

Also, after 10 minutes when the difference of set temperature and room temperature is more than 2°C, the swing operation is performed in table D~H for more cooling.

The air conditioner repeats the swing operation in various cycle as follows.

	Temperature of Tp(* 1)	Downward blow time (second)	Horizontal blow time (second)
A	15°C or less	2	23
B	15°C to 17°C	5	20
C	17°C to 18°C	8	17
D	18°C to 20°C	11	14
E	20°C to 21°C	14	11
F	21°C to 22°C	17	8
G	22°C to 24°C	20	5
H	more than 24°C	23	2

(10) LONG MODE ()

By pressing LONG button indoor fan speed becomes faster than setting fan speed on the remote controller, and the horizontal vane moves to the position for LONG mode. The remote controller displays "  ". LONG mode is cancelled when LONG button is pressed once again or VANE button is pressed or ECONO COOL button is pressed in COOL mode.

- In the following example, the vertical vane is set to  (front.).

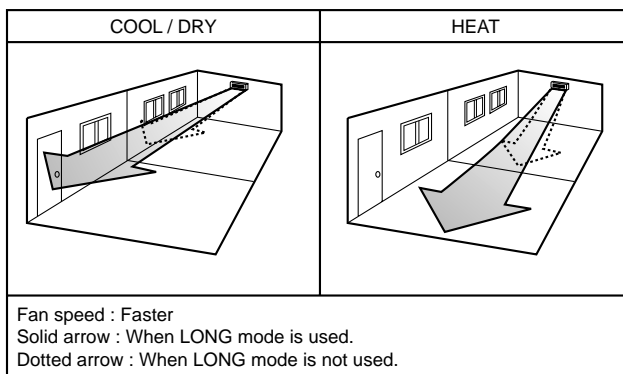

2. Vertical vane

(1) Vane motor drive

These models are equipped with a stepping motor for the vertical vane. The rotating direction, speed, and angle of the motor are controlled by pulse signals (approx. 12V) transmitted from microprocessor.

(2) The vertical vane angle and mode change as follows by pressing the WIDE VANE button.

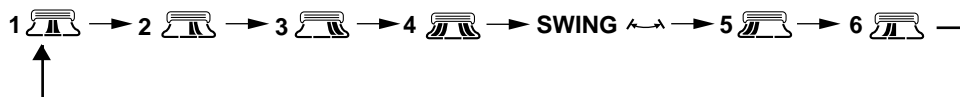

(3) Positioning

The vane is once pressed to the vane stopper to confirm the standard position and then set to the desired angle.

Confirming of standard position is performed in case of follows.

(a) When OPERATE/STOP(ON/OFF) button is pressed (POWER ON/OFF).

(b) When SWING is started or finished.

(c) When the power supply turns ON.

(4) SWING MODE (↔)

By selecting SWING mode with WIDE VANE button, the vertical vane swings horizontally. The remote controller displays "↔". The vane moves right and left in the width of Angle 4 repeatedly.

(5) WIDE MODE (🌀)

By selecting WIDE mode with WIDE VANE button, indoor fan speed becomes faster than setting fan speed on the remote controller (*). The remote controller displays "🌀".

NOTE : The position of vane angle 3, angle 4 and angle 5 are different in COOL operation and HEAT operation.

* Indoor fan speed becomes faster than setting fan speed on the remote controller even when 🌀 or 🌀 is selected.

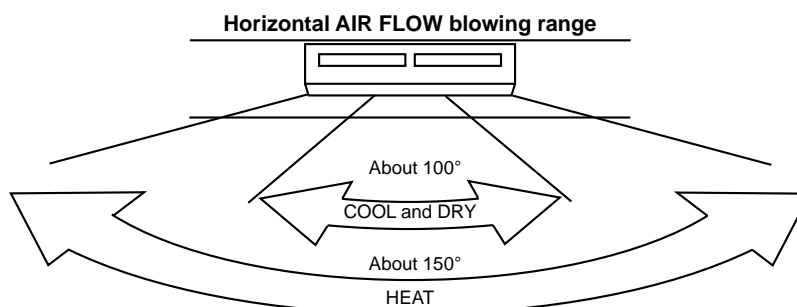

3-7. TIMER OPERATION

1. How to set the timer

(1) Press OPERATE/STOP (ON/OFF) button to start the air conditioner.

(2) Check that the current time is set correctly.

NOTE : Timer operation will not work without setting the current time. Initially "AM0:00" blinks at the current time display of TIME MONITOR, so set the current time correctly with CLOCK SET button.

(3) Press ON/OFF TIMER buttons to select the operation.

"ON-TIMER" button... AUTO START operation (ON timer)

"OFF-TIMER" button... AUTO STOP operation (OFF timer)

(4) Press HR. and MIN. button to set the timer. Time setting is 10-minute units.

HR. and MIN. button will work when "⌚→| " or "⌚→○" mark is flashing.

These marks disappear in 1 minute.

After setting the ON timer, check that OPERATION INDICATOR lamp of the indoor unit lights.

NOTE1 : Be sure to place the remote controller at the position where its signal can reach the air conditioner even during TIMER operation, or the set time may deviate within the range of about 10 minutes.

NOTE2 : Reset the timer in the following cases, or the set time may deviate and other malfunctions may occur.

- A power failure occurs.
- The circuit breaker functions.

2. Cancel

TIMER setting can be cancelled with the ON/OFF TIMER buttons.

To cancel ON timer, press "ON-TIMER" button.

To cancel OFF timer, press "OFF-TIMER" button.

TIMER is cancelled and the display of set time disappears.

PROGRAM TIMER

- OFF timer and ON timer can be used in combination.
- "↑" and "↓" display shows the order of OFF timer and ON timer operation.

(Example 1) The current time is 8:00 PM.

The unit turns off at 11:00 PM, and on at 6:00 AM.

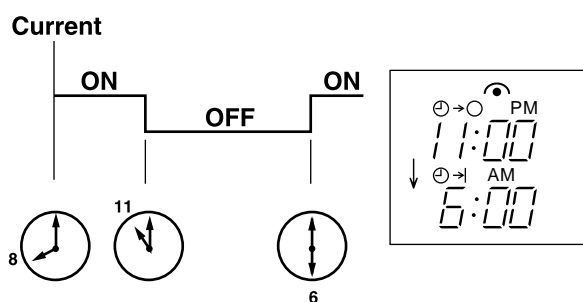

(Example 2) The current time is 11:00 AM.

The unit turns on at 5:00 PM, and off at 9:00 PM.

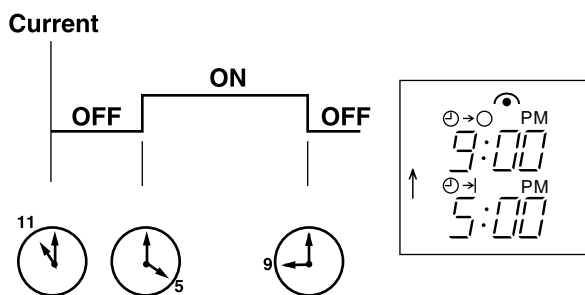

NOTE : TIMER setting will be cancelled by power failure or breaker functioning.

3-8. EMERGENCY / TEST OPERATION

In case of test run operation or emergency operation, use EMERGENCY OPERATION switch on the front of the indoor unit. Emergency operation is available when the remote controller is missing, has failed or the batteries of remote controller run down. The unit will start and OPERATION INDICATOR lamp will light.

The first 30 minutes of operation is the test run operation. This operation is for servicing. The indoor fan speed runs at High speed and the system is in continuous operation. (The thermostat is ON.)

After 30 minutes of test run operation, the system shifts to EMERGENCY COOL / HEAT MODE with a set temperature of 24°C.

The fan speed shifts to Med. speed.

The coil frost prevention works even in emergency operation, and defrosting too.

In the test run or emergency operation, the horizontal vane operates in VANE AUTO (@) mode.

Emergency operation continues until EMERGENCY OPERATION switch is pressed once or twice or the unit receives any signal from the remote controller. In case of latter, normal operation will start.

NOTE : Do not press EMERGENCY OPERATION switch during normal operation.

- The following indication applies regardless of shape of the indicator.

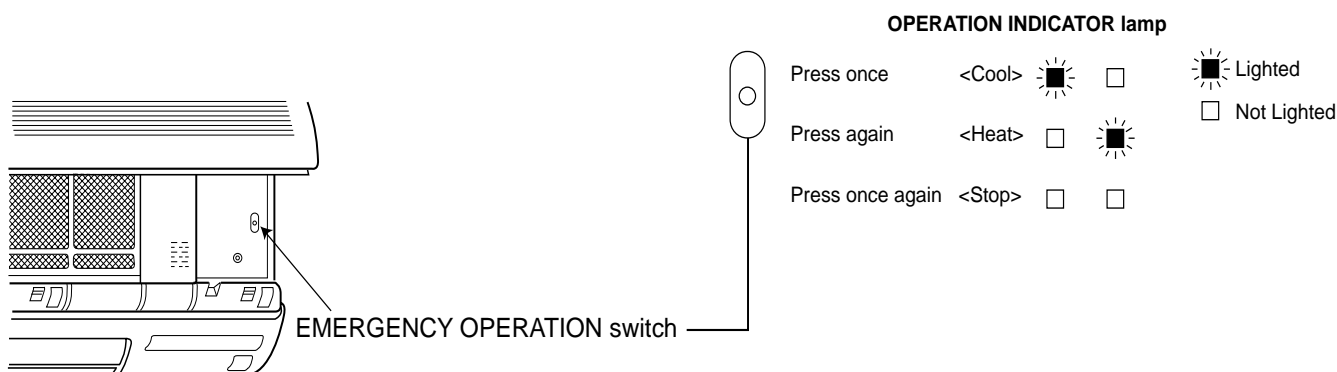

3-9. EXPANSION VALVE CONTROL (LEV CONTROL) <MUH-GA80VB>

LEV (Expansion valve) is controlled by "Thermostat ON" commands given from the unit.

Basic specification	Controlled range	Minimum : 54 pulse, Maximum : 500 pulse
	Drive speed	30 ~ 90 pulse / second
	Opening set	The setting is always in opening direction. (To close the LEV, it is closed to the pulse smaller than the one which is set finally. Then the LEV is opened to the final setting pulse.)
General operation	Stop of indoor unit	Opening in stop : 150 pulse → LEV opening is set to becomes 500 pulse after 3 minutes passed.
	Remote controller ON	LEV positioning (LEV is closed completely at once)
	Power ON (Breaker ON)	LEV is positioned. However, afterwards, LEV is not positioned at the first remote controller ON.
	Approximate for 2 minutes since compressor has started.	Opening is set by the initial opening. (Initial opening is set according to each operation modes and outer temperature conditions.)
	From approximate 2 minutes to approximate 13 minutes (for 11 minutes) since compressor has started.	Opening is set by standard opening. (Standard opening is set according to each operation modes and outer temperature conditions.)
	After 13 minutes passed since compressor has started.	LEV opening is corrected to be once every 2 minutes so that discharge temperature becomes the target discharge temperature. (When the discharge temperature is lower than target one : LEV is corrected in closed direction, when the discharge temperature is higher than target one : LEV is corrected in opening direction.)
	At thermostat OFF	Opening in stop : 150 pulse → LEV is set to the initial opening after about 3 minutes passed.
	At thermostat ON	Same as the starting of compressor operation
	At remote controller OFF	Opening in stop : 150 pulse → LEV is set so that the opening is opened completely at the speed of 4 pulse every 5 seconds in opening after about 3 minutes passed.

(1) LEV opening correction by discharge temperature

The LEV opening is corrected according to the temperature difference between target discharge temperature (Tb) and actual discharge temperature (Ta).

① The LEV correction is used properly for two kinds according to the LEV opening status at operation off.

Rank	Opening immediately before having stopped last time	
	100 pulse or less	100 pulse or more
Ta (°C)	Cooling / Heating	Cooling / Heating
more than Tb+10	5	20
Tb+5 to Tb+10	2	10
Tb+2 to Tb+5	1	2
Tb-2 to Tb+2	0	0
Tb-5 to Tb-2	-1	-2
Tb-10 to Tb-5	-2	-5
less than Tb-10	-5	-10

NOTE : Discharge temperature : Ta, Target discharge temperature : Tb

② When the temperature difference ΔRT between indoor coil thermistor (main) RT12 and indoor coil thermistor (sub) RT13 in the indoor unit is 2°C or more for a fixed time at cool or dry operation, the target discharge temperature is changed. After the temperature is changed, when temperature difference ΔRT is 3°C or more, the target temperature is changed again. The LEV opening is controlled based on the changed target discharge temperature and the temperature difference ΔRT .

Ta (°C)	ΔRT		
	less than 2°C	2°C or more and less than 3°C	3°C or more
more than Tb+10	20	60	60
Tb+5 to Tb+10	10	20	20
Tb+2 to Tb+5	2	2	2
Tb-2 to Tb+2	0	0	0
Tb-5 to Tb-2	-2	-2	-2
Tb-10 to Tb-5	-5	-5	-5
less than Tb-10	-10	-10	-10

NOTE : Discharge temperature : Ta, Target discharge temperature : Tb
 The target discharge temperature (Tb) is set according to the operation mode or the unit status as follows.

Operation mode	Tb (°C)
HEAT	85
COOL (Normal)	80
COOL (ΔRT is less than 2°C, or ΔRT is 2°C or more and less than 3°C.)	70
COOL (ΔRT is 3°C or more.)	65

NOTE : Target discharge temperature : Tb

NOTE : When the discharge temperature (Ta) is 50°C or less on the cool operation, or is 49°C or less on heat operation, LEV opening is set in 54 pulse.
 When this state continues for 20 minutes, the compressor is stopped and restarts in 3 minutes.
 When the compressor is stopped, the indoor unit indicates the abnormality of refrigerant system and stops. (OPERATION INDICATOR lamp is 10-time flashing on and off.)

(2) LEV time chart

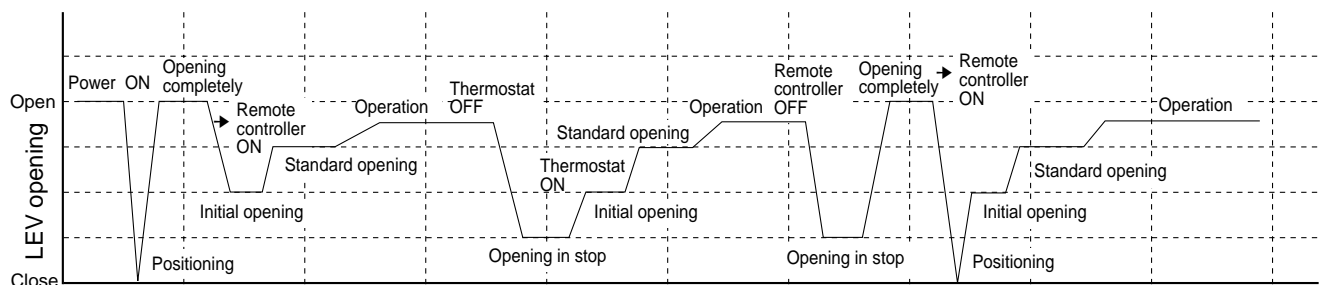

NOTE : Opening increases and decreases to be in the target discharge temperature during operation.

3-10. FUNCTION OF SOFT START RELAY

Soft start relay will chop some starting current. Starting current is reduced as shown in the following figures.

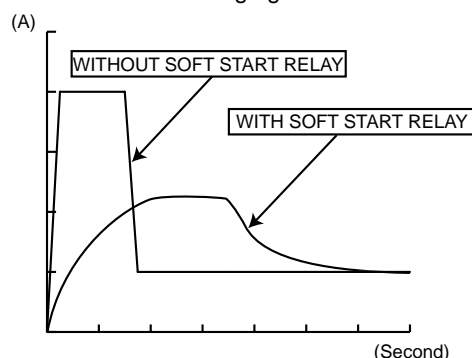

**MSZ-CA25VB MUZ-CA25VB
MSZ-CA35VB MUZ-CA35VB**

WIRELESS REMOTE CONTROLLER

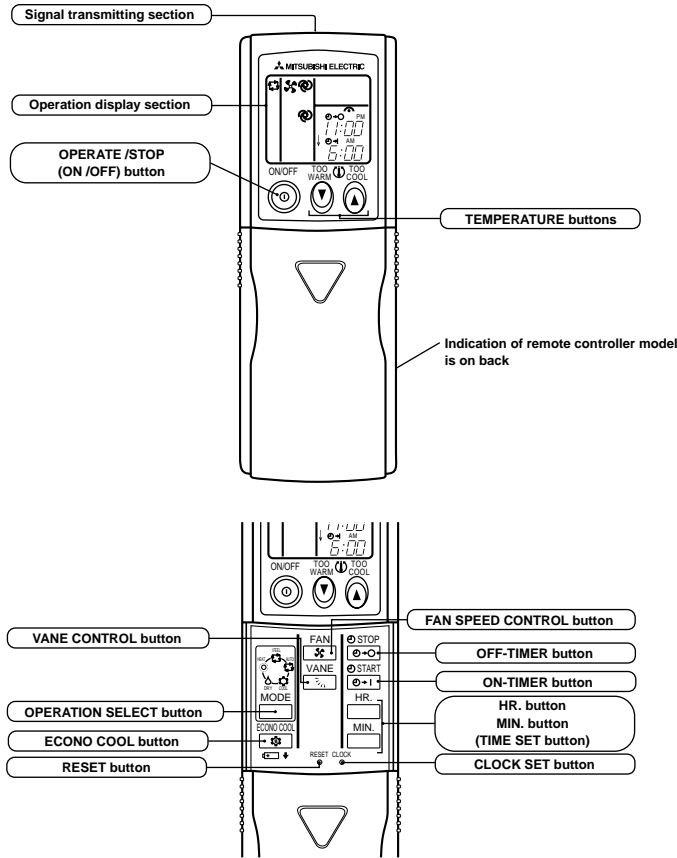

INDOOR UNIT DISPLAY SECTION

Operation Indicator lamp

The operation indicator at the right side of the indoor unit indicates the operation state.

•The following indication applies regardless of shape of the indicator.

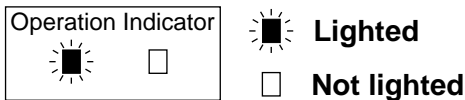

Indication	Operation state	Difference between target temperature and room temperature
	This shows that the air conditioner is operating to reach the target temperature. Please wait until the target temperature is obtained.	Approx. 2 °C or more
	This shows that the room temperature is approaching the target temperature.	Approx. 2 °C or less

Once the operation mode is set, the same operation mode can be repeated by simply turning OPERATE/STOP (ON/OFF) button ON.

Indoor unit receives the signal with a beep tone. When the system turns off, 3-minute time delay will operate to protect system from overload and compressor will not restart for 3 minutes.

4-1. "I FEEL CONTROL" (□) OPERATION

1. Press OPERATE/STOP(ON/OFF) button on the remote controller. OPERATION INDICATOR lamp of the indoor unit will turn on with a beep tone.
2. Select "I FEEL CONTROL"(□) mode with OPERATION SELECT button.
3. The operation mode is determined by the room temperature at start-up of the operation.

Initial room temperature	Mode
25°C or more	COOL mode of "I FEEL CONTROL"
23°C to 25°C	DRY mode of "I FEEL CONTROL"
less than 23°C	HEAT mode of "I FEEL CONTROL"

- Once the mode is fixed, the mode does not change by room temperature afterwards.
- Under ON-TIMER (⊕—|) operation, mode is determined as follows.

When the system is stopped on the remote controller, and restarted within 2 hours in "I FEEL CONTROL" (□) mode, the system operates in previous mode automatically regardless of the room temperature.

Operation time chart

Example

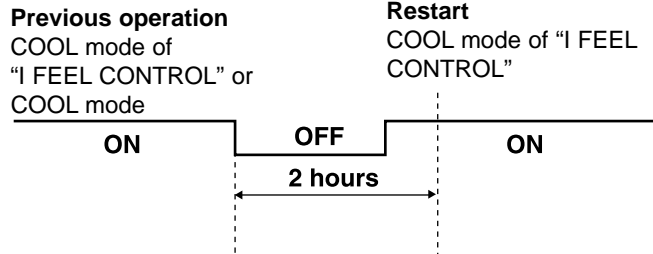

When the system is restarted after 2 hours and more, the operation mode is determined by the room temperature at start-up of the operation.

Operation time chart

Example

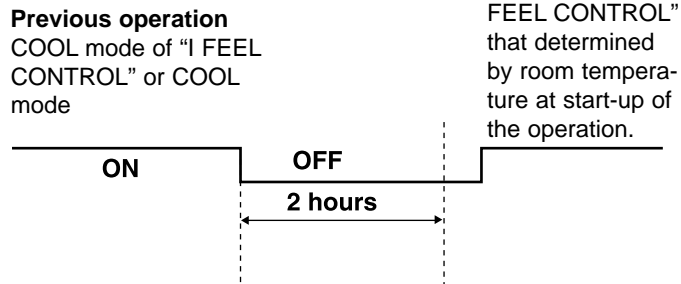

4. The initial set temperature is decided by the initial room temperature.

Model	Initial room temperature	Initial set temperature	
COOL mode of "I FEEL CONTROL"	26°C or more	24°C	*1
	25°C to 26°C	Initial room temperature minus 2°C	
DRY mode of "I FEEL CONTROL"	23°C to 25°C	Initial room temperature minus 2°C	
HEAT mode of "I FEEL CONTROL"	less than 23°C	26°C	

*1 When the system is restarted with the remote controller, the system operates with the previous set temperature regardless of the room temperature at restart.

The set temperature is calculated by the previous set temperature.

5. TEMPERATURE buttons

In "I FEEL CONTROL" (□) mode, set temperature is decided by the microprocessor based on the room temperature. In addition, set temperature can be controlled by TOO WARM or TOO COOL buttons when you feel too cool or too warm. Each time TOO WARM or TOO COOL button is speed, the indoor unit receives the signal emits a beep tone.

- Fuzzy control

When TOO COOL or TOO WARM button is pressed, the microprocessor changes the set temperature, considering the room temperature, the frequency of pressing TOO COOL or TOO WARM button and the user's preference to heat or cool. So this is called "Fuzzy control", and works only in "I FEEL CONTROL" mode.

In DRY mode of "I FEEL CONTROL", the set temperature doesn't change.



...To raise the set temperature 1 ~ 2°C



...To lower the set temperature 1 ~ 2°C



4-1-1. COOL mode of “I FEEL CONTROL”

1. Thermostat control

Thermostat is ON or OFF by difference between room temperature and set temperature

Difference between room temperature and set temperature during operation.

	Initial temperature difference	Thermostat	Set temperature
Room temperature minus set temperature : 0.3 °C or more.....		ON	
Room temperature minus set temperature : less than -0.3 °C.....		OFF	

2. Indoor fan speed control

Indoor fan operates continuously at the set speed by FAN SPEED CONTROL button regardless of the thermostat's OFF-ON.
In AUTO the fan speed is as follows.

Difference between room temperature and set temperature during operation (Δ T)

	Initial temperature difference	Fan speed	
Room temperature minus set temperature : 1.7 °C or more.....		High	
Room temperature minus set temperature : Between 1 and 1.7 °C.....		Med.	
Room temperature minus set temperature : less than 1 °C.....		Low	

*In case that Δ T has been any following condition for 30 minutes, the value in the parentheses is applied.

- a. Fan speed is Auto Low, and Δ T is 1 °C or more.
- b. Fan speed is Auto Med., and Δ T is 1.7 °C or more.

3. Coil frost prevention

① Temperature control

The operational frequency of the compressor is controlled based on the temperature of the indoor coil thermistor.

Temperature of indoor coil thermistor	Operation frequency
8°C or more	Normal (variable)
6°C to 8°C	Fixed
3°C to 6°C	Lower at the rate of 3 Hz / 90 seconds
3°C or less	Lower at the rate of 6 Hz / 90 seconds Compressor is turned OFF for 5 minutes when temperature of indoor coil thermistor continues 3°C or less for 5 minutes or more.

The indoor fan maintains the actual speed of the moment.

② Time control

When the three conditions as follows have been satisfied for 1 hour and 45 minutes, compressor stops for 3 minutes. The indoor fan operates at set speed.

- a. Compressor has been continuously operating.
- b. Indoor fan speed is Low or Med.
- c. Room temperature is below 26°C.

When compressor stops, the accumulated time is cancelled. When compressor restarts, time counting starts from the beginning.

Time counting also stops temporarily when the indoor fan speed becomes High or the room temperature exceeds 26°C. However, when two of the above conditions(b and c.) are satisfied again. Time accumulation is resumed.

4. Low outside temperature operation

When the ambient temperature thermistor RT65 reads 17°C or less, the operation mode moves to cool operation in low outside temperature from normal cool operation.

Each outdoor actuator (compressor/ fan/ LEV) is operated in the exclusive control, which is different from one of normal cool operation.

Especially fan motor doesn't operates continuously to maintain sufficient cooling capacity.

(1) Outdoor fan control

Outdoor unit (compressor) operates with outdoor fan OFF basically.

But any of following conditions is satisfied, the outdoor fan turns ON for about 5 seconds.

- a). the defrost thermistor RT61 reads 50°C or more.
- b). the fin temperature thermistor RT64 reads 60°C or more.

(2) LEV (expansion valve) control

In normal cool operation the opening degree of expansion valve is corrected according to the discharge temperature (RT62). But in this mode it is fixed to the value corresponding to the operation frequency of compressor.

(3) Dew drop prevention

When the ambient temperature thermistor RT65 reads -13°C or less, as coil frost or dew drop from indoor unit may occur, the compressor turns OFF with the outdoor fan ON for prevention of them.

NOTE: This control can be released by cut of the jumper line JG on the outdoor inverter P.C. board.

Be sure to cut it since user accepts that maker can't be responsible for coil frost or dew drop from indoor unit.

(4) Outside temperature detecting control

In this mode to detect the exact outside temperature the compressor turns OFF with the outdoor fan ON for 3 minutes once 1 hour.

4-1-2. DRY mode of "I FEEL CONTROL"

The system for dry operation uses the same refrigerant circuit as the cooling circuit.
 The compressor and the indoor fan are controlled by the room temperature.
 By such controls, indoor flow amounts will be reduced in order to lower humidity without much room temperature decrease.

1. Thermostat control

Thermostat is ON or OFF by difference between room temperature and set temperature.

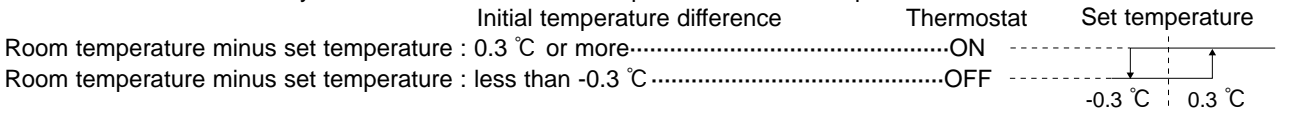

2. Indoor fan speed control

Indoor fan operates at the set speed by FAN SPEED CONTROL button.
 When thermostat OFF (compressor OFF) fan speed becomes Very Low.

3. The operation of the compressor and indoor fan/ outdoor fan

Compressor operates by temperature control and time control.

- ① Set temperature is controlled to fall 2°C from initial room temperature.
- ② Operational frequency of compressor during operation is fixed to 30Hz.

4. Coil frost prevention

Coil frost prevention is as same as COOL mode of "I FEEL CONTROL". (4-1-1.3.)
 The indoor fan maintains the actual speed of the moment. However, when coil frost prevention works while the compressor is not operating (= indoor fan speed Very Low), it's speed becomes the set speed.

5. Low outside temperature operation

Low outside temperature operation is as same as COOL mode of "I FEEL CONTROL". (4-1-1.4.)

4-1-3. HEAT mode of "I FEEL CONTROL"

1. Thermostat control

Thermostat is ON or OFF by difference between room temperature and set temperature.

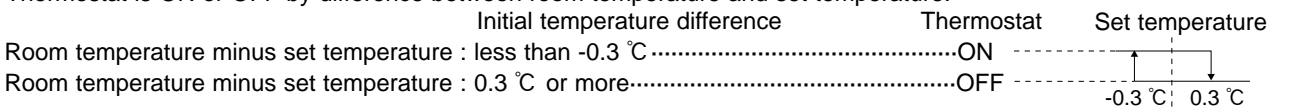

2. Indoor fan speed control

(1) Indoor fan operates at the set speed by FAN SPEED CONTROL button.
 In Auto the fan speed is as follows.

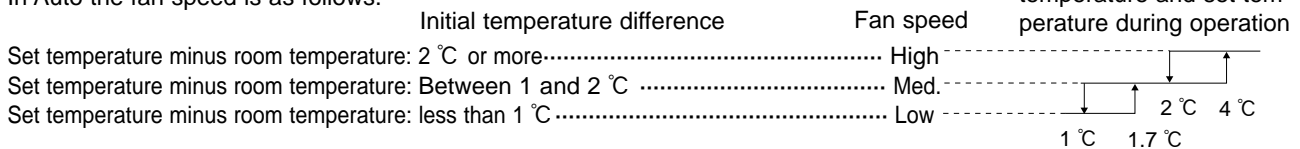

(2) Cold air prevention control

- ① When the compressor is not operating,
 - (I) if the temperature of indoor coil thermistor RT12 is 0°C or less, the fan stops.
 - (II) if the temperature of indoor coil thermistor RT12 is more than 0°C, the fan operates at Very Low.
- ② When the compressor is operating,
 - (I) if the temperature of RT12 is 40°C or more, the fan operates at set speed.
 - (II) if the temperature of RT12 is less than 40°C and
 - (i) if heating operation starts after defrosting, the fan stops.
 - (ii) if the temperature of room temperature thermistor RT11 is 15°C or less, the fan stops.
 - (iii) if the temperature of room temperature thermistor RT11 is more than 15°C, the fan operates at Very Low.

NOTE : When 3 minutes have passed since the compressor started operation, this control is released regardless of the temperature of RT12.

(3) Warm air control

When the following conditions of a) ~ b) are satisfied, warm air control works.

- a) when cold air prevention has been released after the compressor started operation
- b) when defrosting has been finished

When warm air control works, the fan speed changes from Low as follows to blow out warm air gradually.

When every 2 minutes have passed

- (I) if the temperature of RT12 is 22°C or more, the indoor fan speed is up by 1 step.
- (II) if the temperature of RT12 is 18°C to 22°C, the indoor fan speed is continued with the present speed.
- (III) if the temperature of RT12 is less than 18°C, the indoor fan speed is down by 1 step.

Gradation of fan speed in initial (example)

<Time condition>	<Indoor fan speed>
less than 2 minutes-----	Low
2 minutes to 4 minutes-----	Med.
more than 4 minutes-----	High

The upper limit of the fan speed in MANUAL is the set speed.

The upper limit of the fan speed in AUTO is the speed decided by indoor fan speed control.

When the temperature of RT12 has been 37°C or more, or when the set speed has been changed, this control is released and the fan speed is the set speed.

(4) Flow soft control

When the thermostat (compressor) is off, the indoor fan operates as follows.

Compressor	Fan
OFF	Very Low
ON	Set speed

NOTE : When the thermostat(compressor) turns ON, the fan will operate at set speed. But until cold air prevention and warm air control is released, the fan speed follow them.

3. High pressure protection

In HEAT operation the indoor coil thermistor detects the temperature of the indoor heat exchanger. The compressor operational frequency is controlled to prevent the condensing pressure from increasing excessively.

4. Overload starting

When the room temperature thermistor RT11 reads 18°C or more, the compressor runs with its maximum frequency regulated for 10 minutes after the start-up.

5. Defrosting

(1) Starting conditions of defrosting

When the following conditions a) ~ c) are satisfied, the defrosting starts.

- a) The defrost thermistor reads -3°C or less.
- b) The cumulative operation time of the compressor has reached any of the set values* (40, 45, 55, 65, 75, 85, 95, 105, 115, 125 minutes).
- c) More than 5 minutes have passed since the start-up of the compressor.

* Set value of compressor operation time(hereinafter referred to as defrost interval)

This is decided by the temperature of defrost thermistor and ambient temperature thermistor, the previous defrosting time. For example, the first defrost interval is 40 minutes long, and the second is 45 minutes long. The third and subsequent intervals are set to be longer, and less frequent, depending on defrosting time.

The third and subsequent defrost intervals follow any of the three patterns ...5 or 10 to 20 minutes longer, the same, or 5 or 10 to 20 minutes shorter compared with the previous defrost interval ... with the longest 125 minutes and the shortest 40 minutes.

(2) Releasing conditions of defrosting

Defrosting is released when any of the following conditions is satisfied:

- a) The defrost thermistor continues to read 5°C or more for 10 seconds.
- b) Defrosting time has exceeded 10 minutes.
- c) Any other mode than HEAT mode is set during defrosting.



Time chart of defrosting in HEAT mode (reverse type)

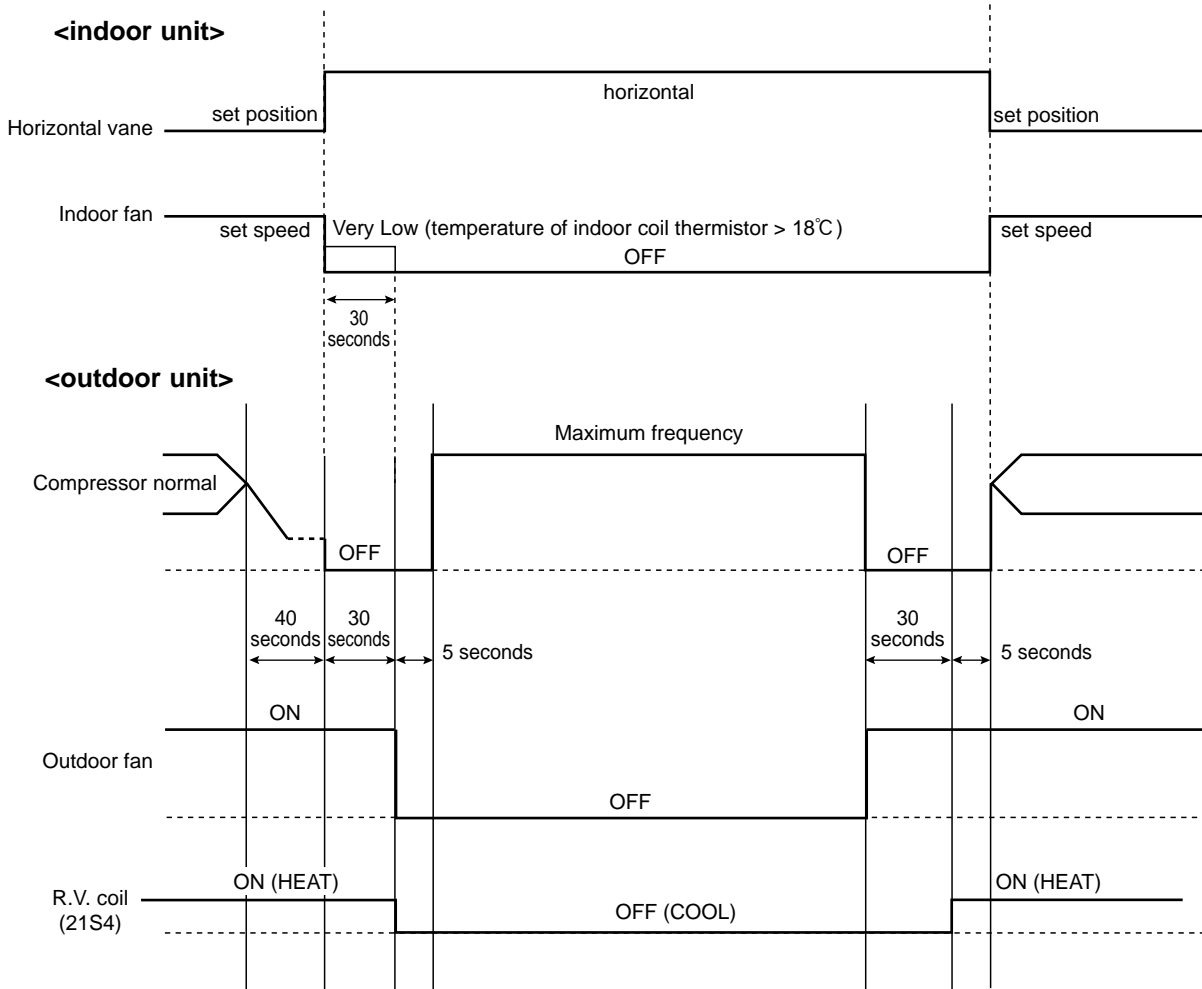

4-2. AUTO CHANGE OVER ... AUTO MODE OPERATION

Once desired temperature is set, unit operation is switched automatically between COOL and HEAT operation.

1. Mode selection

(1) Initial mode

At first indoor unit operates only indoor fan with outdoor unit OFF for 3 minutes to detect present room temperature. Following the conditions below, operation mode is selected.

- ① If the room temperature thermistor RT11 reads more than set temperature, COOL mode is selected.
- ② If the room temperature thermistor RT11 reads set temperature or less, HEAT mode is selected.

(2) Mode change

In case of the following conditions the operation mode is changed.

- ① COOL mode changes to HEAT mode when 15 minutes have passed with the room temperature 2 degrees below the set temperature.
- ② HEAT mode changes to COOL mode when 15 minutes have passed with the room temperature 2 degrees above the set temperature.

In the other cases than the above conditions, the present operation mode is continued.

NOTE1: Mode selection is performed when multi standby (refer to NOTE2) is released and the unit starts operation with ON-timer.

NOTE2: If two or more indoor units are operating in multi system, there might be a case that the indoor unit, which is operating in AUTO (□), cannot change over the other operating mode (COOL ↔ HEAT) and becomes a state of standby.

(3) Indoor fan control/ Vane control

As the indoor fan speed and the horizontal vane position depend on the selected operation mode, when the operation mode changes over, they change to the exclusive ones.

4-3. COOL (❄) OPERATION

- (1) Press OPERATE/STOP(ON/OFF) button.
OPERATION INDICATOR lamp of the indoor unit turns on with a beep tone.
- (2) Select COOL mode with OPERATION SELECT button.
- (3) Press TEMPERATURE buttons (TOO WARM or TOO COOL button) to select the desired temperature.
The setting range is 16 ~ 31°C

1. Thermostat control

Thermostat control is as same as COOL mode of "I FEEL CONTROL".(4-1-1.1.)

2. Indoor fan speed control

Indoor fan speed control is as same as COOL mode of "I FEEL CONTROL".(4-1-1.2.)

3. Coil frost prevention

Coil frost prevention is as same as COOL mode of "I FEEL CONTROL".(4-1-1.3.)

4. Low outside temperature operation

Low outside temperature operation is as same as COOL mode of "I FEEL CONTROL".(4-1-1.4.)

4-4. DRY (☁) OPERATION

- (1) Press OPERATE/STOP(ON/OFF) button.
OPERATION INDICATOR lamp of the indoor unit turns on with a beep tone.
- (2) Select DRY mode with OPERATION SELECT button.
- (3) The microprocessor reads the room temperature and determines the set temperature. Set temperature is as shown on the right chart.
- (4) DRY operation will not function when the room temperature is 13°C or below.

1. Thermostat control

Thermostat control is as same as DRY mode of "I FEEL CONTROL".(4-1-2.1.)

2. Indoor fan speed control

Indoor fan speed control is as same as DRY mode of "I FEEL CONTROL".(4-1-2.2.)

3. The operation of the compressor and indoor/outdoor fan

The operation of the compressor and indoor/outdoor fan is as same as DRY mode of "I FEEL CONTROL".(4-1-2.3.)

4. Coil frost prevention

Coil frost prevention is as same as DRY mode of "I FEEL CONTROL".(4-1-2.4.)

5. Low outside temperature operation

Low outside temperature operation is as same as DRY mode of "I FEEL CONTROL".(4-1-2.5.)

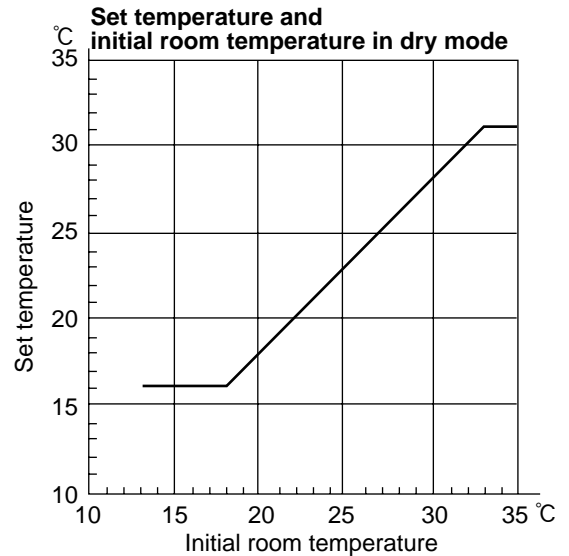

4-5. HEAT (☀) OPERATION

- (1) Press OPERATE/STOP(ON/OFF) button.
OPERATION INDICATOR lamp of the indoor unit turns on with a beep tone.
- (2) Select HEAT mode with OPERATION SELECT button.
- (3) Press TEMPERATURE buttons (TOO WARM or TOO COOL button) to select the desired temperature.
The setting range is 16 ~ 31°C.

1. Thermostat control

Thermostat control is as same as HEAT mode of "I FEEL CONTROL".(4-1-3.1.)

2. Indoor fan speed control

Indoor fan speed control is as same as HEAT mode of "I FEEL CONTROL".(4-1-3.2.)

3. High pressure protection

High pressure protection is as same as HEAT mode of "I FEEL CONTROL".(4-1-3.3.)

4. Overload starting

Overload starting is as same as HEAT mode of "I FEEL CONTROL".(4-1-3.4.)

5. Defrosting

Defrosting is as same as HEAT mode of "I FEEL CONTROL".(4-1-3.5.)

4-6. INDOOR FAN MOTOR CONTROL

1. Rotational frequency feedback control

The indoor fan motor is equipped with a rotational frequency sensor, and outputs signal to the microprocessor to feedback the rotational frequency. Comparing the current rotational frequency with the target rotational frequency (High, Med., Low) the microprocessor controls SR141 and adjusts fan motor electric current to make the current rotational frequency close to the target rotational frequency. With this control, when the fan speed is switched, the rotational frequency changes smoothly.

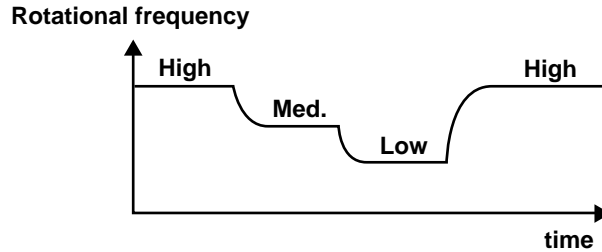

2. Fan motor lock-up protection

When the rotational frequency feedback signal is not output for 12 seconds, (or when the microprocessor cannot detect the signal for 12 seconds) the fan motor is regarded locked-up. Then the electric current to the fan motor is shut off. 3 minutes later, the electric current is applied to the fan motor again. During the fan motor lock-up, the OPERATION INDICATOR lamp flashes on and off to show the fan motor abnormality.

4-7. AUTO VANE OPERATION

(1) Vane motor drive

These models are equipped with a stepping motor for the horizontal vane. The rotating direction, speed, and angle of the motor are controlled by pulse signals (approx. 12V) transmitted from indoor microprocessor.

(2) The horizontal vane angle and mode change as follows by pressing the VANE CONTROL button.

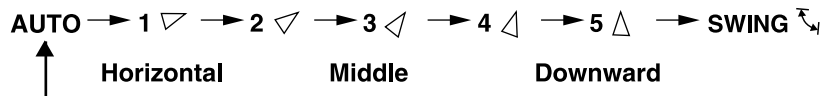

(3) Positioning

The vane presses the vane stopper once to confirm the standard position and then moves to the set angle. Confirming of standard position is performed in case of follows.

- When the power supply turns ON.
- When the operation starts or finishes (including timer operation).
- When the test run starts.
- When the vane control is changed AUTO to MANUAL (except SWING).
- When SWING is finished (including ECONO COOL).
- When multi-standby starts or finishes.

(4) VANE AUTO (@) mode

The microprocessor automatically determines the vane angle and operation to make the optimum room temperature distribution.

COOL and DRY operation

Vane angle is fixed to Angle 1.

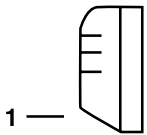

HEAT operation

Vane angle is fixed to Angle 4.

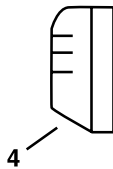

(5) STOP (operation OFF) and ON-TIMER standby

When the following cases occur, the horizontal vane returns to the closed position.

- When OPERATE/STOP (ON/OFF) button is pressed (POWER OFF).
- When the operation is stopped by the emergency operation.
- When ON-TIMER is ON standby.

(6) Dew prevention

During COOL or DRY operation with the vane angle at Angle 4 or 5 when the compressor cumulative operation time exceeds 1 hour, the vane angle automatically changes to Angle 1 for dew prevention.

(7) SWING MODE ()

By selecting SWING mode with VANE CONTROL button, the horizontal vane swings vertically. The remote controller displays “  ”. SWING mode is cancelled when VANE CONTROL button is pressed once again.

(8) Cold air prevention in HEAT operation.

When any of the following conditions occurs in HEAT operation, the vane angle changes to Angle 1 automatically to prevent cold air blowing on users.

- ① Compressor is not operating.
- ② Defrosting is performed.
- ③ Indoor coil thermistor RT12 reads 18°C or below.
- ④ Indoor coil thermistor RT12 temperature is raising from 18°C or below, but it does not exceed 38°C.

Indoor coil thermistor RT12 temperature

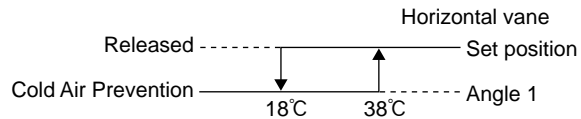

NOTE1: If the temperature of RT12 reads from 18°C to 38°C at the air conditioner starting, this control works.

NOTE2: When 2 or more indoor units are operated with multi outdoor unit, even if any indoor unit turns thermostat off, this control doesn't work in the indoor unit.

(9) ECONO COOL () operation (ECONOMical operation)

When ECONO COOL button is pressed in COOL mode, set temperature is automatically set 2°C higher.

Also the horizontal vane swings in various cycle according to the temperature of indoor heat exchanger(RT12).

SWING operation makes you feel cooler than set temperature. So, even though the set temperature is higher, the air conditioner can keep comfort. As a result, energy can be saved.

ECONO COOL operation is cancelled when ECONO COOL button is pressed once again or VANE CONTROL button is pressed or change to other operation mode.

NOTE : ECONO COOL operation does not work in COOL mode of “I FEEL CONTROL”.

<SWING operation>

In swing operation of ECONO COOL operation mode, the initial air flow direction is adjusted to “Horizontal”.

According to the temperature of indoor coil thermistor RT12 at starting of this operation, next downward blow time is decided. Then when the downward blow has been finished, next horizontal blow time is decided.

For initial 10 minutes the swing operation is performed in table G~H for quick cooling.

Also, after 10 minutes when the difference of set temperature and room temperature is more than 2°C, the swing operation is performed in table D~H for more cooling.

The air conditioner repeats the swing operation in various cycle as follows.

	Temperature of indoor coil thermistor RT12	Downward blow time (second)	Horizontal blow time (second)
A	15°C or less	2	23
B	15°C to 17°C	5	20
C	17°C to 18°C	8	17
D	18°C to 20°C	11	14
E	20°C to 21°C	14	11
F	21°C to 22°C	17	8
G	22°C to 24°C	20	5
H	more than 24°C	23	2

4-8. TIMER OPERATION

1. How to set the timer

(1) Press OPERATE/STOP(ON/OFF) button to start the air conditioner.

(2) Check that the current time is set correctly.



NOTE : Timer operation will not work without setting the current time. Initially “AM0:00” blinks at the current time display of TIME MONITOR, so set the current time correctly with CLOCK SET button.

(3) Press ON / OFF TIMER buttons to select the operation.

“ON-TIMER” button ... AUTO START operation (ON timer)

“OFF-TIMER” button... AUTO STOP operation (OFF timer)

(4) Press HR. and MIN. button to set the timer. Time setting is 10-minute units.

HR. and MIN. button will work when “  → | ” or “  → ○ ” mark is flashing.

These marks disappear in 1 minute.

After setting the ON timer, check that OPERATION INDICATOR lamp of the indoor unit lights.

NOTE1 : Be sure to place the remote controller at the position where its signal can reach the air conditioner even during TIMER operation, or the set time may deviate within the range of about 10 minutes.

NOTE2 : Reset the timer in the following cases, or the set time may deviate and other malfunctions may occur.

- A power failure occurs.
- The circuit breaker functions.

2. Cancel

TIMER setting can be cancelled with ON / OFF TIMER buttons.

To cancel ON timer, press "ON-TIMER" button.

To cancel OFF timer, press "OFF-TIMER" button.

TIMER is cancelled and the display of set time disappears.

PROGRAM TIMER

- OFF timer and ON timer can be used in combination.
- "↑" and "↓" display shows the order of OFF timer and ON timer operation.

(Example 1) The current time is 8:00 PM.
The unit turns off at 11:00 PM, and on at 6:00 AM.

(Example 2) The current time is 11:00 AM.
The unit turns on at 5:00 PM, and off at 9:00 PM.

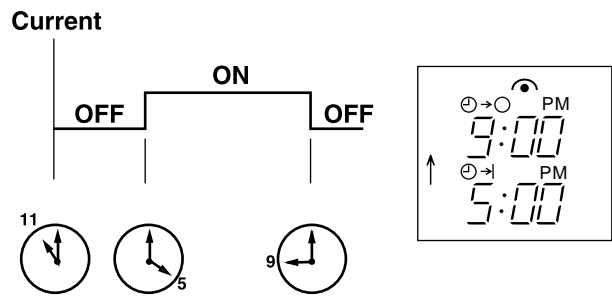
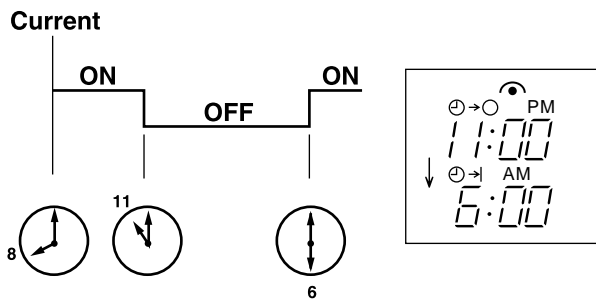

NOTE : TIMER setting will be cancelled by power failure or breaker functioning.

4-9. EMERGENCY / TEST OPERATION

In case of test run operation or emergency operation, use EMERGENCY OPERATION switch on the front of the indoor unit. Emergency operation is available when the remote controller is missing, has failed or the batteries of remote controller run down. The unit will start and OPERATION INDICATOR lamp will light.

The first 30 minutes of operation is the test run operation. This operation is for servicing. The indoor fan speed runs at High speed and the system is in continuous operation. (The thermostat is ON.)

After 30 minutes of test run operation, the system shifts to EMERGENCY COOL / HEAT MODE with a set temperature of 24°C.

The fan speed shifts to Med. speed.

The coil frost prevention works even in emergency operation, and defrosting too.

In the test run or emergency operation, the horizontal vane operates in VANE AUTO (@) mode.

Emergency operation continues until EMERGENCY OPERATION switch is pressed once or twice or the unit receives any signal from the remote controller. In case of latter, normal operation will start.

NOTE : Do not press EMERGENCY OPERATION switch during normal operation.

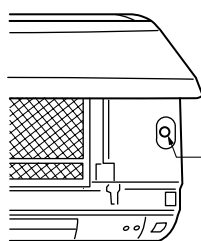

EMERGENCY OPERATION switch

• The following indication applies regardless of the shape of lamp.

OPERATION INDICATOR lamp

- Press once <Cool> Lighted
- Press again <Heat> Not Lighted
- Press once again <Stop>

4-10. INVERTER SYSTEM CONTROL

4-10-1. Inverter main power supply circuit

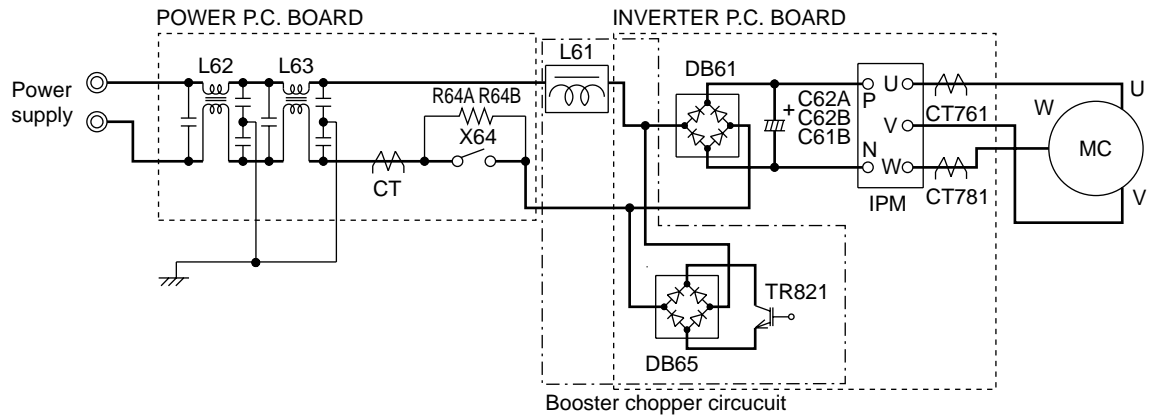

Function of main parts

SYMBOL	NAME	FUNCTION	
IPM	INTELLIGENT POWER MODULE	It supplies three-phase AC power to compressor.	
C62A/C62B/C61B	SMOOTHING CAPACITOR	It stabilizes the DC voltage.	
CT761/CT781	CURRENT TRANSFORMER	It measures the current of the compressor motor.	
CT	CURRENT TRANSFORMER	It measures the value of current which is supplied to the main power supply circuit.	
DB61	DIODE MODULE	It converts the AC voltage to DC voltage.	
R64A, R64B	CURRENT-LIMITING RESISTOR	It absorbs the rush current not to run into the main power supply circuit when the electricity turns ON.	
X64	RELAY	It short-circuits the resistance which restricts rush current during the normal operation after the compressor startup.	
DB65	DIODE MODULE	Booster chopper circuit	It improves power factor. It rectifies AC and controls its voltage.
TR821	SWITCHING POWER TRANSISTOR		
L61	REACTOR		

4-10-2. Outline of main power supply circuit

1. At the start of operation

Main power supply circuit is formed when X64 (Relay) is turned ON at compressor startup.

To prevent rush current from running into the circuit when power supply is turned ON, R64A and R64B (Current-limiting resistor) are placed in sub circuit.

2. At normal operation

- ① When AC runs into POWER P.C. board, its external noise is eliminated in the noise filter circuit.
- ② After noise is eliminated from AC, it is rectified to DC by DB61 (Diode module).
- ③ DC voltage, to which AC has been rectified by process ②, is stabilized by C62A, C62B and C61B (Smoothing capacitor) and supplied to IPM (INTELLIGENT POWER MODULE).
- ④ DC voltage, which has been stabilized in process ③, is converted to three-phase AC by IPM and supplied to compressor.
- ⑤ CT761 and CT781 (Current Transformer), which are placed in the power supply circuit to compressor, are used to measure the value of phase current and locate the polar direction of rotor with algorithm. PWM (Pulse width modulation) controls impressed voltage and frequency with those information.

3. Purpose of PAM adoption

PAM : Pulse Amplitude Modulation

PAM has been adopted for the efficiency improvement and the adaptation to IEC harmonic current emission standard.

Outline of simple partial switching method

In conventional inverter models, diode module rectifies AC voltage to DC voltage, smoothing capacitor makes its DC waveform smooth, and IPM converts its DC voltage to imitated AC voltage again in order to drive the compressor motor.

However, it has been difficult to meet IEC harmonic current emission standard by above circuit because harmonic gets generated in the input current waveform and power factor gets down. The simple partial switching method with PAM, which has been adopted this time, places and utilizes the booster chopper circuit (L61, DB65 and TR821) before rectifying AC voltage in the general passive-method converter circuit. As harmonic gets suppressed and the peak of waveform gets lower by adding booster chopper circuit as mentioned above and by synchronizing the timing of one-time switching with the zero-cross point of waveform, the input current waveform can be improved and the requirement of IEC harmonic current emission standard can be satisfied. Since the switching times is just once by synchronizing with the zero cross point, this simple partial switching method has the feature of lower energy loss compared to active filter method. In addition, output and efficiency is enhanced by combining with vector-controlled inverter in order to boost the voltage of power supplied to IPM.

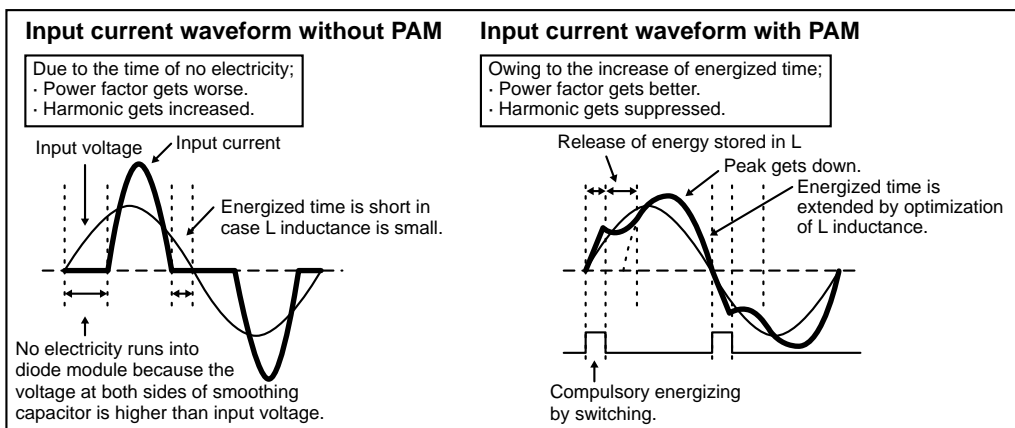

4. Intelligent power module

IPM consists of the following components

- IGBT (x6) : Converts DC waveform to three-phase AC waveform and outputs it.
- Drive Circuit : Drives transistors.
- Protection circuit : Protects transistors from overcurrent.

Since the above components are all integrated in IPM, IPM has a merit to make the control circuit simplify and miniaturize.

5. Smoothing capacitor

C62A, C62B and C61B stabilize the DC voltage and supply it to IPM.

6. Elimination of electrical noise

Noise filter circuit, which is formed by *CMC COILS capacitors placed on the POWER P.C. board, eliminates electrical noise of AC power that is supplied to main power supply circuit. And this circuit prevents the electrical noise generated in the inverter circuit from leaking out.

*CMC COILS; Common mode choke coils

4-10-3. Sine wave control

In these air conditioners, compressor equips brushless DC motor which doesn't have Hall element.

In short, the motor is sensorless. However, it's necessary to locate the polar direction of rotor in order to drive brushless DC motor efficiently. The general detection method of the polar direction for such a DC motor is to locate it from the voltage induced by unenergized stator.

Therefore, It is necessary to have a certain period of time in which the stator is being unenergized for the rotor position detection when the voltage of supplied power is impressed.

So the motor has been driven by square wave control (the conventional motor drive system) which energizes the motor only when the range of electrical angle is within 120° because it is forced to be unenergized within 30° at start & end of one heap in one waveform cycle (180°) when the voltage is impressed.

However, torque pulsation occurs at rotation in this method when the current-carrying phases are switched over to other phases in sequence. Therefore, sine wave control system is adopted for these air conditioners because it can make the phase-to-phase current waveform smoother (sine wave) in order to drive the motor more efficiently and smoothly.

4-10-4. Characteristics of sine wave control in case of brushless DC motor

- Although ordinary three-phase induction motor requires energy to excite the magnetic field of rotor, brushless DC motor doesn't need it. So, higher efficiency and torque are provided.
- This control provides the most efficient waveform corresponding to the rotation times of compressor motor.
- The rotation can be set to higher compared to the conventional motor drive system. So, the time in which air conditioner can be operated with energy saved is longer than conventional models. This can save annual electric consumption.
- Compared to square wave control, the torque pulsation is reduced at rotation so that the motor operates more quietly.
- Since response and efficiency of motor are enhanced in sine wave control, finer adjustment can be provided.

	DC Motor	AC Motor
Rotor	Permanent magnet is embedded.	Excited by magnetic field of stator
Rotor Position Signal	Necessary	Unnecessary

* In brushless DC motor, permanent magnet is embedded in the rotor. Therefore, it doesn't require energy to excite the rotor like AC motor does. However, it's necessary to control the frequency of three-phase AC current supplied to the stator according to the polar direction of magnet embedded in the rotor so as to drive the motor efficiently. Controlling three-phase AC current frequency also means controlling the timing to switch the polarity of stator. Therefore, the polar direction of rotor needs to be detected.

4-10-5. Control Method of Rotation Times

Sine wave control makes the current transformers conduct real time detection of the value of the current running into the motor, locates the rotor position from the detected value, and decides if voltage should be impressed and if frequency should be changed.

Compared to the conventional control and rotor position detection method, sine wave control can provide finer adjustment of the voltage of supplied power. The value of the current running into the motor is determined by each motor characteristic.

4-11. OPERATIONAL FREQUENCY CONTROL OF OUTDOOR UNIT

1. Outline

The operational frequency is as following:

First, the target operational frequency is set based on the difference between the room temperature and the set temperature.

Second, the target operational frequency is regulated by discharge temperature protection, high pressure protection, electric current protection and overload protection and also by the maximum/minimum frequency.

2. Maximum/minimum frequency in each operation mode.

Applied model	COOL			HEAT			DRY
	Minimum frequency	Rated frequency	Maximum frequency	Minimum frequency	Rated frequency	Maximum frequency	
MUZ-CA25VB	30	57	87	40	75	98	30
MUZ-CA35VB	30	69	84	30	76	98	30

* The operation frequency in COOL mode is restricted the upper limit frequency after 1 hour as shown below for dew prevention.

It is rated frequency or less.

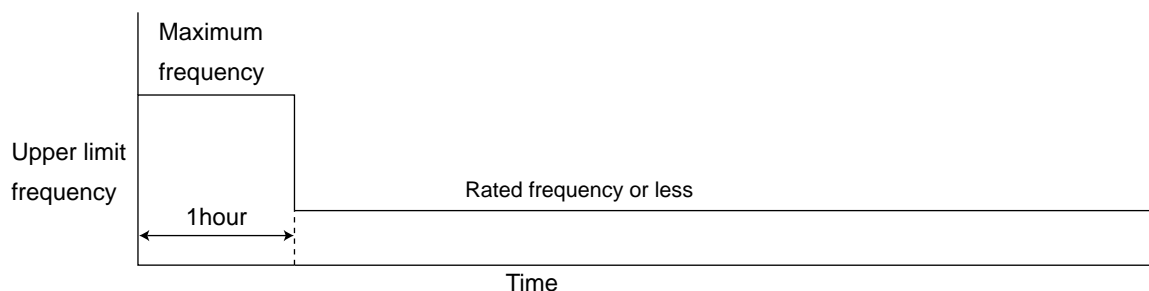

4-12. EXPANSION VALVE CONTROL (LEV CONTROL)

(1) Outline of LEV control

The LEV basic control is comprised of setting LEV opening degree to the standard opening degrees set for each operational frequency of the compressor. However, when any change in indoor/outdoor temperatures or other factors cause air conditioning load fluctuation, the LEV control also works to correct LEV opening degree based on discharge temperature (Shell temperature) of the compressor, developing the unit's performance.

standard specification	Control range	from minimum 33 pulse to maximum 500 pulse.
	Actuating speed	LEV opens 40 pulse/second and close 90 pulse/second
	Opening degree adjustment	LEV opening degree is always adjusted in opening direction. (When reducing the opening degree, LEV is once over-closed, and then adjusted to the proper degree by opening.
general operation	Unit OFF	LEV remains at maximum opening degree (reaches maximum opening degree approximate in 15 minutes after compressor stops)
	Remote controller ON	LEV is positioned. (first full-closed at zero pulse and then positioned.)
	During 2 to 13 minutes after compressor starts	LEV is fixed to standard opening degree according to operational frequency of compressor.
	More than 13 minutes have passed since compressor start-up	LEV opening degree is corrected to get target discharge temperature of compressor. (For discharge temperature lower than target temperature, LEV is corrected in closing direction.) (For discharge temperature higher than target temperature, LEV is corrected in opening direction.) ※It may take more than 30 minutes to reach target temperature, depending on operating conditions.
	Thermostat OFF	LEV is adjusted to exclusive opening degree for thermostat OFF.
	Thermostat ON	LEV is controlled in the same way as that after the compressor has started up.
	Defrosting in HEAT mode	LEV is adjusted to open 500 pulse.

(2) Time chart

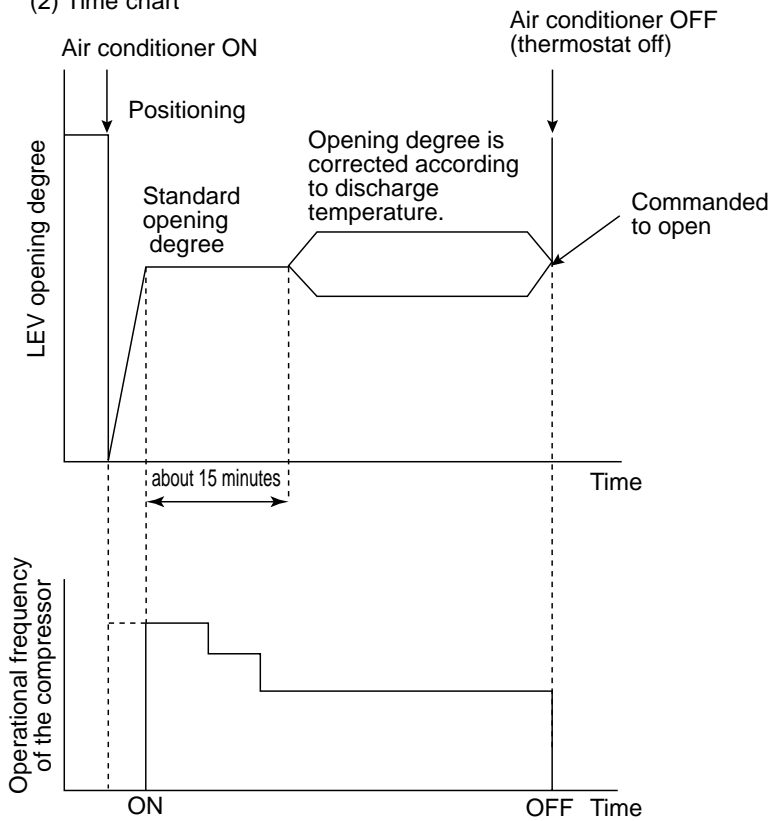

(3) Control data

(a) Reference value of target discharge temperature (COOL/HEAT °C)

Applied model	A	B	C	D	E	F
MUZ-CA25VB	50/46	54/53	60/58	64/63	67/68	67/72
MUZ-CA35VB	57/45	57/53	63/59	67/65	67/69	67/72

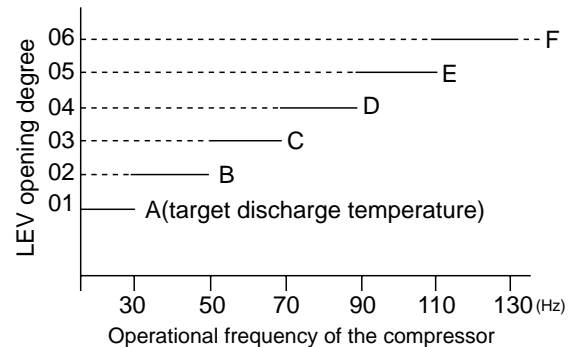

In COOL operation, the two indoor coil thermistors (one main and one sub) sense temperature ununiformity (super heat) at the heat exchanger, and when temperature difference have developed, the indoor coil thermistors adjust LEV opening degree to get approximate 10 degrees lower temperature than the target temperature in the table above, thus diminishing super heat.

(b) Reference value of LEV standard opening degree (COOL/ HEAT pulse)

Applied model	01	02	03	04	05	06
MUZ-CA25VB	110/80	120/120	130/160	220/190	280/200	280/200
MUZ-CA35VB	150/90	170/130	180/140	260/200	280/210	280/210

MSZ-FA25VA MUZ-FA25VA MUZ-FA25VAH
MSZ-FA35VA MUZ-FA35VA MUZ-FA35VAH

WIRELESS REMOTE CONTROLLER

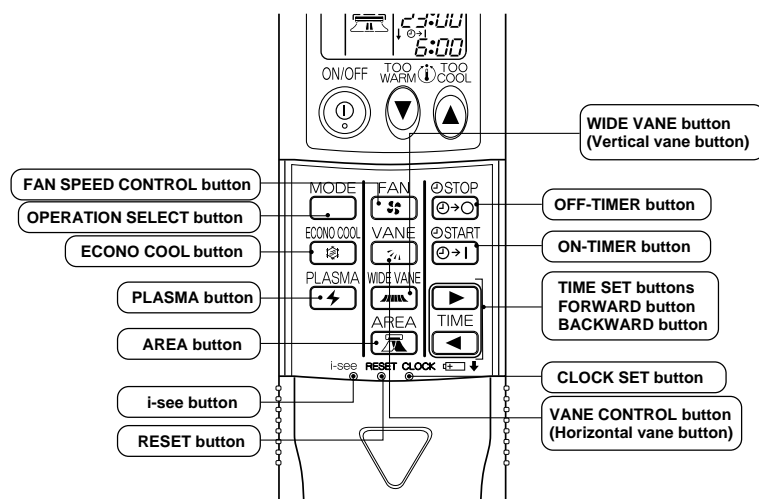
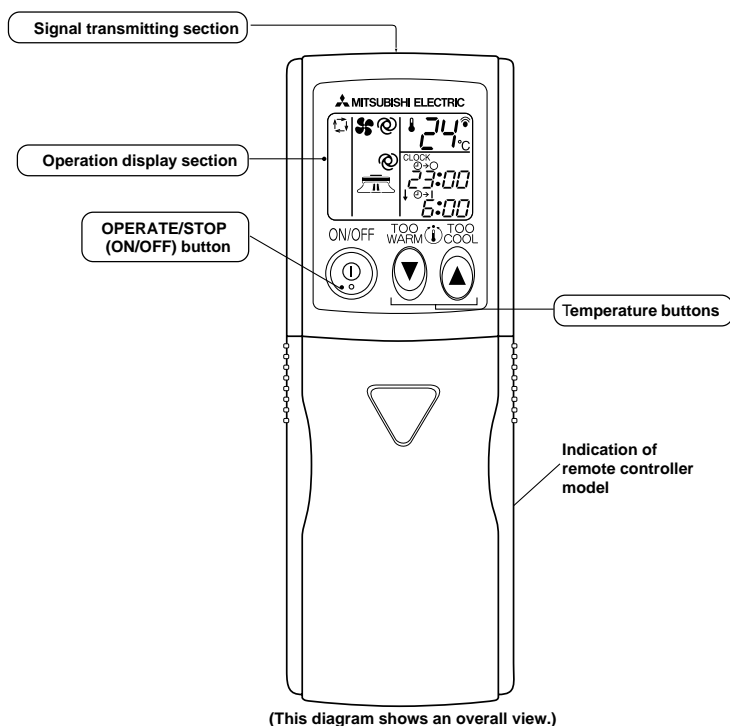

Once the operation mode is set, the same operation mode can be repeated by simply turning OPERATE/STOP (ON/OFF) button ON.

Indoor unit receives the signal with a beep tone.

When the system turns off, 3-minute time delay will operate to protect system from overload and compressor will not restart for 3 minutes.

5-1. COOL (❄) OPERATION

- (1) Press OPERATE/STOP(ON/OFF) button.
POWER lamp of the indoor unit turns on with a beep tone.
- (2) Select COOL mode with OPERATION SELECT button.
- (3) Press TEMPERATURE buttons (TOO WARM or TOO COOL button) to select the desired temperature.
The setting range is 16 ~ 31°C

1. Thermostat control

Thermostat is ON or OFF by difference between room temperature and set temperature

Initial temperature difference
 Room temperature minus set temperature : -1.0 °C or moreON
 Room temperature minus set temperature : less than -1.0 °COFF

Difference between room temperature and set temperature during operation.

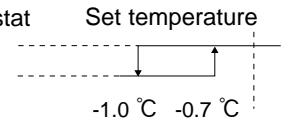

2. Indoor fan speed control

Indoor fan operates continuously at the set speed by FAN SPEED CONTROL button regardless of the thermostat's OFF-ON.
 In AUTO the fan speed is as follows.

Initial temperature difference
 Room temperature minus set temperature : 1.7 °C or moreHigh
 Room temperature minus set temperature : Between 1 and 1.7 °CMed.
 Room temperature minus set temperature : less than 1 °CLow

Difference between room temperature and set temperature during operation

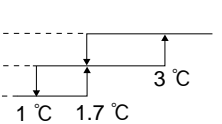

3. Coil frost prevention

Temperature control

When indoor coil thermistor detects following temperature for 90 seconds, operational frequency of compressor is controlled according to the following table.

Temperature of indoor coil thermistor	Operation frequency
10°C or more	Normal (variable)
8°C to 10°C	Raise 6 Hz
6°C to 8°C	Fixed
3°C to 6°C	Lower 3Hz
3°C or less	Lower 6Hz Compressor is turned OFF for 5 minutes when temperature of indoor coil thermistor continues 3°C or less for 5 minutes or more.

The indoor fan maintains the actual speed of the moment.

4. Low outside temperature operation

If the outside temperature falls to 18°C or less during operation in COOL mode, the unit enters the low outside temperature operation mode.

<Operation>

- (1) If the unit enters the low outside temperature operation mode, the outside fan rotation speed gets slow down.
- (2) Even when the unit is in the "thermostat-off" status under the low outside temperature operation mode, the outside fan rotation does not stop.
- (3) In this mode to detect the exact outside temperature the compressor turns OFF with the outdoor fan ON for 3 minutes once 1 hour; if the outside temperature rises over 18°C, the unit goes back to the normal COOL mode, and if the outside temperature is still 18°C or less, the unit stays in the low outside temperature operation mode.
- (4) Dew drop prevention

When the ambient temperature thermistor RT65 reads -12°C or less, as coil frost or dew drop from indoor unit may occur, the compressor turns OFF with the outdoor fan ON for prevention of them.

※Other protections work as well as in the normal COOL mode.

5-2. DRY (\triangle) OPERATION

- (1) Press OPERATE/STOP(ON/OFF) button.
POWER lamp of the indoor unit turns on with a beep tone.
- (2) Select DRY mode with OPERATION SELECT button.
- (3) The microprocessor reads the room temperature and determines the set temperature. Set temperature is as shown on the right chart.

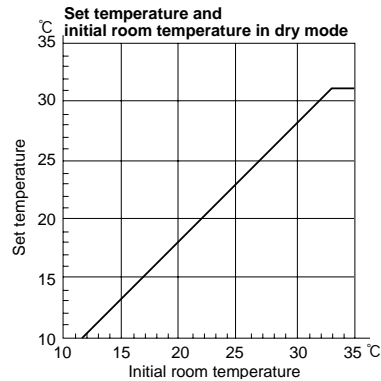

The system for dry operation uses the same refrigerant circuit as the cooling circuit. The compressor and the indoor fan are controlled by the room temperature.

By such controls, indoor flow amounts will be reduced in order to lower humidity without much room temperature decrease.

1. Thermostat control

Thermostat is ON or OFF by difference between room temperature and set temperature.

Difference between room temperature and set temperature during operation

Initial temperature difference	Thermostat	Set temperature
Room temperature minus set temperature : $-1.0\text{ }^{\circ}\text{C}$ or more	ON	
Room temperature minus set temperature : less than $-1.0\text{ }^{\circ}\text{C}$	OFF	

2. Indoor fan speed control

Indoor fan operates at the set speed by FAN SPEED CONTROL button. When thermostat OFF (compressor OFF) fan speed becomes Very Low. In AUTO the fan speed is as follows.

Difference between room temperature and set temperature during operation

Initial temperature difference	Fan speed	Set temperature
Room temperature minus set temperature : $1.7\text{ }^{\circ}\text{C}$ or more	High	
Room temperature minus set temperature : Between 1 and $1.7\text{ }^{\circ}\text{C}$	Med.	
Room temperature minus set temperature : less than $1\text{ }^{\circ}\text{C}$	Low	

3. Coil frost prevention

Coil frost prevention is as same as COOL mode. (5-1.3.) The indoor fan maintains the actual speed of the moment.

4. Low outside temperature operation

Low outside temperature operation is as same as COOL mode. (5-1.4.)

5-3. HEAT (\odot) OPERATION

- (1) Press OPERATE/STOP(ON/OFF) button.
POWER lamp of the indoor unit turns on with a beep tone.
- (2) Select HEAT mode with OPERATION SELECT button.
- (3) Press TEMPERATURE buttons (TOO WARM or TOO COOL button) to select the desired temperature.
The setting range is $16\text{ }^{\circ}\text{C}$ ~ $31\text{ }^{\circ}\text{C}$.

Difference between room temperature and set temperature during operation

1. Thermostat control

Thermostat is ON or OFF by difference between room temperature and set temperature.

Initial temperature difference	Thermostat	Set temperature
Room temperature minus set temperature : less than $2.0\text{ }^{\circ}\text{C}$	ON	
Room temperature minus set temperature : $2.0\text{ }^{\circ}\text{C}$ or more	OFF	

2. Indoor fan speed control

- (1) Indoor fan operates at the set speed by FAN SPEED CONTROL button. In Auto the fan speed is as follows.

Difference between room temperature and set temperature during operation

Initial temperature difference	Fan speed	Set temperature
Set temperature minus room temperature: $2\text{ }^{\circ}\text{C}$ or more	High	
Set temperature minus room temperature: Between 0.2 and $2\text{ }^{\circ}\text{C}$	Med.	
Set temperature minus room temperature: less than $0.2\text{ }^{\circ}\text{C}$	Low	

- (2) Cold air prevention control

- ① When the compressor is not operating,
 - (I) if the temperature of room temperature thermistor RT11 is less than $19\text{ }^{\circ}\text{C}$, the fan stops.
 - (II) if the temperature of room temperature thermistor RT11 is $19\text{ }^{\circ}\text{C}$ or more and
 - (i) if the temperature of RT12 is less than $0\text{ }^{\circ}\text{C}$, the fan stops.
 - (ii) if the temperature of RT12 is $0\text{ }^{\circ}\text{C}$ or more, the fan operates at Very Low.
- ② When the compressor is operating,
 - (I) if the temperature of RT12 is $40\text{ }^{\circ}\text{C}$ or more, the fan operates at set speed.
 - (II) if the temperature of RT12 is less than $40\text{ }^{\circ}\text{C}$ and
 - (i) if heating operation starts after defrosting, the fan stops.
 - (ii) if the temperature of room temperature thermistor RT11 is $19\text{ }^{\circ}\text{C}$ or less, the fan stops.
 - (iii) if the temperature of room temperature thermistor RT11 is more than $19\text{ }^{\circ}\text{C}$, the fan operates at Very Low.

NOTE : When 3 minutes have passed since the compressor started operation, this control is released regardless of the temperature of RT11 and RT12.

3. High pressure protection

In HEAT operation the indoor coil thermistor detects the temperature of the indoor heat exchanger. The compressor operational frequency is controlled to prevent the condensing pressure from increasing excessively.

4. Overload starting

When the room temperature thermistor RT11 reads 18°C or more, the compressor runs with its maximum frequency regulated for 10 minutes after the start-up.

5. Defrosting

(1) Starting conditions of defrosting

When the following conditions a) ~ c) are satisfied, the defrosting starts.

- The defrost thermistor reads -3°C or less.
- The cumulative operation time of the compressor has reached any of the set values* (30, 35, 40, 45, 55, 65, 75, 85, 95, 105, 115, 125, 150 minutes).
- More than 5 minutes have passed since the start-up of the compressor.

* Set value of compressor operation time(hereinafter referred to as defrost interval)

This is decided by the temperature of defrost thermistor and ambient temperature thermistor, the previous defrosting time. For example, the first defrost interval is 40 minutes long, and the second is 45 minutes long. The third and subsequent intervals are set to be longer, and less frequent, depending on defrosting time.

The third and subsequent defrost intervals follow any of the three patterns ...5 or 10 to 20 minutes longer, the same, or 5 or 10 to 20 minutes shorter compared with the previous defrost interval ... with the longest 150 minutes and the shortest 30 minutes.

(2) Releasing conditions of defrosting

Defrosting is released when any of the following conditions is satisfied:

- The defrost thermistor continues to read 5°C or more (MUZ-FA25VA) / 8°C or more (MUZ-FA25VAH) / 10°C or more (MUZ-FA35VA) / 13°C*¹ or 10°C*² or more (MUZ-FA35VAH) for 30 seconds.

*¹ 13°C (Serial No: ~6002550)

*² 10°C (Serial No: 6002551~)

- Defrosting time has exceeded 10 minutes.
- Any other mode than HEAT mode is set during defrosting.

6. Defrost heater (MUZ-FA25/ FA35VAH)

(1) Starting conditions

When all of the following conditions a) ~ d) are satisfied, defrost heater turns ON to prevent ice from foaming on the base of outdoor unit.

- HEAT mode is selected.
- The ambient temperature thermistor RT65 reads 5°C or less for 5 minutes continuously. (NOTE 1).
- The defrost thermistor RT61 reads -1°C or less for 5 minutes continuously.
- Outdoor fan motor is turned ON.

(2) Releasing conditions

When any of the following conditions is satisfied, defrost heater turns OFF.

- Any other mode than HEAT mode is selected. (NOTE 2).
- The ambient temperature thermistor RT65 reads 8°C or more for 5 minutes continuously. (NOTE 1).
- The defrost thermistor RT61 reads more than 15°C for 5 minutes continuously.
- Outdoor fan motor is turned OFF.

NOTE1 : Ambient temperature thermistor RT65.

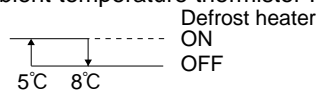

NOTE2 : During defrosting operation defrost heater continues to be ON.



Time chart of defrosting in HEAT mode (reverse type)

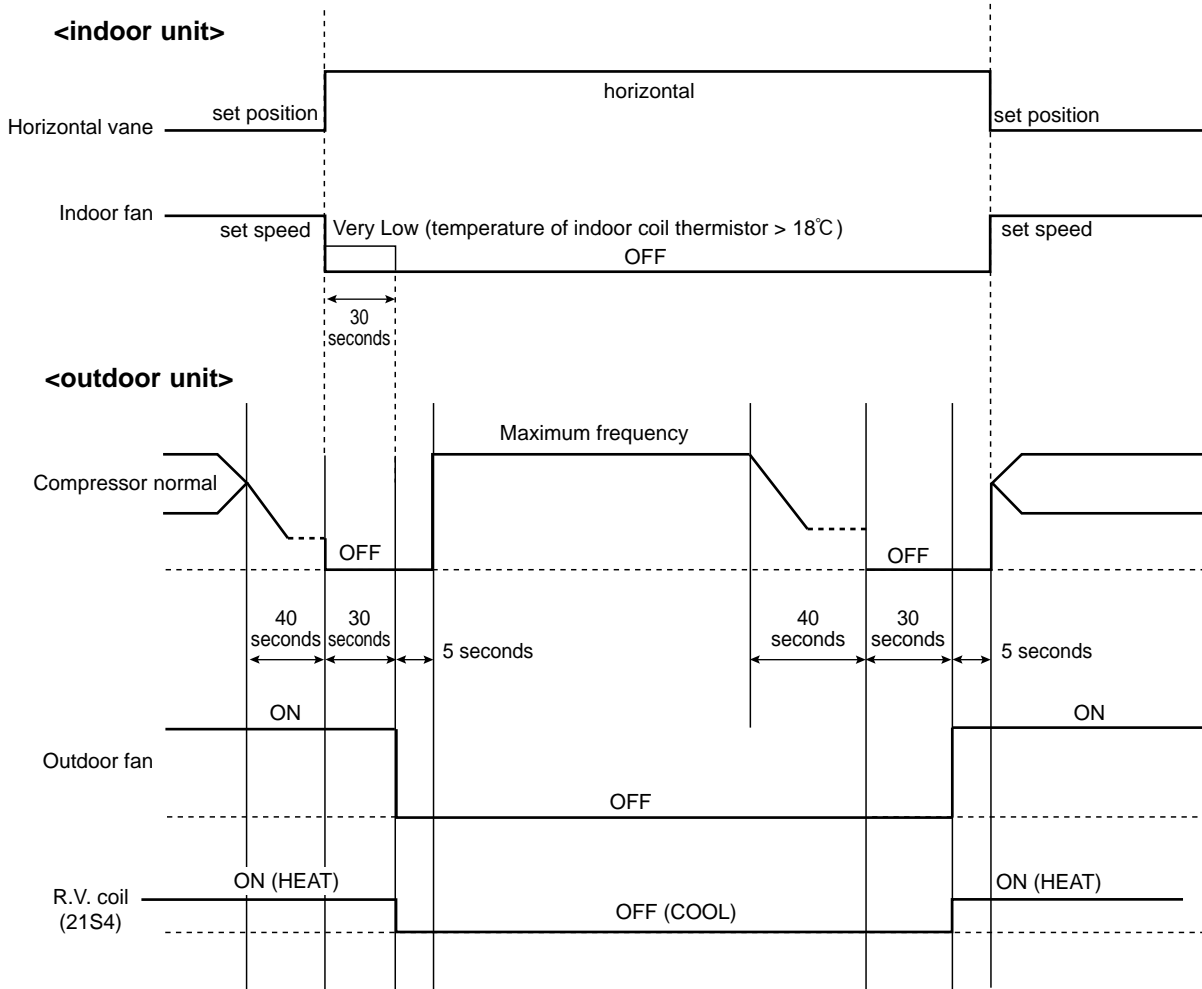

5-4. AUTO CHANGE OVER ... AUTO MODE OPERATION

Once desired temperature is set, unit operation is switched automatically between COOL and HEAT operation.

1. Mode selection

(1) Initial mode

At first indoor unit operates only indoor fan with outdoor unit OFF for 3 minutes to detect present room temperature. Following the conditions below, operation mode is selected.

- ① If the room temperature thermistor RT11 reads more than set temperature, COOL mode is selected.
- ② If the room temperature thermistor RT11 reads set temperature or less, HEAT mode is selected.

(2) Mode change

In case of the following conditions the operation mode is changed.

- ① COOL mode changes to HEAT mode when 15 minutes have passed with the room temperature 2 degrees below the set temperature.
- ② HEAT mode changes to COOL mode when 15 minutes have passed with the room temperature 2 degrees above the set temperature.

In the other cases than the above conditions, the present operation mode is continued.

NOTE1: Mode selection is performed when multi standby (refer to NOTE2) is released and the unit starts operation with ON-timer.

NOTE2: If two or more indoor units are operating in multi system, there might be a case that the indoor unit, which is operating in AUTO (□), cannot change over the other operating mode (COOL ↔ HEAT) and becomes a state of standby.

(3) Indoor fan control/ Vane control

As the indoor fan speed and the horizontal vane position depend on the selected operation mode, when the operation mode changes over, they change to the exclusive ones.

5-5. INDOOR FAN MOTOR CONTROL

(1) Rotational frequency feedback control

The indoor fan motor is equipped with a rotational frequency sensor, and outputs signal to the microprocessor to feedback the rotational frequency. Comparing the current rotational frequency with the target rotational frequency (Super High, High, Med., Low), the microprocessor adjusts fan motor electric current to make the current rotational frequency close to the target rotational frequency. With this control, when the fan speed is switched, the rotational frequency changes smoothly.



(2) Fan motor lock-up protection

When the rotational frequency feedback signal has not output for 12 seconds, (or when the microprocessor cannot detect the signal for 12 seconds) energizing to the fan motor is stopped. Then the microprocessor retries detection 3 times every 30 seconds. If the microprocessor still cannot detect the signal, the fan motor is regarded locked-up. When the fan motor lock-up, POWER lamp flashes on and off to show the fan motor abnormality.

5-6. OUTDOOR FAN MOTOR CONTROL

Fan speed is switched according to the compressor frequency.

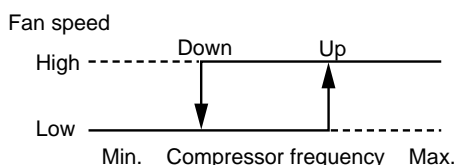

<Relation between compressor frequency and fan speed>

Mode	Fan speed	Compressor frequency	
		MUZ-FA25	MUZ-FA35
COOL	Up	54Hz	43Hz
	Down	41Hz	33Hz
HEAT	Up	54Hz	43Hz
	Down	41Hz	33Hz

5-7. AUTO VANE OPERATION

1. Horizontal vane

(1) Vane motor drive

These models are equipped with a stepping motor for the horizontal vane. The rotating direction, speed, and angle of the motor are controlled by pulse signals (approx. 12V) transmitted from indoor microprocessor.

(2) The horizontal vane angle and mode changes as follows by pressing VANE CONTROL button.

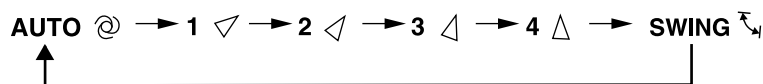

(3) Positioning

The vane is once pressed to the vane stopper to confirm the standard position and then moves to the set angle. Confirming of standard position is performed in case of follows.

(a) When the operation starts or finishes (including timer operation).

(b) When the test run starts.

(c) When multi-standby starts or finishes.

(4) VANE AUTO (⊙) mode

The microprocessor automatically determines the vane angle and operation to make the optimum room temperature distribution.

COOL and DRY operation

Vane angle is fixed to Horizontal position.



HEAT operation

Vane angle is fixed to Angle 4.

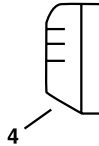

(5) STOP (operation OFF) and ON-TIMER standby

When the following cases occur, the horizontal vane returns to the closed position.

- (a) When OPERATE/STOP (ON/OFF) button is pressed (POWER OFF).
- (b) When the operation is stopped by the emergency operation.
- (c) When ON-TIMER is ON standby.

(6) Dew prevention

During COOL or DRY operation with the vane angle at Angle 2 ~ 4 when the compressor cumulative operation time exceeds 1 hour, the vane angle automatically changes to Angle 1 for dew prevention.

(7) SWING MODE (↕)

By selecting SWING mode with VANE CONTROL button, the horizontal vane swings vertically. The remote controller displays "↕". SWING mode is cancelled when VANE CONTROL button is pressed once again.

(8) Cold air prevention in HEAT operation.

When any of the following conditions occurs in HEAT operation, the vane angle changes to Horizontal position automatically to prevent cold air blowing on users.

- ① Compressor is not operating.
- ② Defrosting is performed.
- ③ Indoor coil thermistor RT12 reads 24°C or below.
- ④ Indoor coil thermistor RT12 temperature is raising from 24°C or below, but it does not exceed 39°C.
- ⑤ For about 3 minutes after compressor starts.

NOTE : When 2 or more indoor units are operated with multi outdoor unit, even if any indoor unit turns thermostat off, this control doesn't work in the indoor unit.

(9) To change the air flow direction not to blow directly onto your body.

To change the air flow direction	When to use this function?	COOL/DRY	HEAT
<p>Pressing and holding VANE CONTROL button for 2 seconds or more causes the horizontal vane to reverse and move to horizontal position.</p> <p>Horizontal position</p>	<p>Use this function if you don't want the air from the indoor unit to blow directly onto your body.</p> <ul style="list-style-type: none"> • Depending on the shape of the room, the air may blow directly onto your body. • Press VANE CONTROL button again to return the vane to the previously-set position. 	<p>The air conditioner starts the cooling or drying operation approx. 3 minutes after the vane has moved to the horizontal position.</p> <ul style="list-style-type: none"> • When VANE CONTROL button is pressed again, the vane returns to the previously-set position and the air conditioner starts the cooling or drying operation in approx. 3minutes. 	<p>The air conditioner starts heating operation approx. 3 minutes after the vane has moved to the horizontal position.</p> <ul style="list-style-type: none"> • Sometimes the area around your feet may not warm. To warm the area around the feet, set the horizontal vane to ⊙ (AUTO) or the downward-blowing position. • When VANE CONTROL button is pressed again, the vane returns to the previously-set position and the air conditioner starts the heating operation in approx. 3minutes.

NOTE:

- If you make the air flow not to blow directly onto your body by pressing VANE CONTROL button, the compressor stops for 3 minutes even during the operation of the air conditioner.
- The air conditioner operates with decreased air flow until the compressor turns on again.

(10) ECONO COOL () operation (ECONOMical operation)

When ECONO COOL button is pressed in COOL mode, set temperature is automatically set 2°C higher.

Also the horizontal vane swings in various cycle according to the temperature of indoor heat exchanger(RT12).

SWING operation makes you feel cooler than set temperature. So, even though the set temperature is higher, the air conditioner can keep comfort. As a result, energy can be saved.

ECONO COOL operation is cancelled when ECONO COOL button is pressed once again or VANE CONTROL button is pressed or change to other operation mode.

<SWING operation>

In swing operation of ECONO COOL operation mode, the initial air flow direction is adjusted to "Horizontal".

According to the temperature of indoor coil thermistor RT12 at starting of this operation, next downward blow time is decided. Then when the downward blow has been finished, next horizontal blow time is decided.

For initial 10 minutes the swing operation is performed in table G~H for quick cooling.

Also, after 10 minutes when the difference of set temperature and room temperature is more than 2°C, the swing operation is performed in table D~H for more cooling.

The air conditioner repeats the swing operation in various cycle as follows.

	Temperature of indoor coil thermistor RT12	Downward blow time (second)	Horizontal blow time (second)
A	15°C or less	2	23
B	15°C to 17°C	5	20
C	17°C to 18°C	8	17
D	18°C to 20°C	11	14
E	20°C to 21°C	14	11
F	21°C to 22°C	17	8
G	22°C to 24°C	20	5
H	more than 24°C	23	2

2. Vertical vane

(1) Vane motor drive

These models are equipped with a stepping motor for the vertical vane. The rotating direction, speed, and angle of the motor are controlled by pulse signals (approximate 12V) transmitted from microprocessor.

(2) The vertical vane angle and mode change as follows by pressing WIDE VANE button.

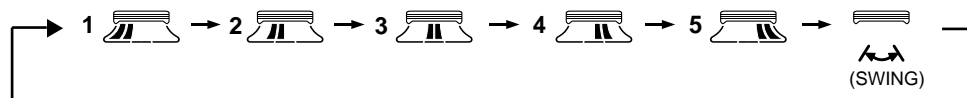

(3) Positioning

The vane presses the vane stopper once to confirm the standard position and then set to the desired angle.

Confirming of standard position is performed in case of follows.

(a) When OPERATE/STOP(ON/OFF) button is pressed (POWER ON).

(b) When SWING is started.

(4) SWING MODE ()

By selecting SWING mode with WIDE VANE button, the vertical vane swings horizontally. The remote controller displays "  ". Swing mode is cancelled when WIDE MODE button is pressed once again.

5-8. i-see CONTROL OPERATION

The sensors constantly measure the room and floor/wall temperatures to automatically adjust to the set temperature by estimating the temperature actually perceived by a person inside the room ("sensory temperature").

Advantages

- The air inside the room is conditioned quickly to a comfortable condition.
- The room will not become too cold or hot even when the air conditioner is kept on for a long period.
- The air conditioner will not overcool or overheat, which means you can save on electricity.

i-see control operation is activated when i-see button is pressed with a thin stick in manual COOL or manual HEAT mode.

NOTE :

i-see control operation is activated when the remote controller is first used following replacement of the batteries or resetting of the remote controller.

i-see control operation is cancelled when i-see button is pressed with a thin stick once again.

NOTE :

If the conditioner is turned OFF without cancelling i-see control operation, i-see control operation is activated the next time the air conditioner is turned ON.

i-see Sensor

i-see Sensor, which is installed on the right side of the air outlet of the indoor unit, is moved with the stepping motor and it detects the floor/ wall temperature.

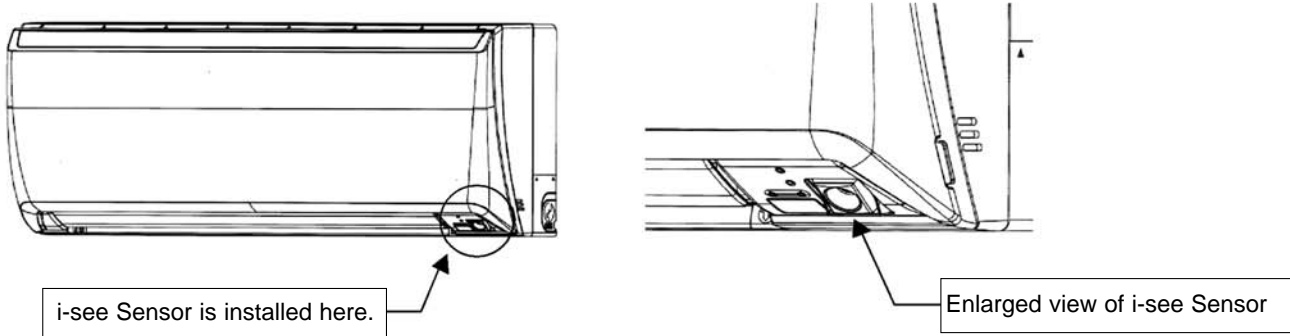

i-see Sensor			
<ul style="list-style-type: none"> When AREA setting is not activated, the sensing range of i-see Sensor differs depending on the installation location of the air conditioner. 			
Installation position	Installed at left	Installed at center	Installed at right
Image of sensing range			
Direction of sensor	Right	Center	Left
Refer to the description on service manual OB371 (8-4. Remote controller) for slide switch setting.			
<ul style="list-style-type: none"> Install the front panel correctly after being removed for maintenance or service so that the floor/wall temperatures can be measured correctly. 			

5-9. AREA () SETTING

- Press OPERATE / STOP (ON/ OFF) button to start the air conditioner.
- Press i-see button. (NOTE 1)
- Press AREA button.

Each time the button is pressed, the area is changed in sequence:

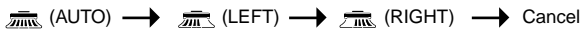

i-see Sensor moves intermittently, measuring the floor and wall temperature.

NOTE1: AREA setting is only available during i-see control operation.

NOTE2: If AREA setting is canceled, the vertical vane returns to the previously set position before AREA setting.

NOTE3: The horizontal air flow direction (WIDE VANE button), including horizontal SWING, cannot be set during AREA setting.

Moving of horizontal air flow direction	<ul style="list-style-type: none"> If AREA setting is set to AUTO in heating operation, the indoor unit automatically delivers warm air to the area where the floor/wall temperature is the lowest in the room. If AREA setting is set to AUTO in cooling operation, the indoor unit automatically delivers cool air to the area where the floor/wall temperature is the highest in the room. <p>Ex.) In heating operation</p> <p>The indoor unit delivers warm air detecting the cold area in the room.</p>
Indoor unit display	Indication of AREA setting
NOTE	<ul style="list-style-type: none"> The horizontal air flow direction changes if i-see Sensor detects approx. 3°C temperature difference. In AUTO of AREA setting, both right and left lamps are lighted when the room is evenly air-conditioned.

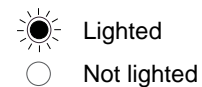

(4) AREA setting is cancelled when the "cancel" is selected by pressing AREA button, or when WIDE VANE button is pressed.

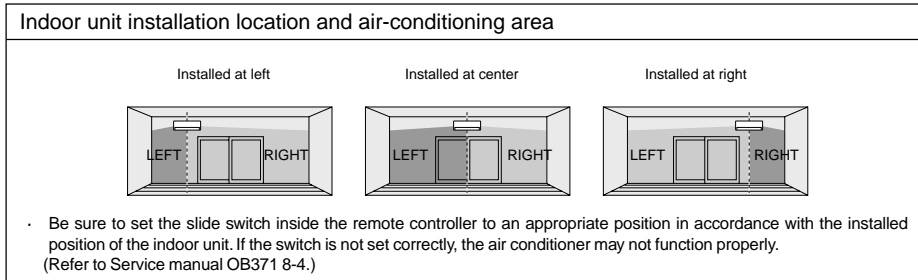

	To air-condition mainly the left area of the room	To air-condition the entire room The horizontal air flow direction and indoor unit display are switched according to the room temperature (floor/wall).	To air-condition mainly the right area of the room
Remote controller button	Press AREA button to select LEFT.	Press AREA button to select AUTO.	Press AREA button to select RIGHT.
Remote controller display			
i-see Sensor operation			
Control range of horizontal air flow direction. The vertical air flow direction conforms to the setting on the remote controller. (The horizontal air flow direction is controlled in this range.)	Installed at center 		
	Installed at left 		
	Installed at right 		
Indoor unit display	AREA	AREA or or	AREA

NOTE: If the AREA setting is activated (AUTO), i-see Sensor moves in a range of 150 degrees detecting floor/wall temperature of 3 area (left, right, center). Therefore, the detected temperatures may be different from the temperatures measured on commercial thermometers depending on the condition or temperature distribution on the floor and/or wall.

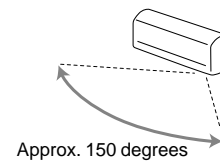

Operation and operating range

i-see sensor moves 30 degrees from the center in both right and left side.

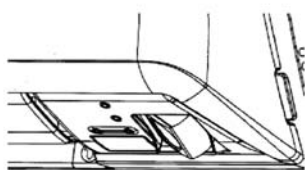

i-see Sensor turning to the left

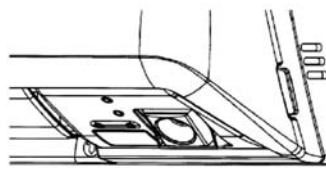

i-see Sensor turning to the center

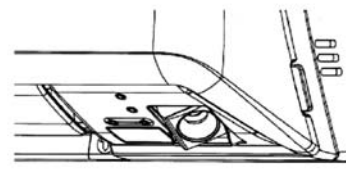

i-see Sensor turning to the right

i-see Sensor operates as follows in accordance with AREA setting made with the remote controller.

“AUTO” in AREA setting; first turning to the LEFT for adjusting the position then.....
 CENTER → RIGHT → CENTER → LEFT → CENTER.....
 (The sensor turns to the right, left and center.)

“RIGHT” in AREA setting; first turning to the LEFT for adjusting the position then....
 CENTER → RIGHT → CENTER → RIGHT → CENTER.....
 (The sensor turns to the right and center.)

“LEFT” in AREA setting; first turning to the LEFT for adjusting the position then....
 CENTER → LEFT → CENTER → LEFT → CENTER.....
 (The sensor turns to the left and center.)



The sensor finishes turning to one area to another for 3 seconds and it operates one area for 5 seconds.

5-10. PLASMA DUO () OPERATION

(1) Press OPERATE/STOP (ON/OFF) button to start the air conditioner.

(2) Press PLASMA button to set PLASMA DUO operation.

Each time this button is pressed, the operation mode of PLASMA is changed in sequence:

 →  →  → Cancel (The sign of PLASMA operation disappears.)

PLASMA/WASH lamp turns on in the display section of the indoor unit and PLASMA DEODORIZING and/or PLASMA AIR PURIFYING unit is energized. Adjust the air flow to your desired speed.

(3) PLASMA operation is cancelled when the "cancel" is selected by pressing PLASMA button.

Once PLASMA operation is selected, PLASMA operation will be performed every time the air conditioner is turned on until the "Cancel" is selected with PLASMA button.

- Never touch the PLASMA DEODORIZING/AIR PURIFYING filter units during the operation of the air conditioner. Although the filter units are safety-conscious design, touching the units could be the cause of trouble as they discharge high voltage electricity.

PLASMA/WASH lamp

POWER ○

PLASMA/WASH 

AREA  L  R

 Lighted
 Not lighted

Description of PLASMA DUO operation:

< function>

Both PLASMA DEODORIZING and PLASMA AIR PURIFYING operation work.

< function>

PLASMA DEODORIZING operation cleans the air inside the room by adsorbing and decomposing the particles of odor-releasing substances and gases such as formaldehyde.

< function>

PLASMA AIR PURIFYING operation cleans the air inside the room by absorbing the particles of cigarette smoke or allergens such as pollens and house dust.

NOTE1: Carbon monoxide released from cigarettes cannot be removed by PLASMA operation. Open the windows to let the outside air in from time to time.

NOTE2: During PLASMA operation, you may smell ozone that is generated in small quantities from PLASMA DEODORIZING/AIR PURIFYING filter units. This is not a malfunction.

NOTE3: You may hear a small "hissing" sound during PLASMA operation. This is the sound of plasma discharge, and not a malfunction.

<Cleaning>

When PLASMA/WASH lamp is blinking, please clean PLASMA DEODORIZING/AIR PURIFYING filter units. After cleaning of PLASMA DEODORIZING/AIR PURIFYING filter units, press WASH reset switch. A short "beep" is heard and the blinks of PLASMA/WASH lamp will be cancelled.

PLASMA/WASH lamp

POWER ○

PLASMA/WASH 

AREA  L  R

 Lighted

 Blinking

○ Not lighted

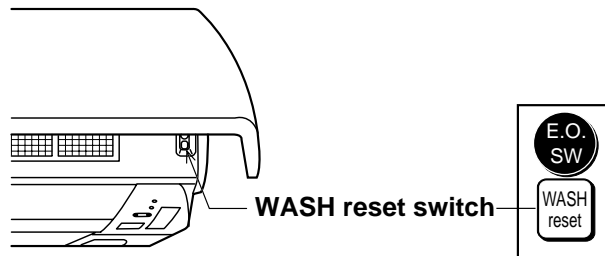

5-11. AUTO FRONT PANEL

When the unit starts operating, the front panel opens automatically to draw in air.
When the unit stops operating, the front panel closes automatically.

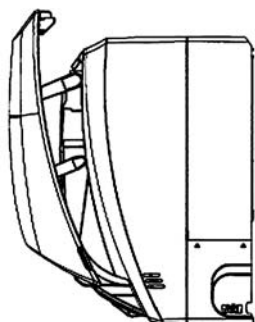

Open

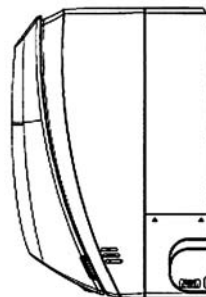

Closed

Operation and operating range of the auto front panel

The front panel fully opens 10 mm or more upper than the level line of the top end of the nozzle assembly.
It takes about 13 seconds to open the front panel completely.

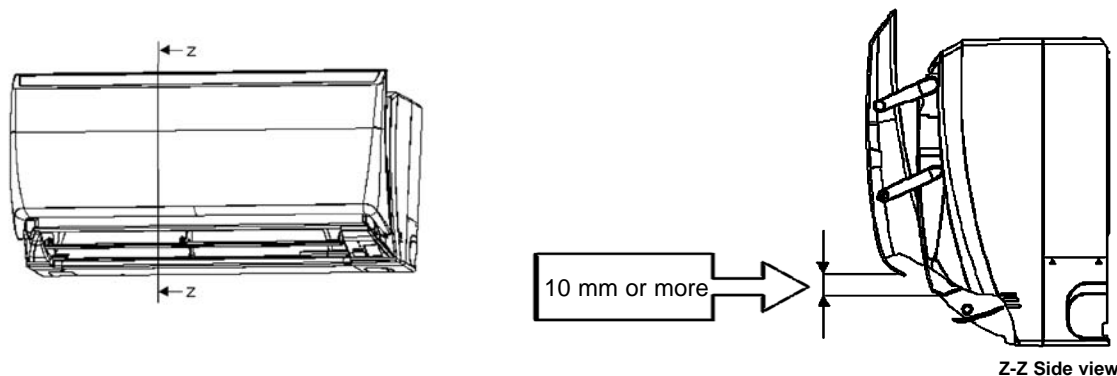

Z-Z Side view





5-12. TIMER OPERATION

1. How to set the timer





- (1) Press OPERATE/STOP (ON/OFF) button to start the air conditioner.
- (2) Check that the current time is set correctly.

NOTE : Timer operation will not work without setting the current time. Initially "AM0:00" blinks at the current time display of TIME MONITOR, so set the current time correctly with CLOCK SET button.

ON timer setting

- (1) Press ON-TIMER button () to set ON timer.
Each time the button is pressed, ON timer mode alternates between ON and OFF.
- (2) Set the time of the timer using TIME SET buttons ( and ).
Each time FORWARD button () is pressed, the set time increases by 10 minutes; each time BACKWARD button () is pressed, the set time decreases by 10 minutes.

OFF timer setting

- (1) Press OFF-TIMER button () to set OFF timer.
Each time the button is pressed, OFF timer mode alternates between ON and OFF.
- (2) Set the time of the timer using TIME SET buttons ( and ).
Each time FORWARD button () is pressed, the set time increases by 10 minutes; each time BACKWARD () button is pressed, the set time decreases by 10 minutes.

2. Cancel

TIMER setting can be cancelled with ON/OFF TIMER buttons.

To cancel ON timer, press ON-TIMER button ().

To cancel OFF timer, press OFF-TIMER button ().

TIMER is cancelled and the display of set time disappears.

PROGRAM TIMER

- The OFF timer and ON timer can be used in combination. The timer of the set time that is reached first will operate first.
- “↑” and “↓” display shows the order of the OFF timer and the ON timer operation.

(Example 1) The current time is 8:00 PM.
The unit turns off at 11:00 PM, and on at 6:00 AM.

(Example 2) The current time is 11:00 AM.
The unit turns on at 5:00 PM, and off at 9:00 PM.

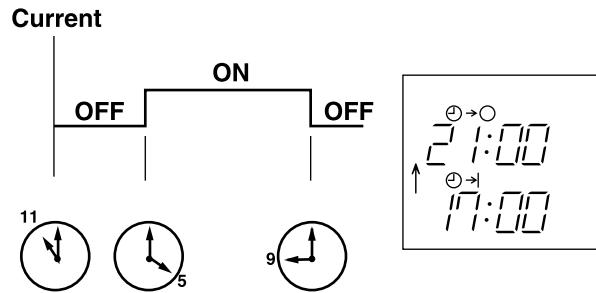
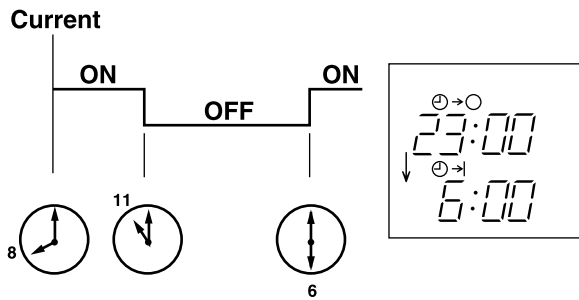

NOTE : If the main power is turned off or a power failure occurs while AUTO START/STOP timer is active, the timer setting is cancelled. As these models are equipped with an auto restart function, the air conditioner starts operating with timer cancelled when power is restored.

5-13. EMERGENCY / TEST OPERATION

In case of test run operation or emergency operation, use EMERGENCY OPERATION switch on the front of the indoor unit. Emergency operation is available when the remote controller is missing, has failed or the batteries of the remote controller run down. The unit will start and AREA lamp will light.

The first 30 minutes of operation is the test run operation. This operation is for servicing. The Indoor fan speed runs at High speed and the system is in continuous operation (The thermostat in ON).

After 30 minutes of test run operation, the system shifts to EMERGENCY COOL / HEAT MODE with a set temperature of 24°C. The fan speed shifts to Med..

The coil frost prevention works even in emergency operation, and defrosting too.

In the test run or emergency operation, the horizontal vane operates in VANE AUTO (@) mode.

Emergency operation continues until EMERGENCY OPERATION switch is pressed once or twice or the unit receives any signal from the remote controller. In case of latter, normal operation will start.

NOTE1 : Do not press EMERGENCY OPERATION switch during normal operation.

NOTE2 : 3 seconds after EMERGENCY OPERATION switch is pressed, the front panel starts moving forward automatically.

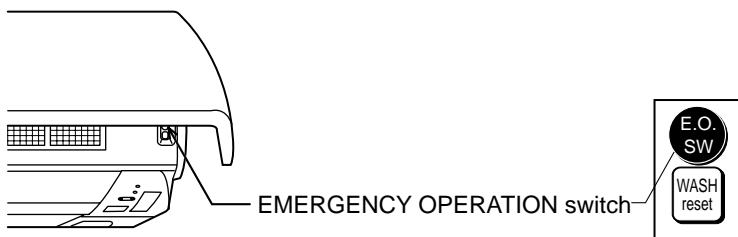

Operation mode	COOL	HEAT
Set temperature	24°C	24°C
Fan speed	Medium	Medium
Horizontal vane	Auto	Auto
Vertical vane	Straight	Straight

The operation mode is indicated by the Operation Indicator lamp on the indoor unit as following figure.

Operation Indicator lamp

- Press once <Cool> AREA Lighted
- Press again <Heat> AREA Lighted
- Press once again <Stop> AREA Not lighted

NOTE:

This is the indication of EMERGENCY OPERATION mode. AREA setting is not available during EMERGENCY OPERATION.

5-14. INVERTER SYSTEM CONTROL

5-14-1. Inverter main power supply circuit

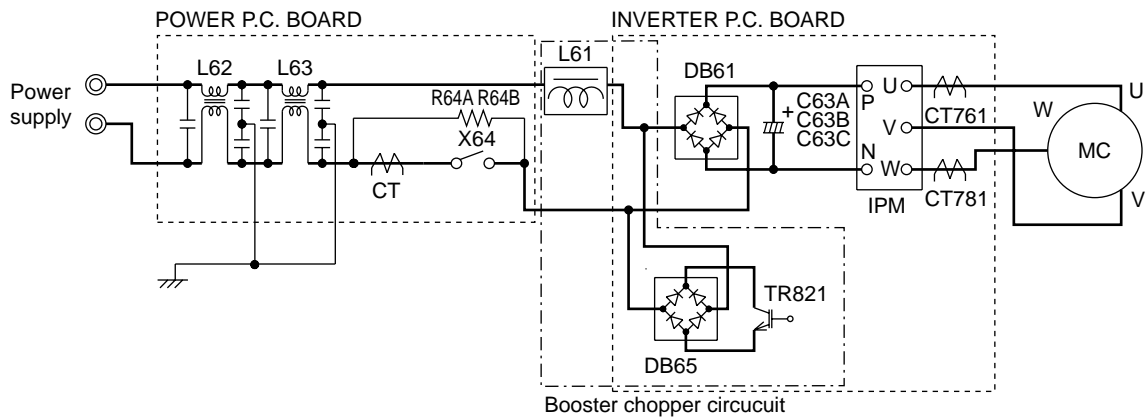

Function of main parts

SYMBOL	NAME	FUNCTION	
IPM	INTELLIGENT POWER MODULE	It supplies three-phase AC power to compressor.	
C63A/C63B/C63C	SMOOTHING CAPACITOR	It stabilizes the DC voltage.	
CT761/CT781	CURRENT TRANSFORMER	It measures the current of the compressor motor.	
CT	CURRENT TRANSFORMER	It measures the value of current which is supplied to the main power supply circuit.	
DB61	DIODE MODULE	It converts the AC voltage to DC voltage.	
R64A, R64B	CURRENT-LIMITING RESISTOR	It absorbs the rush current not to run into the main power supply circuit when the electricity turns ON.	
X64	RELAY	It short-circuits the resistance which restricts rush current during the normal operation after the compressor startup.	
DB65	DIODE MODULE	Booster chopper circuit	It improves power factor. It rectifies AC and controls its voltage.
TR821	SWITCHING POWER TRANSISTOR		
L61	REACTOR		

5-14-2. Outline of main power supply circuit

1. At the start of operation

Main power supply circuit is formed when X64 (Relay) is turned ON at compressor startup.

To prevent rush current from running into the circuit when power supply is turned ON, R64A and R64B (Current-limiting resistor) are placed in sub circuit.

2. At normal operation

- ① When AC runs into POWER P.C. board, its external noise is eliminated in the noise filter circuit.
- ② After noise is eliminated from AC, it is rectified to DC by DB61 (Diode module).
- ③ DC voltage, to which AC has been rectified by process ②, is stabilized by C63A, C63B and C63C (Smoothing capacitor) and supplied to IPM (Intelligent power module).
- ④ DC voltage, which has been stabilized in process ③, is converted to three-phase AC by IPM and supplied to compressor.
- ⑤ CT761 and CT781 (Current Transformer), which are placed in the power supply circuit to compressor, are used to measure the value of phase current and locate the polar direction of rotor with algorithm. PWM (Pulse width modulation) controls impressed voltage and frequency with those information.

3. Purpose of PAM adoption

PAM : Pulse Amplitude Modulation

PAM has been adopted for the efficiency improvement and the adaptation to IEC harmonic current emission standard.

Outline of simple partial switching method

In conventional inverter models, diode module rectifies AC voltage to DC voltage, smoothing capacitor makes its DC waveform smooth, and IPM converts its DC voltage to imitated AC voltage again in order to drive the compressor motor.

However, it has been difficult to meet IEC harmonic current emission standard by above circuit because harmonic gets generated in the input current waveform and power factor gets down. The simple partial switching method with PAM, which has been adopted this time, places and utilizes the booster chopper circuit (L61, DB65 and TR821) before rectifying AC voltage in the general passive-method converter circuit. As harmonic gets suppressed and the peak of waveform gets lower by adding booster chopper circuit as mentioned above and by synchronizing the timing of one-time switching with the zero-cross point of waveform, the input current waveform can be improved and the requirement of IEC harmonic current emission standard can be satisfied. Since the switching times is just once by synchronizing with the zero cross point, this simple partial switching method has the feature of lower energy loss compared to active filter method. In addition, output and efficiency is enhanced by combining with vector-controlled inverter in order to boost the voltage of power supplied to IPM.

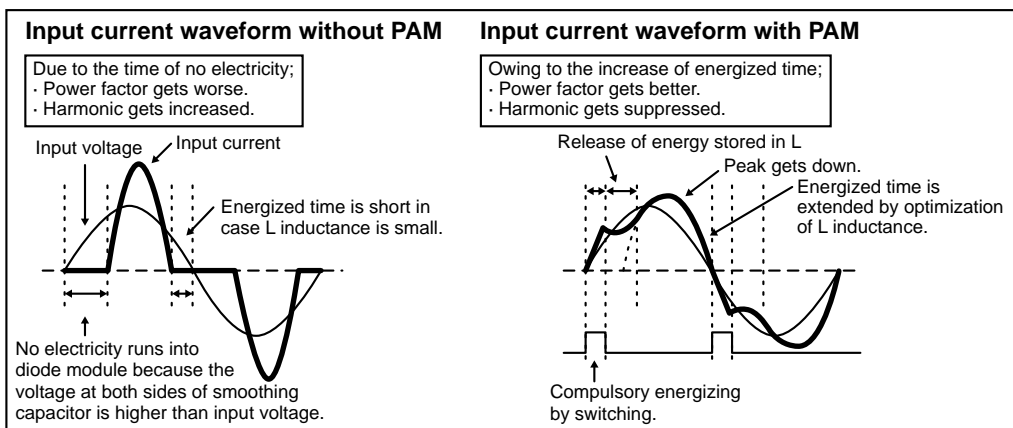

4. Intelligent power module

IPM consists of the following components

- IGBT (x6) : Converts DC waveform to three-phase AC waveform and outputs it.
- Drive Circuit : Drives transistors.
- Protection circuit : Protects transistors from overcurrent.

Since the above components are all integrated in IPM, IPM has a merit to make the control circuit simplify and miniaturize.

5. Smoothing capacitor

C63A, C63B and C63C stabilize the DC voltage and supply it to IPM.

6. Elimination of electrical noise

Noise filter circuit, which is formed by *CMC COILS capacitors placed on the POWER P.C. board, eliminates electrical noise of AC power that is supplied to main power supply circuit. And this circuit prevents the electrical noise generated in the inverter circuit from leaking out.

*CMC COILS; Common mode choke coils

Sine wave control

In these air conditioners, compressor equips brushless DC motor which doesn't have Hall element.

In short, the motor is sensorless. However, it's necessary to locate the polar direction of rotor in order to drive brushless DC motor efficiently. The general detection method of the polar direction for such a DC motor is to locate it from the voltage induced by unenergized stator.

Therefore, It is necessary to have a certain period of time in which the stator is being unenergized for the rotor position detection when the voltage of supplied power is impressed.

So the motor has been driven by square wave control (the conventional motor drive system) which energizes the motor only when the range of electrical angle is within 120° because it is forced to be unenergized within 30° at start & end of one heap in one waveform cycle (180°) when the voltage is impressed.

However, torque pulsation occurs at rotation in this method when the current-carrying phases are switched over to other phases in sequence. Therefore, sine wave control system is adopted for these air conditioners because it can make the phase-to-phase current waveform smoother (sine wave) in order to drive the motor more efficiently and smoothly.

5-14-3. Characteristics of sine wave control in case of brushless DC motor

- Although ordinary three-phase induction motor requires energy to excite the magnetic field of rotor, brushless DC motor doesn't need it. So, higher efficiency and torque are provided.
- This control provides the most efficient waveform corresponding to the rotation times of compressor motor.
- The rotation can be set to higher compared to the conventional motor drive system. So, the time in which air conditioner can be operated with energy saved is longer than conventional models. This can save annual electric consumption.
- Compared to square wave control, the torque pulsation is reduced at rotation so that the motor operates more quietly.
- Since response and efficiency of motor are enhanced in sine wave control, finer adjustment can be provided.

	DC Motor	AC Motor
Rotor	Permanent magnet is embedded.	Excited by magnetic field of stator
Rotor Position Signal	Necessary	Unnecessary

※ In brushless DC motor, permanent magnet is embedded in the rotor. Therefore, it doesn't require energy to excite the rotor like AC motor does. However, it's necessary to control the frequency of three-phase AC current supplied to the stator according to the polar direction of magnet embedded in the rotor so as to drive the motor efficiently. Controlling three-phase AC current frequency also means controlling the timing to switch the polarity of stator. Therefore, the polar direction of rotor needs to be detected.

5-14-4. Control Method of Rotation Times

Sine wave control makes the current transformers conduct real time detection of the value of the current running into the motor, locates the rotor position from the detected value, and decides if voltage should be impressed and if frequency should be changed.

Compared to the conventional control and rotor position detection method, sine wave control can provide finer adjustment of the voltage of supplied power. The value of the current running into the motor is determined by each motor characteristic.

5-15. OPERATIONAL FREQUENCY CONTROL OF OUTDOOR UNIT

1. Outline

The operational frequency is as following:

First, the target operational frequency is set based on the difference between the room temperature and the set temperature.

Second, the target operational frequency is regulated by discharge temperature protection, high pressure protection, electric current protection and overload protection and also by the maximum/minimum frequency.

2. Maximum/minimum frequency in each operation mode

Applied model	COOL			HEAT			DRY	
	Minimum frequency	Rated frequency	Maximum frequency	Minimum frequency	Rated frequency	Maximum frequency	Minimum frequency	Maximum frequency
MUZ-FA25VA MUZ-FA25VAH	28	57	98	45	77	105	28	58
MUZ-FA35VA MUZ-FA35VAH	28	70	86	35	73	98	28	57

※ The operation frequency in COOL mode is restricted the upper limit frequency after 1 hour as shown below for dew prevention.

It is rated frequency or less.

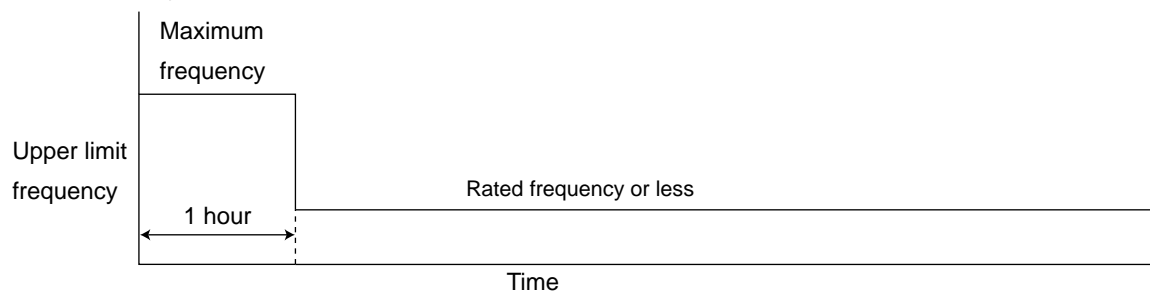

5-16. EXPANSION VALVE CONTROL (LEV CONTROL)

(1) Outline of LEV control

The LEV basic control is comprised of setting LEV opening degree to the standard opening degrees set for each operational frequency of the compressor. However, when any change in indoor/outdoor temperatures or other factors cause air conditioning load fluctuation, the LEV control also works to correct LEV opening degree based on discharge temperature (Shell temperature) of the compressor, developing the unit's performance.

standard specification	Control range	from minimum 33 pulse to maximum 500 pulse.
	Actuating speed	LEV opens 40 pulse/second and close 90 pulse/second
	Opening degree adjustment	LEV opening degree is always adjusted in opening direction. (When reducing the opening degree, LEV is once over-closed, and then adjusted to the proper degree by opening.
general operation	Unit OFF	LEV remains at maximum opening degree (reaches maximum opening degree approximate in 15 minutes after compressor stops)
	Remote controller ON	LEV is positioned. (first full-closed at zero pulse and then positioned.)
	COOL · DRY MODE During 1 to 5 minutes after compressor starts	LEV is fixed to standard opening degree according to operational frequency of compressor.
	HEAT MODE During 1 to 15 minutes after compressor starts	
	More than COOL, DRY: 5/ HEAT: 15 minutes have passed since compressor start-up	LEV opening degree is corrected to get target discharge temperature of compressor. (For discharge temperature lower than target temperature, LEV is corrected in closing direction.) (For discharge temperature higher than target temperature, LEV is corrected in opening direction.) ※It may take more than 30 minutes to reach target temperature, depending on operating conditions.
	Thermostat OFF	LEV is adjusted to exclusive opening degree for thermostat OFF.
Thermostat ON	LEV is controlled in the same way as that after the compressor has started up.	
Defrosting in HEAT mode	LEV is adjusted to open 500 pulse.	

(2) Time chart

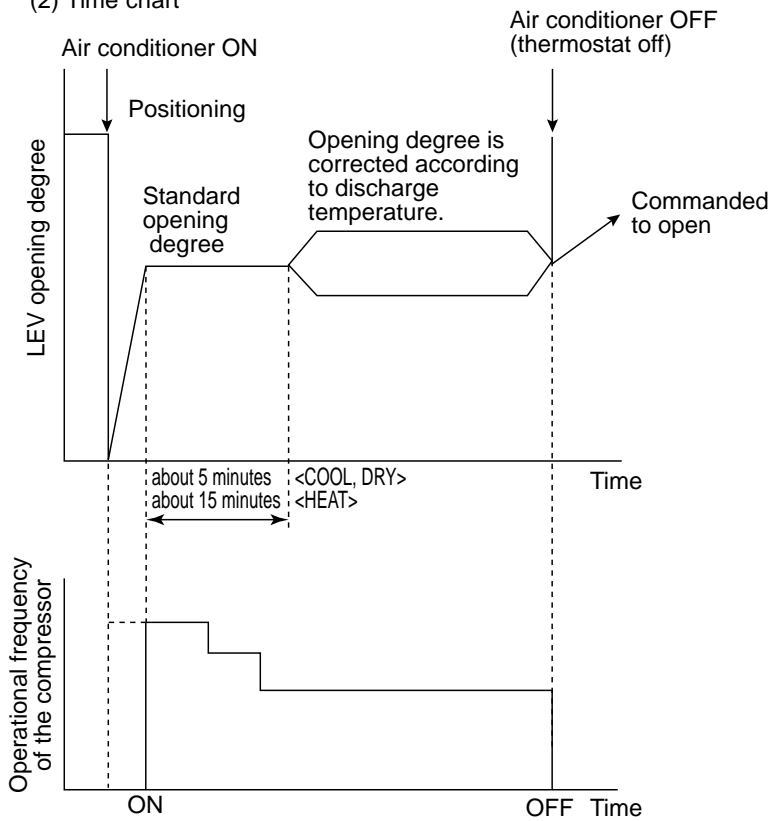

(3) Control data

(a) Reference value of target discharge temperature (COOL/HEAT °C)

	A	B	C	D	E	F
MUZ-FA25VA MUZ-FA25VAH	47/41	53/48	58/55	63/60	67/65	67/65
MUZ-FA35VA MUZ-FA35VAH	50/45	53/52	60/59	66/68	70/76	70/76

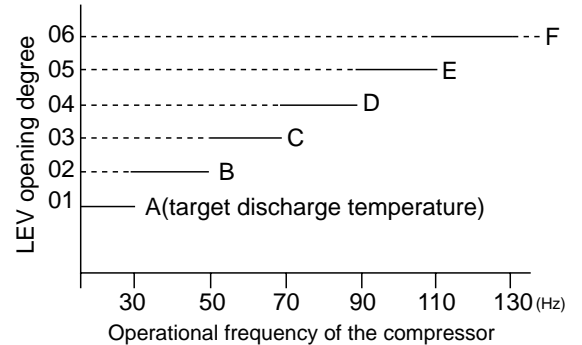

In COOL operation, the two indoor coil thermistors (one main and one sub) sense temperature ununiformity (super heat) at the heat exchanger, and when temperature difference have developed, the indoor coil thermistors adjust LEV opening degree to get approximate 10 degrees lower temperature than the target temperature in the table above, thus diminishing super heat.

(b) Reference value of LEV standard opening degree (COOL/ HEAT pulse)

	01	02	03	04	05	06
MUZ-FA25VA MUZ-FA25VAH	150/110	190/110	240/150	280/170	310/200	340/230
MUZ-FA35VA MUZ-FA35VAH	130/100	190/130	240/170	260/210	260/230	260/230

6 MSZ-GA • MSZ-CB MICROPROCESSOR CONTROL

MSZ-GA22VA MSZ-CB22VA
 MSZ-GA25VA MSZ-CB25VA MUZ-GA25VA MUZ-GA25VAH
 MSZ-GA35VA MSZ-CB35VA MUZ-GA35VA MUZ-GA35VAH

WIRELESS REMOTE CONTROLLER

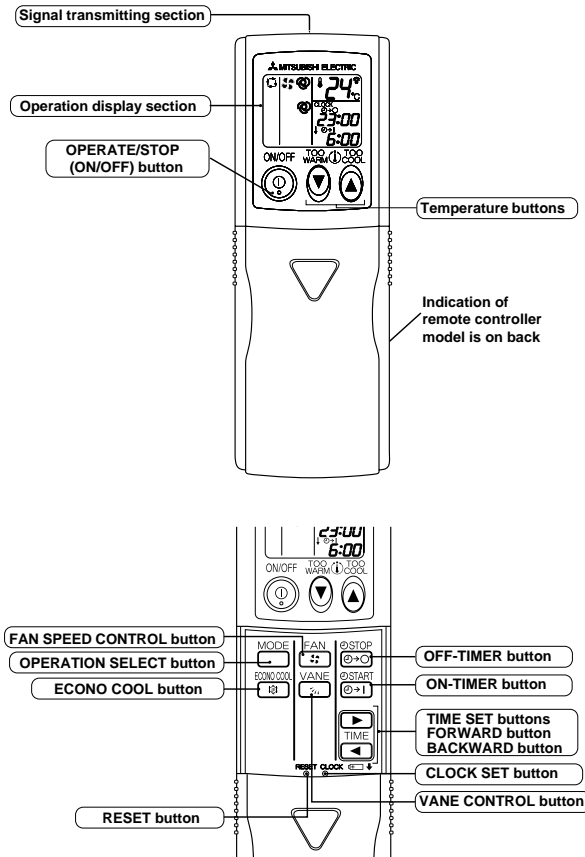

Once the operation mode is set, the same operation mode can be repeated by simply turning OPERATE/STOP (ON/OFF) button ON.
 Indoor unit receives the signal with a beep tone.
 When the system turns off, 3-minute time delay will operate to protect system from overload and compressor will not restart for 3 minutes.

INDOOR UNIT DISPLAY SECTION

Operation Indicator lamp

The operation indicator at the right side of the indoor unit indicates the operation state.

•The following indication applies regardless of shape of the indicator.

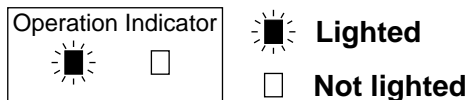

Indication	Operation state	Difference between target temperature and room temperature
	This shows that the air conditioner is operating to reach the target temperature. Please wait until the target temperature is obtained.	Approx. 2 °C or more
	This shows that the room temperature is approaching the target temperature.	Approx. 2 °C or less

6-1. COOL (❄) OPERATION

- (1) Press OPERATE/STOP(ON/OFF) button.
OPERATION INDICATOR lamp of the indoor unit turns on with a beep tone.
- (2) Select COOL mode with OPERATION SELECT button.
- (3) Press TEMPERATURE buttons (TOO WARM or TOO COOL button) to select the desired temperature.
The setting range is 16 ~ 31°C

1. Thermostat control

Thermostat is ON or OFF by difference between room temperature and set temperature

Initial temperature difference	Thermostat	Set temperature
Room temperature minus set temperature : $-1.0\text{ }^{\circ}\text{C}$ or more	ON	
Room temperature minus set temperature : less than $-1.0\text{ }^{\circ}\text{C}$	OFF	

2. Indoor fan speed control

Indoor fan operates continuously at the set speed by FAN SPEED CONTROL button regardless of the thermostat's OFF-ON.
In AUTO the fan speed is as follows.

Initial temperature difference	Fan speed	Difference between room temperature and set temperature during operation
Room temperature minus set temperature : $1.7\text{ }^{\circ}\text{C}$ or more	High	
Room temperature minus set temperature : Between 1 and $1.7\text{ }^{\circ}\text{C}$	Med.	
Room temperature minus set temperature : less than $1\text{ }^{\circ}\text{C}$	Low	

3. Coil frost prevention

Temperature control

When indoor coil thermistor detects following temperature for 90 seconds, operational frequency of compressor is controlled according to the following table.

Temperature of indoor coil thermistor	Operation frequency
$10\text{ }^{\circ}\text{C}$ or more	Normal (variable)
$8\text{ }^{\circ}\text{C}$ to $10\text{ }^{\circ}\text{C}$	Raise 6Hz
$6\text{ }^{\circ}\text{C}$ to $8\text{ }^{\circ}\text{C}$	Fixed
$3\text{ }^{\circ}\text{C}$ to $6\text{ }^{\circ}\text{C}$	Lower 3Hz
$3\text{ }^{\circ}\text{C}$ or less	Lower 6Hz Compressor is turned OFF for 5 minutes when temperature of indoor coil thermistor continues $3\text{ }^{\circ}\text{C}$ or less for 5 minutes or more.

The indoor fan maintains the actual speed of the moment.

4. Low outside temperature operation

MUZ-GA25

When the ambient temperature thermistor RT65 reads $17\text{ }^{\circ}\text{C}$ or less, the operation mode moves to cool operation in low outside temperature from normal cool operation.

Each outdoor actuator (compressor/ fan/ solenoid valve) is operated in the exclusive control, which is different from one of normal cool operation.

Especially fan motor doesn't operate continuously to maintain sufficient cooling capacity.

(1) Outdoor fan control

Outdoor unit (compressor) operates with outdoor fan OFF basically.

But any of following conditions is satisfied, the outdoor fan turns ON for about 5 seconds.

- a). the defrost thermistor RT61 reads $50\text{ }^{\circ}\text{C}$ or more.
- b). the fin temperature thermistor RT64 reads $60\text{ }^{\circ}\text{C}$ or more.

(2) Solenoid valve control

In low outside temperature operation solenoid valve coil is energized and solenoid valve is open.

(3) Dew drop prevention

When the ambient temperature thermistor RT65 reads $-12\text{ }^{\circ}\text{C}$ or less, as coil frost or dew drop from indoor unit may occur, the compressor turns OFF with the outdoor fan ON for prevention of them.

NOTE: This control can be released by cut of the jumper line JG on the outdoor inverter P.C. board.

Be sure to cut it since user accepts that maker can't be responsible for coil frost or dew drop from indoor unit.

(4) Outside temperature detecting control

In this mode to detect the exact outside temperature the compressor turns OFF with the outdoor fan ON for 3 minutes once 1 hour.

MUZ-GA35

If the outside temperature falls to $18\text{ }^{\circ}\text{C}$ or less during operation in COOL mode, the unit enters the low outside temperature operation mode.

<Operation>

- (1) If the unit enters the low outside temperature operation mode, the outside fan rotation speed gets slow down.
- (2) Even when the unit is in the "thermostat-off" status under the low outside temperature operation mode, the outside fan rotation does not stop.
- (3) In this mode to detect the exact outside temperature the compressor turns OFF with the outdoor fan ON for 3 minutes once 1 hour; if the outside temperature rises over $18\text{ }^{\circ}\text{C}$, the unit goes back to the normal COOL mode, and if the outside temperature is still $18\text{ }^{\circ}\text{C}$ or less, the unit stays in the low outside temperature operation mode.
- (4) Dew drop prevention
When the ambient temperature thermistor RT65 reads $-12\text{ }^{\circ}\text{C}$ or less, as coil frost or dew drop from indoor unit may occur, the compressor turns OFF with the outdoor fan ON for prevention of them.

*Other protections work as well as in the normal COOL mode.

6-2. DRY (\triangle) OPERATION

- (1) Press OPERATE/STOP(ON/OFF) button.
OPERATION INDICATOR lamp of the indoor unit turns on with a beep tone.
- (2) Select DRY mode with OPERATION SELECT button.
- (3) The microprocessor reads the room temperature and determines the set temperature. Set temperature is as shown on the right chart.

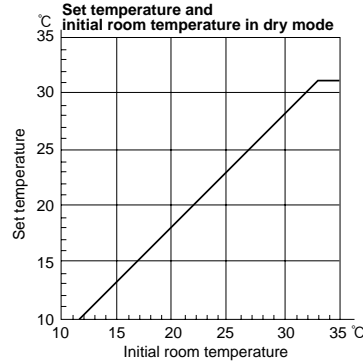

The system for dry operation uses the same refrigerant circuit as the cooling circuit. The compressor and the indoor fan are controlled by the room temperature.

By such controls, indoor flow amounts will be reduced in order to lower humidity without much room temperature decrease.

1. Thermostat control

Thermostat is ON or OFF by difference between room temperature and set temperature.

Difference between room temperature and set temperature during operation

Initial temperature difference	Thermostat	Set temperature
Room temperature minus set temperature : $-1.0\text{ }^{\circ}\text{C}$ or more	ON	
Room temperature minus set temperature : less than $-1.0\text{ }^{\circ}\text{C}$	OFF	

2. Indoor fan speed control

Indoor fan operates at the set speed by FAN SPEED CONTROL button. When thermostat OFF (compressor OFF) fan speed becomes Very Low.

In AUTO the fan speed is as follows.

Initial temperature difference	Fan speed	Difference between room temperature and set temperature during operation
Room temperature minus set temperature : $1.7\text{ }^{\circ}\text{C}$ or more	High	
Room temperature minus set temperature : Between 1 and $1.7\text{ }^{\circ}\text{C}$	Med.	
Room temperature minus set temperature : less than $1\text{ }^{\circ}\text{C}$	Low	

3. Coil frost prevention

Coil frost prevention is as same as COOL mode. (6-1.3.)

The indoor fan maintains the actual speed of the moment.

4. Low outside temperature operation

Low outside temperature operation is as same as COOL mode. (6-1.4.)

6-3. HEAT (\odot) OPERATION

- (1) Press OPERATE/STOP(ON/OFF) button.
OPERATION INDICATOR lamp of the indoor unit turns on with a beep tone.
- (2) Select HEAT mode with OPERATION SELECT button.
- (3) Press TEMPERATURE buttons (TOO WARM or TOO COOL button) to select the desired temperature.
The setting range is $16\text{ }^{\circ}\text{C}$ ~ $31\text{ }^{\circ}\text{C}$.

Difference between room temperature and set temperature during operation

1. Thermostat control

Thermostat is ON or OFF by difference between room temperature and set temperature.

Initial temperature difference	Thermostat	Set temperature
Room temperature minus set temperature : less than $2.0\text{ }^{\circ}\text{C}$	ON	
Room temperature minus set temperature : $2.0\text{ }^{\circ}\text{C}$ or more	OFF	

2. Indoor fan speed control

- (1) Indoor fan operates at the set speed by FAN SPEED CONTROL button.
In Auto the fan speed is as follows.

Difference between room temperature and set temperature during operation

Initial temperature difference	Fan speed	Difference between room temperature and set temperature during operation
Set temperature minus room temperature: $2\text{ }^{\circ}\text{C}$ or more	High	
Set temperature minus room temperature: Between 0.2 and $2\text{ }^{\circ}\text{C}$	Med.	
Set temperature minus room temperature: less than $0.2\text{ }^{\circ}\text{C}$	Low	

- (2) Cold air prevention control

- ① When the compressor is not operating,
 - (I) if the temperature of room temperature thermistor RT11 is less than $19\text{ }^{\circ}\text{C}$, the fan stops.
 - (II) if the temperature of room temperature thermistor RT11 is $19\text{ }^{\circ}\text{C}$ or more and
 - (i) if the temperature of RT12 is less than $0\text{ }^{\circ}\text{C}$, the fan stops.
 - (ii) if the temperature of RT12 is $0\text{ }^{\circ}\text{C}$ or more, the fan operates at Very Low.
- ② When the compressor is operating,
 - (I) if the temperature of RT12 is $40\text{ }^{\circ}\text{C}$ or more, the fan operates at set speed.
 - (II) if the temperature of RT12 is less than $40\text{ }^{\circ}\text{C}$ and
 - (i) if heating operation starts after defrosting, the fan stops.
 - (ii) if the temperature of room temperature thermistor RT11 is $19\text{ }^{\circ}\text{C}$ or less, the fan stops.
 - (iii) if the temperature of room temperature thermistor RT11 is more than $19\text{ }^{\circ}\text{C}$, the fan operates at Very Low.

NOTE : When 3 minutes have passed since the compressor started operation, this control is released regardless of the temperature of RT11 and RT12.

3. High pressure protection

In HEAT operation the indoor coil thermistor detects the temperature of the indoor heat exchanger. The compressor operational frequency is controlled to prevent the condensing pressure from increasing excessively.

4. Overload starting

When the room temperature thermistor RT11 reads 18°C or more, the compressor runs with its maximum frequency regulated for 10 minutes after the start-up.

5. Defrosting

(1) Starting conditions of defrosting

When the following conditions a) ~ c) are satisfied, the defrosting starts.

- a) The defrost thermistor reads -3°C or less.
- b) The cumulative operation time of the compressor has reached any of the set values* (40, 45, 55, 65, 75, 85, 95, 105, 115, 125, 150 minutes).
- c) More than 5 minutes have passed since the start-up of the compressor.

* Set value of compressor operation time(hereinafter referred to as defrost interval)

This is decided by the temperature of defrost thermistor and ambient temperature thermistor, the previous defrosting time. For example, the first defrost interval is 40 minutes long, and the second is 45 minutes long. The third and subsequent intervals are set to be longer, and less frequent, depending on defrosting time.

The third and subsequent defrost intervals follow any of the three patterns ...5 or 10 to 20 minutes longer, the same, or 5 or 10 to 20 minutes shorter compared with the previous defrost interval ... with the longest 125 minutes and the shortest 40 minutes.

(2) Releasing conditions of defrosting

Defrosting is released when any of the following conditions is satisfied:

- a) The defrost thermistor continues to read 5°C or more (MUZ-GA25 / 35VA) / 8°C or more (MUZ-GA25 / 35VAH) for 30 seconds.
- b) Defrosting time has exceeded 10 minutes.
- c) Any other mode than HEAT mode is set during defrosting.

6. Defrost heater (MUZ-GA25 / GA35VAH)

(1) Starting conditions

When all of the following conditions a) ~ d) are satisfied, defrost heater turns ON to prevent ice from foaming on the base of outdoor unit.

- a) HEAT mode is selected.
- b) The ambient temperature thermistor RT65 reads 5°C or less for 5 minutes continuously. (NOTE 1).
- c) The defrost thermistor RT61 reads -1°C or less for 5 minutes continuously.
- d) Outdoor fan motor is turned ON.

(2) Releasing conditions

When any of the following conditions is satisfied, defrost heater turns OFF.

- a) Any other mode than HEAT mode is selected. (NOTE 2).
- b) The ambient temperature thermistor RT65 reads 8°C or more for 5 minutes continuously. (NOTE 1).
- c) The defrost thermistor RT61 reads more than 15°C for 5 minutes continuously.
- d) Outdoor fan motor is turned OFF.

NOTE1 : Ambient temperature thermistor RT65.

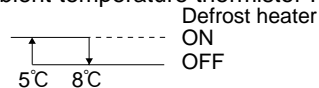

NOTE2 : During defrosting operation defrost heater continues to be ON.



Time chart of defrosting in HEAT mode (reverse type)

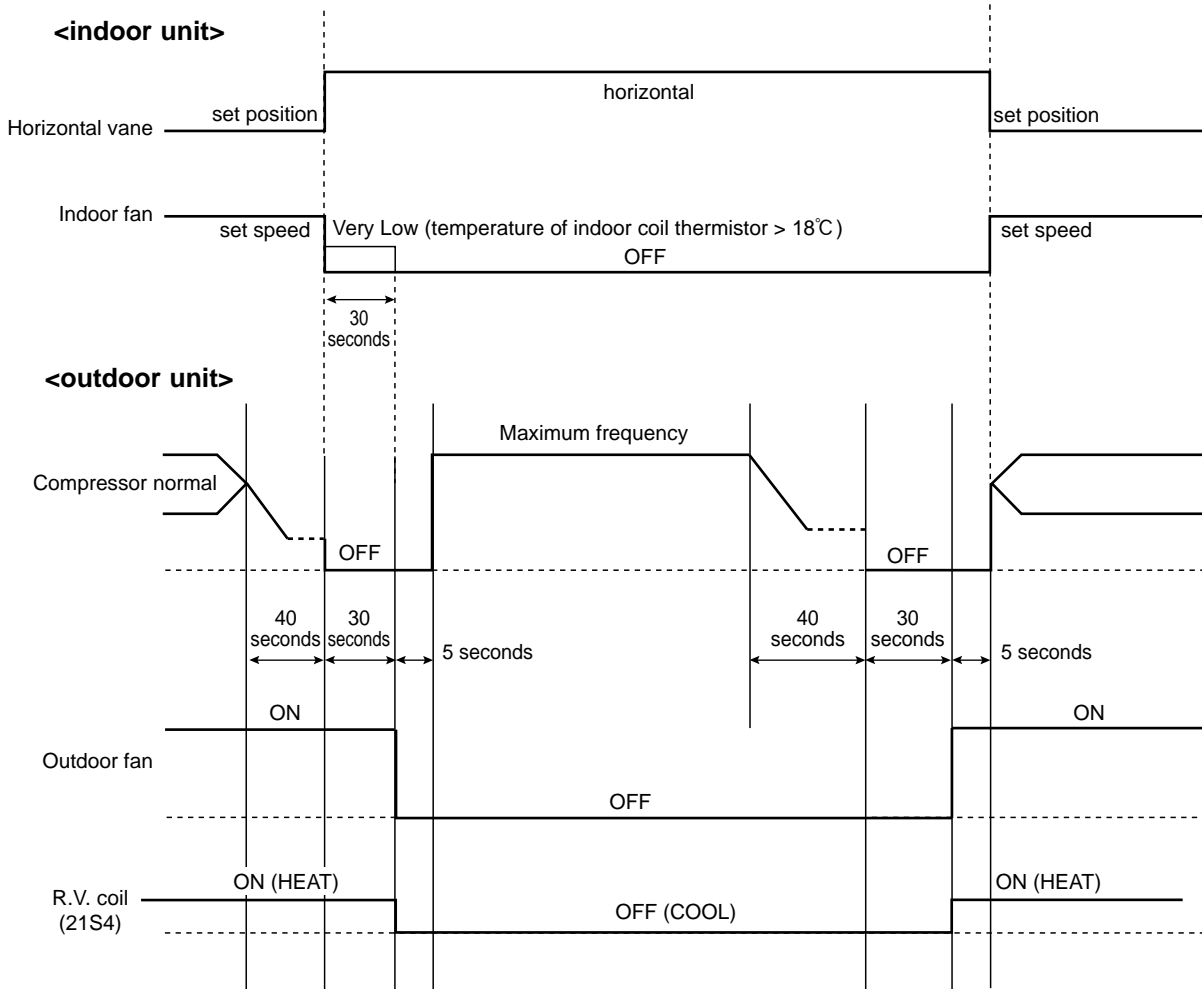

6-4. AUTO CHANGE OVER ... AUTO MODE OPERATION

Once desired temperature is set, unit operation is switched automatically between COOL and HEAT operation.

1. Mode selection

(1) Initial mode

At first indoor unit operates only indoor fan with outdoor unit OFF for 3 minutes to detect present room temperature. Following the conditions below, operation mode is selected.

- ① If the room temperature thermistor RT11 reads more than set temperature, COOL mode is selected.
- ② If the room temperature thermistor RT11 reads set temperature or less, HEAT mode is selected.

(2) Mode change

In case of the following conditions the operation mode is changed.

- ① COOL mode changes to HEAT mode when 15 minutes have passed with the room temperature 2 degrees below the set temperature.
- ② HEAT mode changes to COOL mode when 15 minutes have passed with the room temperature 2 degrees above the set temperature.

In the other cases than the above conditions, the present operation mode is continued.

NOTE1: Mode selection is performed when multi standby (refer to NOTE2) is released and the unit starts operation with ON-timer.

NOTE2: If two or more indoor units are operating in multi system, there might be a case that the indoor unit, which is operating in AUTO (□), cannot change over the other operating mode (COOL ↔ HEAT) and becomes a state of standby.

(3) Indoor fan control/ Vane control

As the indoor fan speed and the horizontal vane position depend on the selected operation mode, when the operation mode changes over, they change to the exclusive ones.

6-5. INDOOR FAN MOTOR CONTROL

(1) Rotational frequency feedback control

The indoor fan motor is equipped with a rotational frequency sensor, and outputs signal to the microprocessor to feedback the rotational frequency. Comparing the current rotational frequency with the target rotational frequency (Super High, High, Med., Low), the microprocessor adjusts fan motor electric current to make the current rotational frequency close to the target rotational frequency. With this control, when the fan speed is switched, the rotational frequency changes smoothly.



(2) Fan motor lock-up protection

When the rotational frequency feedback signal has not output for 12 seconds, (or when the microprocessor cannot detect the signal for 12 seconds) energizing to the fan motor is stopped. Then the microprocessor retries detection 3 times every 30 seconds. If the microprocessor still cannot detect the signal, the fan motor is regarded locked-up. When the fan motor lock-up, POWER lamp flashes on and off to show the fan motor abnormality.

6-6. OUTDOOR FAN MOTOR CONTROL MUZ-GA35

Fan speed is switched according to the compressor frequency.

Fan speed

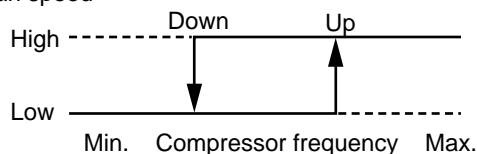

<Relation between compressor frequency and fan speed>

Mode	Fan speed	Compressor frequency
		MUZ-GA35
COOL	Up	54Hz
	Down	41Hz
HEAT	Up	54Hz
	Down	41Hz

6-7. AUTO VANE OPERATION

1. Horizontal vane

(1) Vane motor drive

These models are equipped with a stepping motor for the horizontal vane. The rotating direction, speed, and angle of the motor are controlled by pulse signals (approx. 12V) transmitted from indoor microprocessor.

(2) The horizontal vane angle and mode change as follows by pressing VANE CONTROL button.

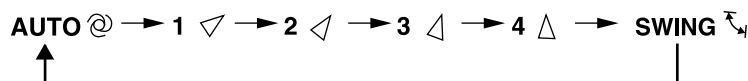

(3) Positioning

The vane presses the vane stopper once to confirm the standard position and then moves to the set angle.

Confirming of standard position is performed in case of follows.

(a) When the operation starts or finishes (including timer operation).

(b) When the test run starts.

(c) When multi-standby starts or finishes.

(4) VANE AUTO (⊙) mode

The microprocessor automatically determines the vane angle and operation to make the optimum room temperature distribution.

COOL and DRY operation

Vane angle is fixed to Horizontal position.

HEAT operation

Vane angle is fixed to Angle 4.

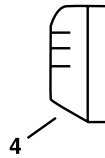
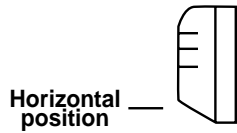

(5) STOP (operation OFF) and ON-TIMER standby

When the following cases occur, the horizontal vane returns to the closed position.

- (a) When OPERATE/STOP (ON/OFF) button is pressed (POWER OFF).
- (b) When the operation is stopped by the emergency operation.
- (c) When ON-TIMER is ON standby.

(6) Dew prevention

During COOL or DRY operation with the vane angle at Angle 2 ~ 4 when the compressor cumulative operation time exceeds 1 hour, the vane angle automatically changes to Angle 1 for dew prevention.

(7) SWING MODE (↕)

By selecting SWING mode with VANE CONTROL button, the horizontal vane swings vertically. The remote controller displays "↕". SWING mode is cancelled when VANE CONTROL button is pressed once again.

(8) Cold air prevention in HEAT operation

When any of the following conditions occurs in HEAT operation, the vane angle changes to Horizontal position automatically to prevent cold air blowing on users.

- ① Compressor is not operating.
- ② Defrosting is performed.
- ③ Indoor coil thermistor RT12 reads 24°C or below.
- ④ Indoor coil thermistor RT12 temperature is raising from 24°C or below, but it does not exceed 39°C.
- ⑤ For about 3 minutes after compressor starts.

NOTE: When 2 or more indoor units are operated with multi outdoor unit, even if any indoor unit turns thermostat off, this control doesn't work in the indoor unit.

(9) To change the air flow direction not to blow directly onto your body.

To change the air flow direction	When to use this function?	COOL/DRY	HEAT
Pressing and holding VANE CONTROL button for 2 seconds or more causes the horizontal vane to reverse and move to horizontal position.  Horizontal position	Use this function if you don't want the air from the indoor unit to blow directly onto your body. <ul style="list-style-type: none"> • Depending on the shape of the room, the air may blow directly onto your body. • Press VANE CONTROL button again to return the vane to the previously-set position. 	The air conditioner starts the cooling or drying operation approx. 3 minutes after the vane has moved to the horizontal position. <ul style="list-style-type: none"> • When VANE CONTROL button is pressed again, the vane returns to the previously-set position and the air conditioner starts the cooling or drying operation in approx. 3 minutes. 	The air conditioner starts heating operation approx. 3 minutes after the vane has moved to the horizontal position. <ul style="list-style-type: none"> • Sometimes the area around your feet may not warm. To warm the area around the feet, set the horizontal vane to ⊙ (AUTO) or the downward-blowing position. • When VANE CONTROL button is pressed again, the vane returns to the previously-set position and the air conditioner starts the heating operation in approx. 3 minutes.

NOTE:

- If you make the air flow not to blow directly onto your body by pressing VANE CONTROL button, the compressor stops for 3 minutes even during the operation of the air conditioner.
- The air conditioner operates with decreased air flow until the compressor turns on again.

(10) ECONO COOL () operation (ECONomical operation)

When ECONO COOL button is pressed in COOL mode, set temperature is automatically set 2°C higher.

Also the horizontal vane swings in various cycle according to the temperature of indoor heat exchanger(RT12).

SWING operation makes you feel cooler than set temperature. So, even though the set temperature is higher, the air conditioner can keep comfort. As a result, energy can be saved.

ECONO COOL operation is cancelled when ECONO COOL button is pressed once again or VANE CONTROL button is pressed or change to other operation mode.

<SWING operation>

In swing operation of ECONO COOL operation mode, the initial air flow direction is adjusted to "Horizontal".

According to the temperature of indoor coil thermistor RT12 at starting of this operation, next downward blow time is decided. Then when the downward blow has been finished, next horizontal blow time is decided.

For initial 10 minutes the swing operation is performed in table G~H for quick cooling.

Also, after 10 minutes when the difference of set temperature and room temperature is more than 2°C, the swing operation is performed in table D~H for more cooling.

The air conditioner repeats the swing operation in various cycle as follows.

	Temperature of indoor coil thermistor RT12	Downward blow time (second)	Horizontal blow time (second)
A	15°C or less	2	23
B	15°C to 17°C	5	20
C	17°C to 18°C	8	17
D	18°C to 20°C	11	14
E	20°C to 21°C	14	11
F	21°C to 22°C	17	8
G	22°C to 24°C	20	5
H	more than 24°C	23	2

6-8. TIMER OPERATION

1. How to set the timer

(1) Press OPERATE/STOP (ON/OFF) button to start the air conditioner.

(2) Check that the current time is set correctly.



NOTE : Timer operation will not work without setting the current time. Initially "AM0:00" blinks at the current time display of TIME MONITOR, so set the current time correctly with CLOCK SET button.

ON timer setting

(1) Press ON-TIMER button () to set ON timer.

Each time the button is pressed, ON timer mode alternates between ON and OFF.

(2) Set the time of the timer using TIME SET buttons ( and ).



Each time FORWARD button () is pressed, the set time increases by 10 minutes; each time BACKWARD button () is pressed, the set time decreases by 10 minutes.

OFF timer setting

(1) Press OFF-TIMER button () to set OFF timer.

Each time the button is pressed, OFF timer mode alternates between ON and OFF.

(2) Set the time of the timer using TIME SET buttons ( and ).

Each time FORWARD button () is pressed, the set time increases by 10 minutes; each time BACKWARD () button is pressed, the set time decreases by 10 minutes.

2. Cancel

TIMER setting can be cancelled with ON/OFF TIMER buttons.

To cancel ON timer, press ON-TIMER button ().

To cancel OFF timer, press OFF-TIMER button ().

TIMER is cancelled and the display of set time disappears.

PROGRAM TIMER

- OFF timer and ON timer can be used in combination. The timer of the set time that is reached first will operate first.
- “↑” and “↓” display shows the order of OFF timer and ON timer operation.

(Example 1) The current time is 8:00 PM.
The unit turns off at 11:00 PM, and on at 6:00 AM.

(Example 2) The current time is 11:00 AM.
The unit turns on at 5:00 PM, and off at 9:00 PM.

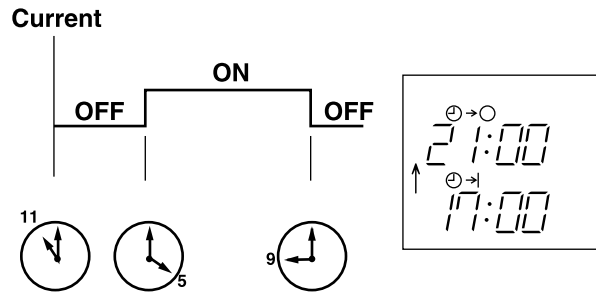
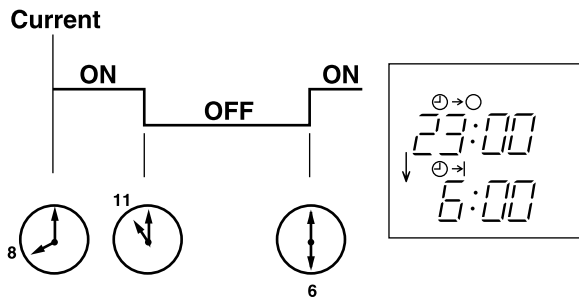

NOTE : If the main power is turned off or a power failure occurs while AUTO START/STOP timer is active, the timer setting is cancelled. As these models are equipped with an auto restart function, the air conditioner starts operating with timer cancelled when power is restored.

6-9. EMERGENCY/TEST OPERATION

In case of test run operation or emergency operation, use EMERGENCY OPERATION switch on the front of the indoor unit. Emergency operation is available when the remote controller is missing, has failed or the batteries of the remote controller run down. The unit will start and AREA lamp will light.

The first 30 minutes of operation is the test run operation. This operation is for servicing. The Indoor fan speed runs at High speed and the system is in continuous operation (The thermostat in ON).

After 30 minutes of test run operation, the system shifts to EMERGENCY COOL / HEAT MODE with a set temperature of 24°C. The fan speed shifts to Med..

The coil frost prevention works even in emergency operation, and defrosting too.

In the test run or emergency operation, the horizontal vane operates in VANE AUTO (@) mode.

Emergency operation continues until EMERGENCY OPERATION switch is pressed once or twice or the unit receives any signal from the remote controller. In case of latter, normal operation will start.

NOTE : Do not press EMERGENCY OPERATION switch during normal operation.

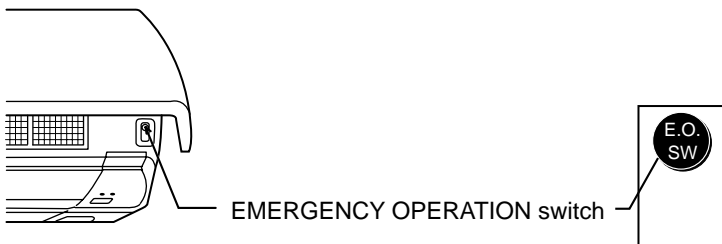

Operation mode	COOL	HEAT
Set temperature	24°C	24°C
Fan speed	Medium	Medium
Horizontal vane	Auto	Auto

The operation mode is indicated by the Operation Indicator lamp on the indoor unit as following

Operation indicator lamp

Press once <Cool>



Lighted



Not lighted

Press again <Heat>

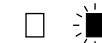

Press once again <Stop>



6-10. INVERTER SYSTEM CONTROL

6-10-1. Inverter main power supply circuit

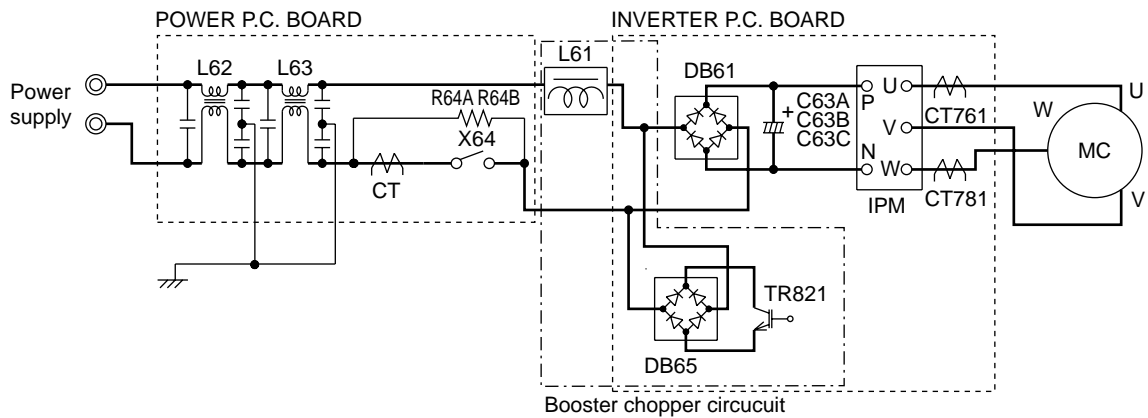

Function of main parts

SYMBOL	NAME	FUNCTION	
IPM	INTELLIGENT POWER MODULE	It supplies three-phase AC power to compressor.	
C63A/C63B/C63C	SMOOTHING CAPACITOR	It stabilizes the DC voltage.	
CT761/CT781	CURRENT TRANSFORMER	It measures the current of the compressor motor.	
CT	CURRENT TRANSFORMER	It measures the value of current which is supplied to the main power supply circuit.	
DB61	DIODE MODULE	It converts the AC voltage to DC voltage.	
R64A, R64B	CURRENT-LIMITING RESISTOR	It absorbs the rush current not to run into the main power supply circuit when the electricity turns ON.	
X64	RELAY	It short-circuits the resistance which restricts rush current during the normal operation after the compressor startup.	
DB65	DIODE MODULE	Booster chopper circuit	It improves power factor. It rectifies AC and controls its voltage.
TR821	SWITCHING POWER TRANSISTOR		
L61	REACTOR		

6-10-2. Outline of main power supply circuit

1. At the start of operation

Main power supply circuit is formed when X64 (Relay) is turned ON at compressor startup.

To prevent rush current from running into the circuit when power supply is turned ON, R64A and R64B (Current-limiting resistor) are placed in sub circuit.

2. At normal operation

- ① When AC runs into POWER P.C. board, its external noise is eliminated in the noise filter circuit.
- ② After noise is eliminated from AC, it is rectified to DC by DB61 (Diode module).
- ③ DC voltage, to which AC has been rectified by process ②, is stabilized by C63A, C63B and C63C (Smoothing capacitor) and supplied to IPM (Intelligent power module).
- ④ DC voltage, which has been stabilized in process ③, is converted to three-phase AC by IPM and supplied to compressor.
- ⑤ CT761 and CT781 (Current Transformer), which are placed in the power supply circuit to compressor, are used to measure the value of phase current and locate the polar direction of rotor with algorithm. PWM (Pulse width modulation) controls impressed voltage and frequency with those information.

3. Purpose of PAM adoption

PAM : Pulse Amplitude Modulation

PAM has been adopted for the efficiency improvement and the adaptation to IEC harmonic current emission standard.

Outline of simple partial switching method

In conventional inverter models, diode module rectifies AC voltage to DC voltage, smoothing capacitor makes its DC waveform smooth, and IPM converts its DC voltage to imitated AC voltage again in order to drive the compressor motor.

However, it has been difficult to meet IEC harmonic current emission standard by above circuit because harmonic gets generated in the input current waveform and power factor gets down. The simple partial switching method with PAM, which has been adopted this time, places and utilizes the booster chopper circuit (L61, DB65 and TR821) before rectifying AC voltage in the general passive-method converter circuit. As harmonic gets suppressed and the peak of waveform gets lower by adding booster chopper circuit as mentioned above and by synchronizing the timing of one-time switching with the zero-cross point of waveform, the input current waveform can be improved and the requirement of IEC harmonic current emission standard can be satisfied. Since the switching times is just once by synchronizing with the zero cross point, this simple partial switching method has the feature of lower energy loss compared to active filter method. In addition, output and efficiency is enhanced by combining with vector-controlled inverter in order to boost the voltage of power supplied to IPM.

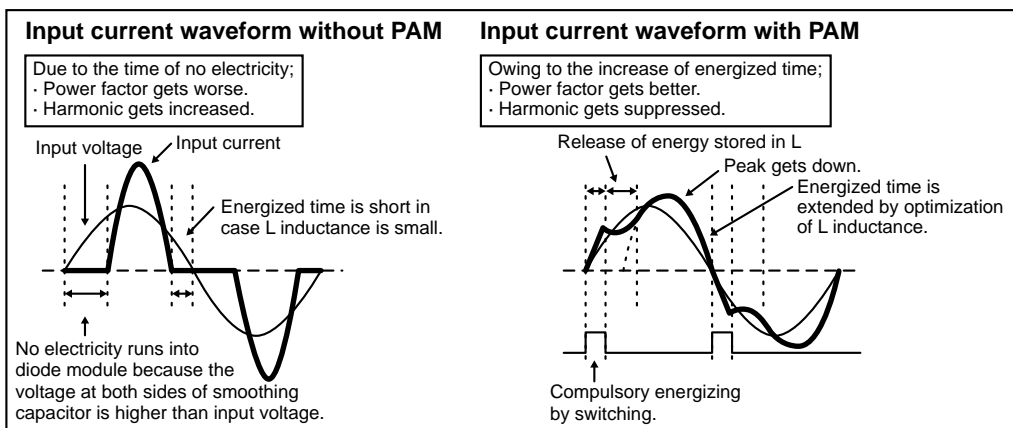

4. Intelligent power module

IPM consists of the following components

- IGBT (x6) : Converts DC waveform to three-phase AC waveform and outputs it.
- Drive Circuit : Drives transistors.
- Protection circuit : Protects transistors from overcurrent.

Since the above components are all integrated in IPM, IPM has a merit to make the control circuit simplify and miniaturize.

5. Smoothing capacitor

C63A, C63B and C63C stabilize the DC voltage and supply it to IPM.

6. Elimination of electrical noise

Noise filter circuit, which is formed by *CMC COILS capacitors placed on the POWER P.C. board, eliminates electrical noise of AC power that is supplied to main power supply circuit. And this circuit prevents the electrical noise generated in the inverter circuit from leaking out.

*CMC COILS; Common mode choke coils

Sine wave control

In these air conditioners, compressor equips brushless DC motor which doesn't have Hall element.

In short, the motor is sensorless. However, it's necessary to locate the polar direction of rotor in order to drive brushless DC motor efficiently. The general detection method of the polar direction for such a DC motor is to locate it from the voltage induced by unenergized stator.

Therefore, It is necessary to have a certain period of time in which the stator is being unenergized for the rotor position detection when the voltage of supplied power is impressed.

So the motor has been driven by square wave control (the conventional motor drive system) which energizes the motor only when the range of electrical angle is within 120° because it is forced to be unenergized within 30° at start & end of one heap in one waveform cycle (180°) when the voltage is impressed.

However, torque pulsation occurs at rotation in this method when the current-carrying phases are switched over to other phases in sequence. Therefore, sine wave control system is adopted for these air conditioners because it can make the phase-to-phase current waveform smoother (sine wave) in order to drive the motor more efficiently and smoothly.

6-10-3. Characteristics of sine wave control in case of brushless DC motor

- Although ordinary three-phase induction motor requires energy to excite the magnetic field of rotor, brushless DC motor doesn't need it. So, higher efficiency and torque are provided.
- This control provides the most efficient waveform corresponding to the rotation times of compressor motor.
- The rotation can be set to higher compared to the conventional motor drive system. So, the time in which air conditioner can be operated with energy saved is longer than conventional models. This can save annual electric consumption.
- Compared to square wave control, the torque pulsation is reduced at rotation so that the motor operates more quietly.
- Since response and efficiency of motor are enhanced in sine wave control, finer adjustment can be provided.

	DC Motor	AC Motor
Rotor	Permanent magnet is embedded.	Excited by magnetic field of stator
Rotor Position Signal	Necessary	Unnecessary

※ In brushless DC motor, permanent magnet is embedded in the rotor. Therefore, it doesn't require energy to excite the rotor like AC motor does. However, it's necessary to control the frequency of three-phase AC current supplied to the stator according to the polar direction of magnet embedded in the rotor so as to drive the motor efficiently. Controlling three-phase AC current frequency also means controlling the timing to switch the polarity of stator. Therefore, the polar direction of rotor needs to be detected.

6-10-4. Control Method of Rotation Times

Sine wave control makes the current transformers conduct real time detection of the value of the current running into the motor, locates the rotor position from the detected value, and decides if voltage should be impressed and if frequency should be changed.

Compared to the conventional control and rotor position detection method, sine wave control can provide finer adjustment of the voltage of supplied power. The value of the current running into the motor is determined by each motor characteristic.

6-11. OPERATIONAL FREQUENCY CONTROL OF OUTDOOR UNIT

1. Outline

The operational frequency is as following:

First, the target operational frequency is set based on the difference between the room temperature and the set temperature.

Second, the target operational frequency is regulated by discharge temperature protection, high pressure protection, electric current protection and overload protection and also by the maximum/minimum frequency.

2. Maximum/minimum frequency in each operation mode

Applied model	COOL			HEAT			DRY	
	Minimum frequency	Rated frequency	Maximum frequency	Minimum frequency	Rated frequency	Maximum frequency	Minimum frequency	Maximum frequency
MUZ-GA25VA MUZ-GA25VAH	28	65	70	48	85	105	28	40
MUZ-GA35VA MUZ-GA35VAH	28	88	98	45	96	105	28	58

※ The operation frequency in COOL mode is restricted the upper limit frequency after 1 hour as shown below for dew prevention.

It is rated frequency or less.

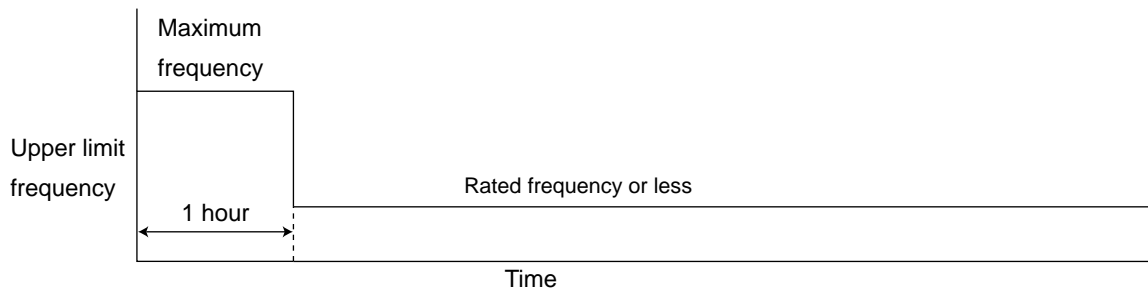

6-12. EXPANSION VALVE CONTROL (LEV CONTROL) MUZ-GA35

(1) Outline of LEV control

The LEV basic control is comprised of setting LEV opening degree to the standard opening degrees set for each operational frequency of the compressor. However, when any change in indoor/outdoor temperatures or other factors cause air conditioning load fluctuation, the LEV control also works to correct LEV opening degree based on discharge temperature (Shell temperature) of the compressor, developing the unit's performance.

standard specification	Control range	from minimum 33 pulse to maximum 500 pulse.
	Actuating speed	LEV opens 40 pulse/second and close 90 pulse/second
	Opening degree adjustment	LEV opening degree is always adjusted in opening direction. (When reducing the opening degree, LEV is once over-closed, and then adjusted to the proper degree by opening.
general operation	Unit OFF	LEV remains at maximum opening degree (reaches maximum opening degree approximate in 15 minutes after compressor stops)
	Remote controller ON	LEV is positioned. (first full-closed at zero pulse and then positioned.)
	COOL · DRY MODE During 1 to 5 minutes after compressor starts	LEV is fixed to standard opening degree according to operational frequency of compressor.
	HEAT MODE During 1 to 15 minutes after compressor starts	
	More than COOL, DRY: 5/ HEAT: 15 minutes have passed since compressor start-up	LEV opening degree is corrected to get target discharge temperature of compressor. (For discharge temperature lower than target temperature, LEV is corrected in closing direction.) (For discharge temperature higher than target temperature, LEV is corrected in opening direction.) ※It may take more than 30 minutes to reach target temperature, depending on operating conditions.
	Thermostat OFF	LEV is adjusted to exclusive opening degree for thermostat OFF.
	Thermostat ON	LEV is controlled in the same way as that after the compressor has started up.
Defrosting in HEAT mode	LEV is adjusted to open 500 pulse.	

(2) Time chart

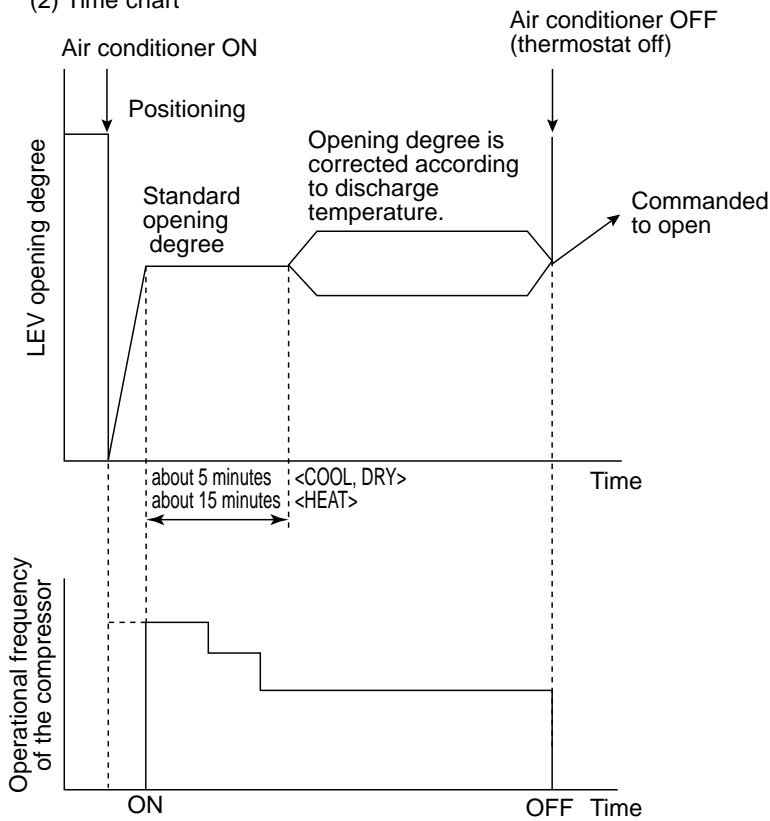

(3) Control data

(a) Reference value of target discharge temperature (COOL/HEAT °C)

Applied model	A	B	C	D	E	F
MUZ-GA35VA	47/41	53/48	58/55	63/60	67/65	67/65
MUZ-GA35VAH	47/41	53/48	58/55	63/60	67/65	67/65

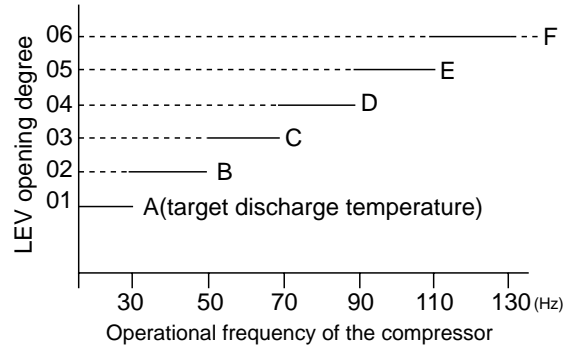

In COOL operation, the two indoor coil thermistors (one main and one sub) sense temperature ununiformity (super heat) at the heat exchanger, and when temperature difference have developed, the indoor coil thermistors adjust LEV opening degree to get approximate 10 degrees lower temperature than the target temperature in the table above, thus diminishing super heat.

(b) Reference value of LEV standard opening degree (COOL/ HEAT pulse)

Applied model	01	02	03	04	05	06
MUZ-GA35VA	150/110	190/110	240/150	280/170	310/200	340/230
MUZ-GA35VAH	150/110	190/110	240/150	280/170	310/200	340/230

**MSZ-GA50VA MUZ-GA50VA
MSZ-GA60VA MUZ-GA60VA
MSZ-GA71VA MUZ-GA71VA**

WIRELESS REMOTE CONTROLLER

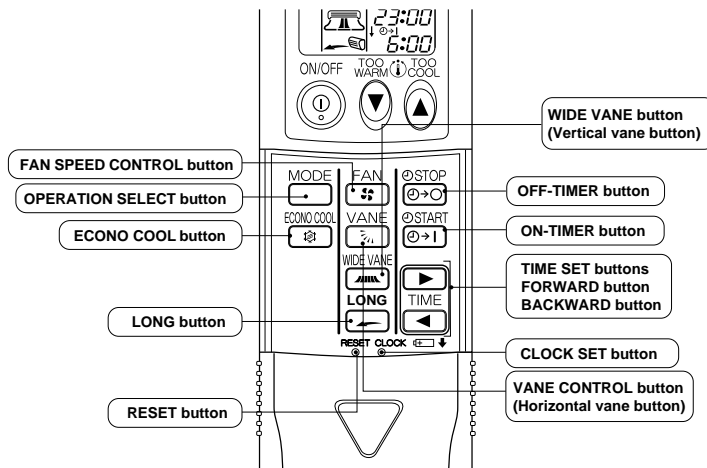
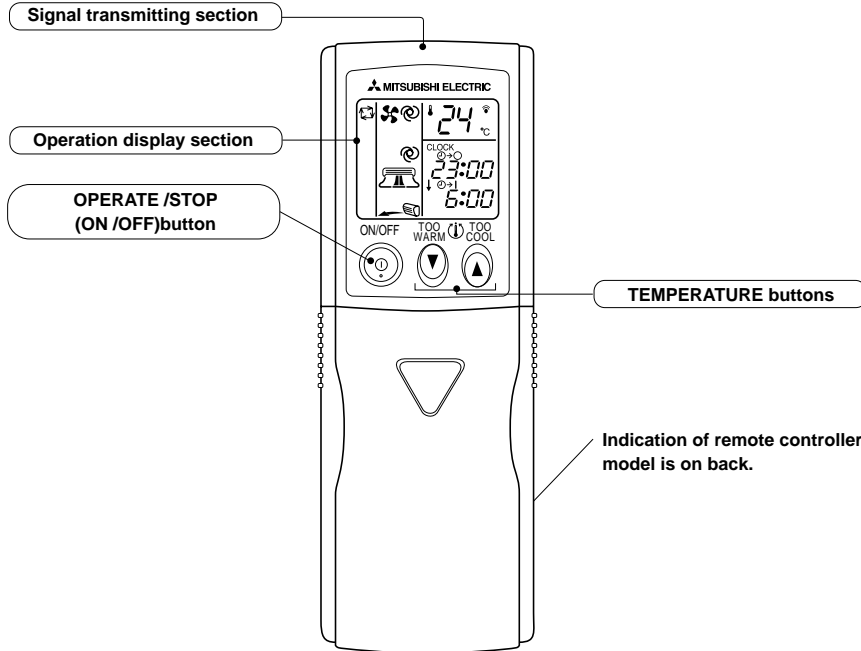

Once the operation mode is set, the same operation mode can be repeated by simply turning OPERATE/STOP (ON/OFF) button ON.

Indoor unit receives the signal with a beep tone.

When the system turns off, 3-minute time delay will operate to protect system from overload and compressor will not restart for 3 minutes.

6-13. COOL () OPERATION

- (1) Press OPERATE/STOP(ON/OFF) button.
OPERATION INDICATOR lamp of the indoor unit turns on with a beep tone.
- (2) Select COOL mode with OPERATION SELECT button.
- (3) Press TEMPERATURE buttons (TOO WARM or TOO COOL button)to select the desired temperature.
The setting range is 16 ~ 31°C

1. Thermostat control

Thermostat is ON or OFF by difference between room temperature and set temperature

Initial temperature difference	Thermostat	Set temperature
Room temperature minus set temperature : -1.0 °C or more.....	ON	
Room temperature minus set temperature : less than -1.0 °C	OFF	

Difference between room temperature and set temperature during operation.

2. Indoor fan speed control

Indoor fan operates continuously at the set speed by FAN SPEED CONTROL button regardless of the thermostat's OFF-ON. In AUTO the fan speed is as follows.

Initial temperature difference	Fan speed	Difference between room temperature and set temperature during operation
Room temperature minus set temperature : 1.7 °C or more	High	
Room temperature minus set temperature : Between 1 and 1.7 °C	Med.	
Room temperature minus set temperature : less than 1 °C	Low	

3. Coil frost prevention

Temperature control

When indoor coil thermistor detects following temperature for 90 seconds, operational frequency of compressor is controlled according to the following table.

Temperature of indoor coil thermistor	Operation frequency
10°C or more	Normal (variable)
8°C to 10°C	Raise 6Hz
6°C to 8°C	Fixed
3°C to 6°C	Lower 3Hz
3°C or less	Lower 6Hz Compressor is turned OFF for 5 minutes when temperature of indoor coil thermistor continues 3°C or less for 5 minutes or more.

The indoor fan maintains the actual speed of the moment.

4. Low outside temperature operation

If the outside temperature falls to 18°C or less during operation in COOL mode, the unit enters the low outside temperature operation mode.

<Operation>

- (1) If the unit enters the low outside temperature operation mode, the outside fan rotation speed gets slow down.
- (2) Even when the unit is in the "thermostat-off" status under the low outside temperature operation mode, the outside fan rotation does not stop.
- (3) Outside temperature detecting control
In this mode to detect the exact outside temperature the compressor turns OFF with the outdoor fan ON for 3 minutes once 1 hour; if the outside temperature rises over 18°C, the unit goes back to the normal COOL mode, and if the outside temperature is still 18°C or less, the unit stays in the low outside temperature operation mode.
- (4) Dew drop prevention
When the ambient temperature thermistor RT65 reads -12°C or less, as coil frost or dew drop from indoor unit may occur, the compressor turns OFF with the outdoor fan ON for prevention of them.

※Other protections work as well as in the normal COOL mode.

6-14. DRY (Δ) OPERATION

- (1) Press OPERATE/STOP(ON/OFF) button.
OPERATION INDICATOR lamp of the indoor unit turns on with a beep tone.
- (2) Select DRY mode with OPERATION SELECT button.
- (3) The microprocessor reads the room temperature and determines the set temperature. Set temperature is as shown on the right chart.

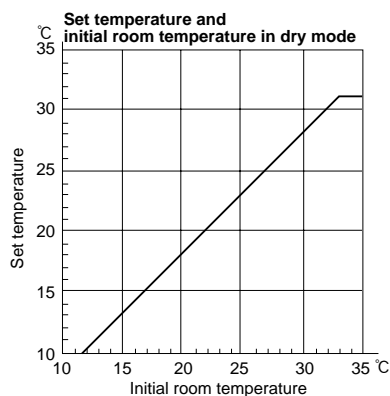

The system for dry operation uses the same refrigerant circuit as the cooling circuit.

The compressor and the indoor fan are controlled by the room temperature.

By such controls, indoor flow amounts will be reduced in order to lower humidity without much room temperature decrease.

1. Thermostat control

Thermostat is ON or OFF by difference between room temperature and set temperature.

Initial temperature difference	Thermostat	Set temperature
Room temperature minus set temperature : $-1.0\text{ }^{\circ}\text{C}$ or more	ON	
Room temperature minus set temperature : less than $-1.0\text{ }^{\circ}\text{C}$	OFF	

2. Indoor fan speed control

Indoor fan operates at the set speed by FAN SPEED CONTROL button.
When thermostat OFF (compressor OFF) fan speed becomes Very Low.

Initial temperature difference	Fan speed	Difference between room temperature and set temperature during operation
Room temperature minus set temperature : $1.7\text{ }^{\circ}\text{C}$ or more	High	
Room temperature minus set temperature : Between 1 and $1.7\text{ }^{\circ}\text{C}$	Med.	
Room temperature minus set temperature : less than $1\text{ }^{\circ}\text{C}$	Low	

3. Coil frost prevention

Coil frost prevention is as same as COOL mode. (6-13.3.)

The indoor fan maintains the actual speed of the moment. However, when coil frost prevention works while the compressor is not operating it's speed becomes the set speed.

4. Low outside temperature operation

Low outside temperature operation is as same as COOL mode. (6-13.4.)

6-15. HEAT () OPERATION

(1) Press OPERATE/STOP(ON/OFF) button.

OPERATION INDICATOR lamp of the indoor unit turns on with a beep tone.

(2) Select HEAT mode with OPERATION SELECT button.

(3) Press TEMPERATURE buttons (TOO WARM or TOO COOL button) to select the desired temperature.

The setting range is $16\text{ }^{\circ}\text{C}$ ~ $31\text{ }^{\circ}\text{C}$.

1. Thermostat control

Thermostat is ON or OFF by difference between room temperature and set temperature.

Initial temperature difference	Thermostat	Set temperature
Room temperature minus set temperature : less than $2.0\text{ }^{\circ}\text{C}$	ON	
Room temperature minus set temperature : $2.0\text{ }^{\circ}\text{C}$ or more	OFF	

2. Indoor fan speed control

(1) Indoor fan operates at the set speed by FAN SPEED CONTROL button.

In Auto the fan speed is as follows.

Initial temperature difference	Fan speed	Difference between room temperature and set temperature during operation
Set temperature minus room temperature: $2\text{ }^{\circ}\text{C}$ or more	High	
Set temperature minus room temperature: Between 1 and $2\text{ }^{\circ}\text{C}$	Med.	
Set temperature minus room temperature: less than $1\text{ }^{\circ}\text{C}$	Low	

(2) Cold air prevention control

① When the compressor is not operating,

(I) if the temperature of room temperature thermistor RT11 is $15\text{ }^{\circ}\text{C}$ or less, or RT12 is less than $18\text{ }^{\circ}\text{C}$, the fan stops.

(II) if the temperature of room temperature thermistor RT11 is more than $15\text{ }^{\circ}\text{C}$, or RT12 is more than $18\text{ }^{\circ}\text{C}$, the fan operates at Very Low.

② When the compressor is operating,

(I) if the temperature of RT12 is $18\text{ }^{\circ}\text{C}$ or more, the fan operates at set speed.

(II) if the temperature of RT12 is less than $18\text{ }^{\circ}\text{C}$ and

(i) if heating operation starts after defrosting, the fan stops.

(ii) if the temperature of room temperature thermistor RT11 is $15\text{ }^{\circ}\text{C}$ or less, the fan stops.

(iii) if the temperature of room temperature thermistor RT11 is more than $15\text{ }^{\circ}\text{C}$, the fan operates at Very Low.

NOTE : When 3 minutes have passed since the compressor started operation, this control is released regardless of the temperature of RT11 and RT12.

3. High pressure protection

In HEAT operation the indoor coil thermistor detects the temperature of the indoor heat exchanger. The compressor operational frequency is controlled to prevent the condensing pressure from increasing excessively.

4. Overload starting

When the room temperature thermistor RT11 reads 18°C or more, the compressor runs with its maximum frequency regulated for 10 minutes after the start-up.

5. Defrosting

(1) Starting conditions of defrosting

When the following conditions a) ~ c) are satisfied, the defrosting starts.

a) The defrost thermistor reads -3°C or less.

b) The cumulative operation time of the compressor has reached any of the set values* (31, 35, 45, 55, 65, 75, 85, 95, 105, 115, 150 minutes).

c) More than 5 minutes have passed since the start-up of the compressor.

* Set value of compressor operation time (hereinafter referred to as defrost interval)

This is decided by the temperature of defrost thermistor and ambient temperature thermistor, the previous defrosting time. For example, the first defrost interval is 40 minutes long, and the second is 45 minutes long. The third and subsequent intervals are set to be longer, and less frequent, depending on defrosting time.

The third and subsequent defrost intervals follow any of the three patterns ...5 or 10 to 20 minutes longer, the same, or 5 or 10 to 20 minutes shorter compared with the previous defrost interval ... with the longest 125 minutes and the shortest 40 minutes.

(2) Releasing conditions of defrosting

Defrosting is released when any of the following conditions is satisfied:

a) The defrost thermistor continues to read 15°C or more for 30 seconds.

b) Defrosting time has exceeded 10 minutes.

c) Any other mode than HEAT mode is set during defrosting.

Time chart of defrosting in HEAT mode (reverse type)

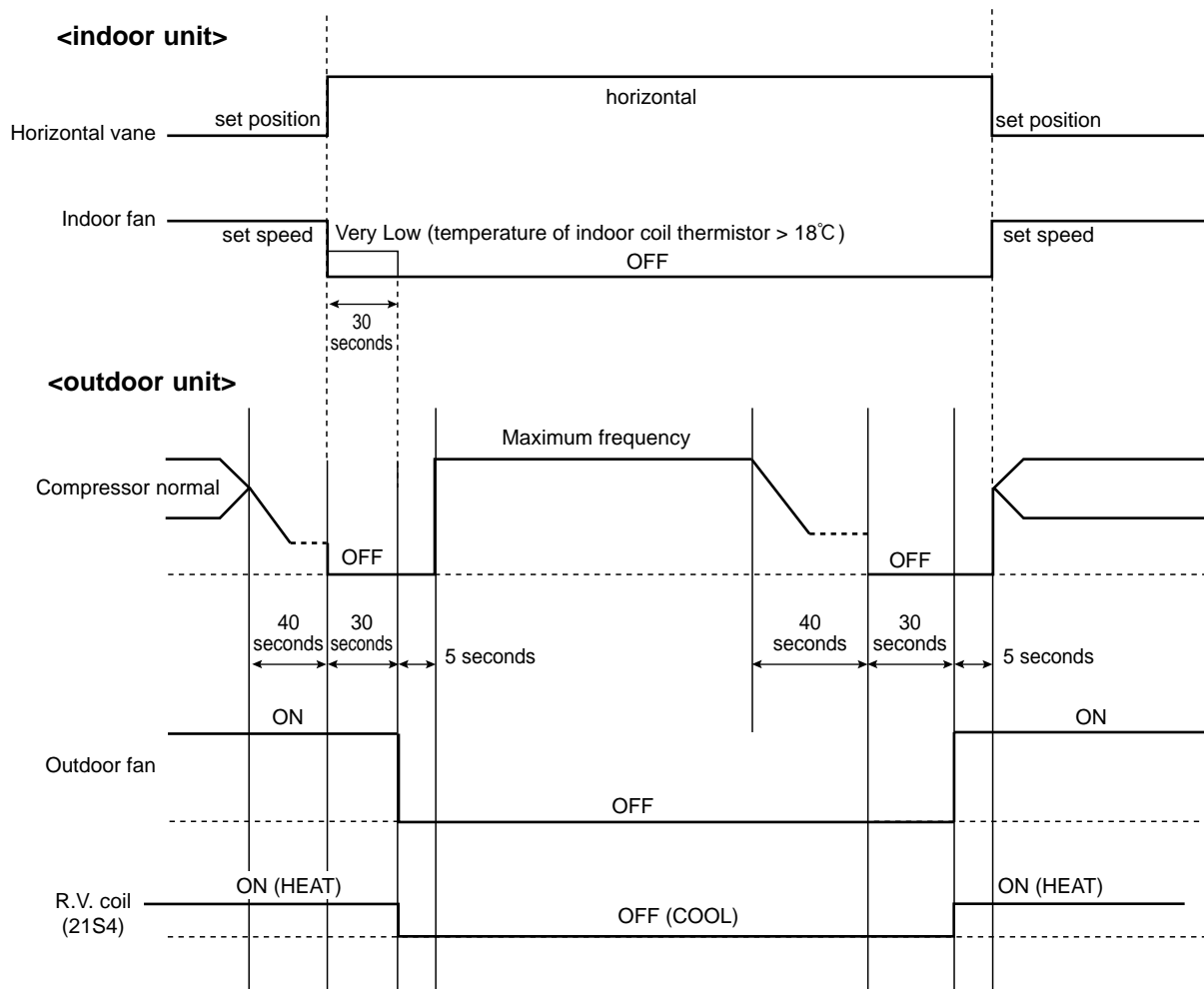

6-16. AUTO CHANGE OVER ... AUTO MODE OPERATION

Once desired temperature is set, unit operation is switched automatically between COOL and HEAT operation.

1. Mode selection

(1) Initial mode

At first indoor unit operates only indoor fan with outdoor unit OFF for 3 minutes to detect present room temperature. Following the conditions below, operation mode is selected.

- ① If the room temperature thermistor RT11 reads more than set temperature, COOL mode is selected.
- ② If the room temperature thermistor RT11 reads set temperature or less, HEAT mode is selected.

(2) Mode change

In case of the following conditions the operation mode is changed.

- ① COOL mode changes to HEAT mode when 15 minutes have passed with the room temperature 2 degrees below the set temperature.
- ② HEAT mode changes to COOL mode when 15 minutes have passed with the room temperature 2 degrees above the set temperature.

In the other cases than the above conditions, the present operation mode is continued.

NOTE1: Mode selection is performed when multi standby (refer to NOTE2) is released and the unit starts operation with ON-timer.

NOTE2: If two or more indoor units are operating in multi system, there might be a case that the indoor unit, which is operating in AUTO (□), cannot change over the other operating mode (COOL ↔ HEAT) and becomes a state of standby.

(3) Indoor fan control/ Vane control

As the indoor fan speed and the horizontal vane position depend on the selected operation mode, when the operation mode changes over, they change to the exclusive ones.

6-17. INDOOR FAN MOTOR CONTROL

(1) Rotational frequency feedback control

The indoor fan motor is equipped with a rotational frequency sensor, and outputs signal to the microprocessor to feedback the rotational frequency. Comparing the current rotational frequency with the target rotational frequency (High, Med., Low), the microprocessor adjusts fan motor electric current to make the current rotational frequency close to the target rotational frequency. With this control, when the fan speed is switched, the rotational frequency changes smoothly.

Rotational frequency

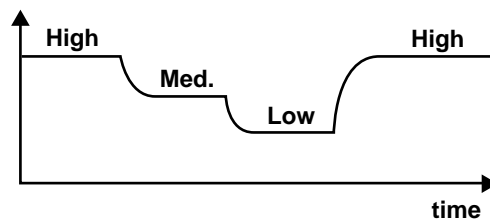

(2) Fan motor lock-up protection

When the rotational frequency feedback signal has not output for 12 seconds, (or when the microprocessor cannot detect the signal for 12 seconds) energizing to the fan motor is stopped. Then the microprocessor retries detection 3 times every 30 seconds. If the microprocessor still cannot detect the signal, the fan motor is regarded locked-up. When the fan motor lock-up, POWER lamp flashes on and off to show the fan motor abnormality.

6-18. OUTDOOR FAN MOTOR CONTROL

Fan speed is switched according to the compressor frequency.

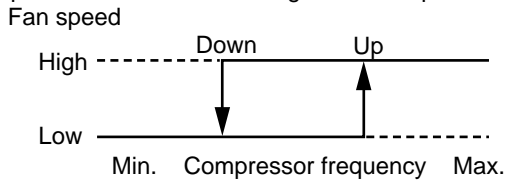

<Relation between compressor frequency and fan speed>

Mode	Fan speed	Compressor frequency	
		MUZ-GA50/GA60	MUZ-GA71
COOL	Up	44Hz	54Hz
	Down	33Hz	39Hz
HEAT	Up	44Hz	54Hz
	Down	33Hz	39Hz

6-19. AUTO VANE OPERATION

1. Horizontal vane

(1) Vane motor drive

These models are equipped with a stepping motor for the horizontal vane. The rotating direction, speed, and angle of the motor are controlled by pulse signals (approx. 12V) transmitted from indoor microprocessor.

(2) The horizontal vane angle and mode changes as follows by pressing VANE CONTROL button.

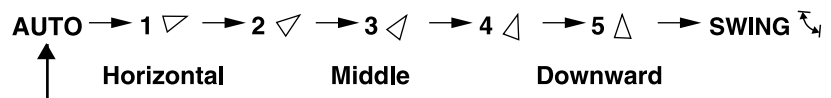

(3) Positioning

The vane presses the vane stopper once to confirm the standard position and then moves to the set angle. Confirming of standard position is performed in case of follows.

- When the power supply turns ON.
- When the operation starts or finishes (including timer operation).
- When the test run starts.
- When multi-standby starts or finishes.

(4) VANE AUTO (Ⓢ) mode

The microprocessor automatically determines the horizontal vane angle and operation to make the optimum room temperature distribution.

COOL and DRY operation

Vane angle is fixed to Angle 1.

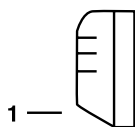

HEAT operation

Vane angle is fixed to Angle 4.

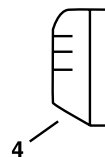

(5) STOP (operation OFF) and ON-TIMER standby

When the following cases occur, the horizontal vane returns to the closed position.

- When OPERATE/STOP (ON/OFF) button is pressed (POWER OFF).
- When the operation is stopped by the emergency operation.
- When ON-TIMER is ON standby.

(6) Dew prevention

During COOL or DRY operation with the vane angle at Angle 4 or 5 when the compressor cumulative operation time exceeds 1 hour, the vane angle automatically changes to Angle 1 for dew prevention.

(7) SWING MODE (風)

By selecting SWING mode with VANE CONTROL button, the horizontal vane swings vertically. The remote controller displays “ 風 ”. SWING mode is cancelled when VANE CONTROL button is pressed once again.

(8) Cold air prevention in HEAT operation

When any of the following conditions occurs in HEAT operation, the vane angle changes to Horizontal position automatically to prevent cold air blowing on users.

- ① Compressor is not operating.
- ② Defrosting is performed.
- ③ Indoor coil thermistor RT12 reads 18°C or below.
- ④ Indoor coil thermistor RT12 temperature is raising from 18°C or below, but it does not exceed 22°C.

Indoor coil thermistor RT12 temperature

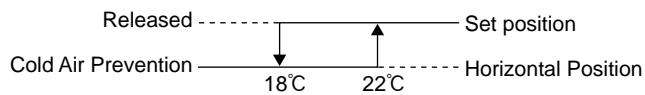

NOTE1: If the temperature of RT12 reads from 18°C to 22°C at the air conditioner starting, this control works.

NOTE2: When 2 or more indoor units are operated with multi outdoor unit, even if any indoor unit turns thermostat off, this control doesn't work in the indoor unit.

(9) ECONO COOL (省) operation (ECONOMical operation)

When ECONO COOL button is pressed in COOL mode, set temperature is automatically set 2°C higher.

Also the horizontal vane swings in various cycle according to the temperature of indoor heat exchanger(RT12).

SWING operation makes you feel cooler than set temperature. So, even though the set temperature is higher, the air conditioner can keep comfort. As a result, energy can be saved.

ECONO COOL operation is cancelled when ECONO COOL button is pressed once again or VANE CONTROL button is pressed or change to other operation mode.

SWING operation

In swing operation of ECONO COOL operation mode, the initial air flow direction is adjusted to “Horizontal”.

According to the temperature of indoor coil thermistor RT12 at starting of this operation, next downward blow time is decided. Then when the downward blow has been finished, next horizontal blow time is decided.

For initial 10 minutes the swing operation is performed in table G~H for quick cooling.

Also, after 10 minutes when the difference of set temperature and room temperature is more than 2°C, the swing operation is performed in table D~H for more cooling.

The air conditioner repeats the swing operation in various cycle as follows.

	Temperature of indoor coil thermistor RT12	Downward blow time (second)	Horizontal blow time (second)
A	15°C or less	2	23
B	15°C to 17°C	5	20
C	17°C to 18°C	8	17
D	18°C to 20°C	11	14
E	20°C to 21°C	14	11
F	21°C to 22°C	17	8
G	22°C to 24°C	20	5
H	more than 24°C	23	2

(10) LONG MODE ()

By pressing LONG button indoor fan speed becomes faster than setting fan speed on the remote controller, and the horizontal vane moves to the position for LONG mode. The remote controller displays “  ”. LONG mode is cancelled when LONG button is pressed once again or VANE button is pressed or ECONO COOL button is pressed in COOL mode.

- In the following example, the vertical vane is set to  (front.).

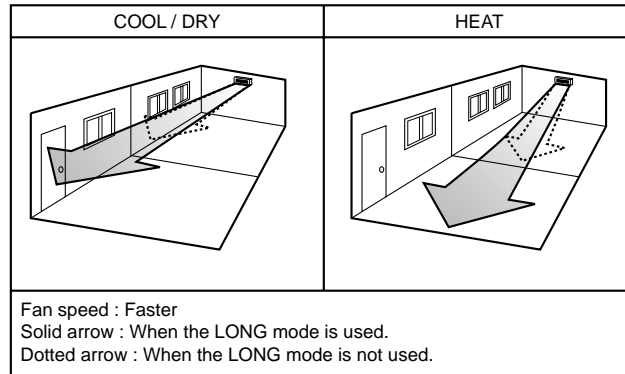

2. Vertical vane

(1) Vane motor drive

These models are equipped with a stepping motor for the vertical vane. The rotating direction, speed, and angle of the motor are controlled by pulse signals (approx. 12V) transmitted from microprocessor.

(2) The vertical vane angle and mode change as follows by pressing WIDE VANE button.

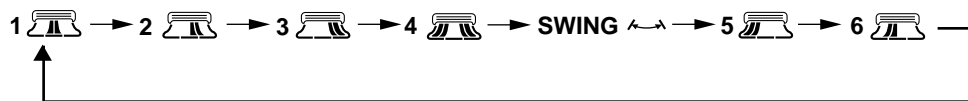

(3) Positioning

The vane is once pressed to the vane stopper to confirm the standard position and then set to the desired angle. Confirming of standard position is performed in case of follows.

- When OPERATE/STOP(ON/OFF) button is pressed (POWER ON/OFF).
- When SWING is started or finished.
- When the power supply turns ON.



(4) SWING MODE ()

By selecting SWING mode with WIDE VANE button, the vertical vane swings horizontally. The remote controller displays “  ”. The vane moves right and left in the width of Angle 4 repeatedly.

(5) WIDE MODE ()

By selecting WIDE mode with WIDE VANE button, indoor fan speed becomes faster than setting fan speed on the remote controller (*). The remote controller displays “  ”.

NOTE : The position of vane angle 3, angle 4 and angle 5 are different in COOL operation and HEAT operation.

- * Indoor fan speed becomes faster than setting fan speed on the remote controller even when  or  is selected.

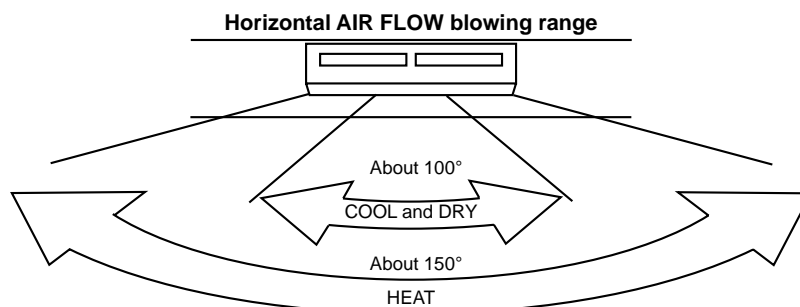











6-20. TIMER OPERATION

1. How to set the timer

- (1) Press OPERATE/STOP (ON/OFF) button to start the air conditioner.
- (2) Check that the current time is set correctly.

NOTE : Timer operation will not work without setting the current time. Initially "AM0:00" blinks at the current time display of TIME MONITOR, so set the current time correctly with CLOCK SET button.

- (3) Press ON-TIMER button() to set ON timer.
Each time the button is pressed, ON timer mode alternates between ON and OFF.
- (4) Set the time of the timer using TIME SET buttons ( and ).
Each time FORWARD button() is pressed, the set time increases by 10 minutes; each time BACKWARD button () is pressed, the set time decreases by 10 minutes.
- (5) Press OFF-TIMER button () to set OFF timer.
Each time the button is pressed, OFF timer mode alternates between ON and OFF.
- (6) Set the time of the timer using TIME SET buttons ( and ).
Each time FORWARD button () is pressed, the set time increases by 10 minutes; each time BACKWARD () button is pressed, the set time decreases by 10 minutes.

2. Cancel

TIMER setting can be cancelled with ON/OFF TIMER buttons.

To cancel ON timer, press ON-TIMER button ().

To cancel OFF timer, press OFF-TIMER button().

TIMER is cancelled and the display of set time disappears.

PROGRAM TIMER

- The OFF timer and ON timer can be used in combination. The timer of the set time that is reached first will operate first.
- "↑" and "↓" display shows the order of the OFF timer and the ON timer operation.

(Example 1) The current time is 8:00 PM.
The unit turns off at 11:00 PM, and on at 6:00 AM.

(Example 2) The current time is 11:00 AM.
The unit turns on at 5:00 PM, and off at 9:00 PM.

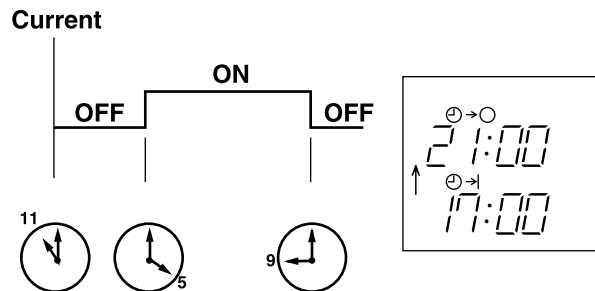
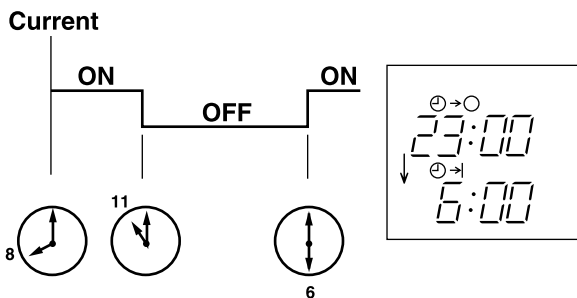

NOTE : If the main power is turned off or a power failure occurs while AUTO START/STOP timer is active, the timer setting is cancelled. As these models are equipped with an auto restart function, the air conditioner starts operating with timer cancelled at the same time that power is restored.

6-21. EMERGENCY / TEST OPERATION

In case of test run operation or emergency operation, use EMERGENCY OPERATION switch on the front of the indoor unit. Emergency operation is available when the remote controller is missing, has failed or the batteries of remote controller run down. The unit will start and OPERATION INDICATOR lamp will light. The first 30 minutes of operation is the test run operation. This operation is for servicing. The indoor fan speed runs at High speed and the system is in continuous operation. (The thermostat is ON.) After 30 minutes of test run operation, the system shifts to EMERGENCY COOL / HEAT MODE with a set temperature of 24°C.

The fan speed shifts to Med. speed.

The coil frost prevention works even in emergency operation, and defrosting too.

In the test run or emergency operation, the horizontal vane operates in VANE AUTO (@) mode.

Emergency operation continues until EMERGENCY OPERATION switch is pressed once or twice or the unit receives any signal from the remote controller. In case of latter, normal operation will start.

NOTE : Do not press EMERGENCY OPERATION switch during normal operation.

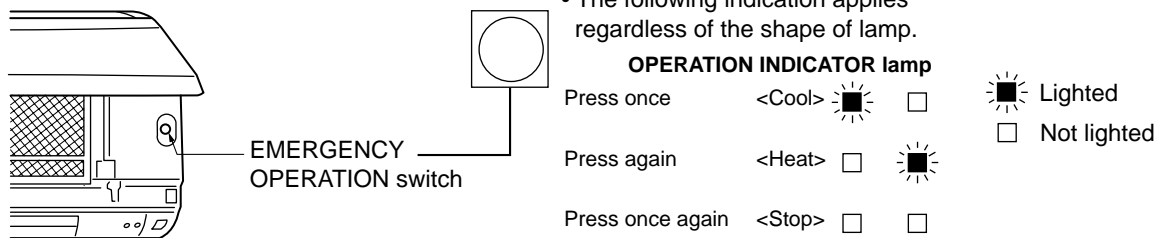

6-22. INVERTER SYSTEM CONTROL

6-22-1. Inverter main power supply circuit

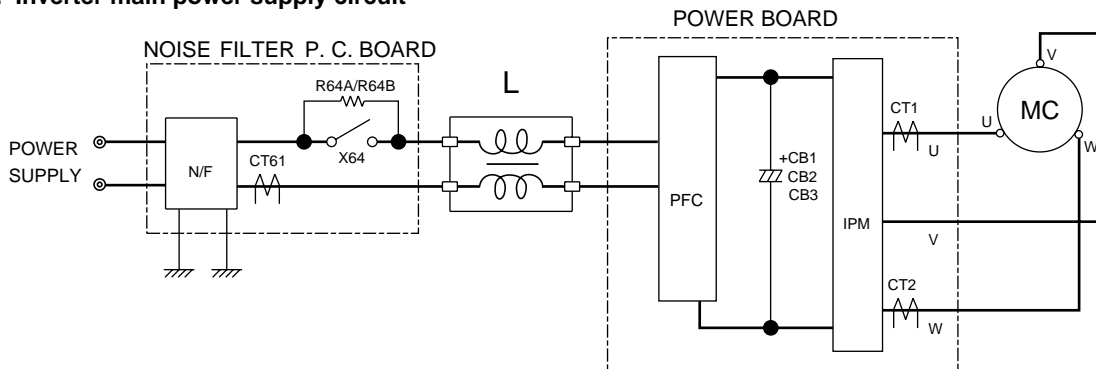

Function of main parts

SYMBOL	NAME	FUNCTION
IPM	INTELLIGENT POWER MODULE	It supplies three-phase AC power to compressor.
CB1~3	SMOOTHING CAPACITOR	It stabilizes the DC voltage.
CT1~2	CURRENT TRANSFORMER	It measures the current of the compressor motor.
CT61	CURRENT TRANSFORMER	It measures the current of the main power supply circuit.
L	REACTOR	It rectifies AC, controls its voltage and improves the power factor of power supply.
PFC	POWER FACTOR CONTROLLER	
R64A, R64B	CURRENT-LIMITING RESISTOR	It restricts rush current with the resistance.
X64	RELAY	It short-circuits the resistance which restricts rush current during the compressor operates.

6-22-2. Outline of main power supply circuit

1. At the start of operation

Main power supply circuit is formed when X64 (Relay) is turned ON at compressor startup.

To prevent rush current from running into the circuit when power supply is turned ON, R64A and R64B (Current-limiting resistor) are placed in sub circuit.

2. At normal operation

① When AC runs into noise filter P.C. board, its external noise is eliminated in the noise filter circuit.

② After noise being eliminated from AC, it is rectified to DC by L (Reactor) and PFC (Power factor controller). If the operating frequency becomes 25Hz or more, DC voltage rises to 370V.

③ DC voltage, to which has AC been rectified by process ②, is stabilized by CB1~3 (Smoothing capacitor) and supplied to IPM (Intelligent power module).

④ The DC (Bus voltage), which has been stabilized in process ③, is converted to three-phase AC by IPM and supplied to compressor.

⑤ CT1 and CT2 (Current Transformer), which are placed in the power supply circuit to compressor, are used to measure the value of phase current and locate the polar direction of rotor with algorithm. PWM (Pulse width modulation) controls impressed voltage and frequency with those information.

3. Power factor improvement

Booster coil L (Reactor) and PFC rectify AC to DC and control its voltage.

In the motor drive system of sine wave control, power factor can be improved by reducing harmonics PFC and L (Reactor) stabilize the voltage of DC supplied to inverter circuit and make its waveform smooth.

4. Power transistor module

IPM consists of the following components.

- Power Transistors (x6): Converts DC waveform to three-phase AC waveform and outputs it.
- Drive Circuit : Drives transistors.
- Protection circuit : Protects transistors from over current.

Since the above components are all integrated in IPM, IPM has a merit that can get the control circuit simplified and miniaturized.

5. Smoothing capacitor

CB1, CB2 and CB3 stabilize the DC voltage and supply it to IPM.

6. Elimination of electrical noise

Noise filter circuit, which is formed by *CMC COILS and capacitors placed on the noise filter P.C. board, eliminates electrical noise of AC power that is supplied to main power supply circuit. In short, common mode noise is absorbed in this circuit.

Moreover, normal mode noise is absorbed in another noise filter circuit which is formed by *NMC COILS and capacitors.

Both noise filter circuit exists for preventing the electrical noise generated in the inverter circuit from leaking out.

*CMC COILS; Common mode choke coils

*NMC COILS; Normal mode choke coils

6-22-3. Sine wave control

In these air conditioners, compressor equips brushless DC motor which doesn't have Hall element.

In short, the motor is sensorless. However, it's necessary to locate the polar direction of rotor in order to drive brushless DC motor efficiently. The general detection method of the polar direction for such a DC motor is to locate it from the voltage induced by unenergized stator.

Therefore, it is necessary to have a certain period of time in which the stator is being unenergized for the rotor position detection when the voltage of supplied power is impressed.

So the motor has been driven by square wave control (the conventional motor drive system) which energizes the motor only when the range of electrical angle is within 120° because it is forced to be unenergized within 30° at start & end of one heap in one waveform cycle (180°) when the voltage is impressed.

However, torque pulsation occurs at rotation in this method when the current-carrying phases are switched over to other phases in sequence. Therefore, sine wave control system is adopted for these air conditioners because it can make the phase-to-phase current waveform smoother (sine wave) in order to drive the motor more efficiently and smoothly.

6-22-4. Characteristics of sine wave control in case of brushless DC motor

- Although ordinary three-phase induction motor requires energy to excite the magnetic field of rotor, brushless DC motor doesn't need it. So, higher efficiency and torque are provided.
- This control provides the most efficient waveform corresponding to the rotation times of compressor motor.
- The rotation can be set to higher compared to the conventional motor drive system. So, the time in which air conditioner can be operated with energy saved is longer than conventional models. This can save annual electric consumption.
- Compared to square wave control, the torque pulsation is reduced at rotation so that the motor operates more quietly.
- Since response and efficiency are enhanced in sine wave control, finer adjustment can be provided.

	DC Motor	AC Motor
Rotor	Permanent magnet is embedded.	Excited by magnetic field of stator
Rotor Position Signal	Necessary	Unnecessary

* In brushless DC motor, permanent magnet is embedded in the rotor. Therefore, it doesn't require energy to excite the rotor like AC motor does. However, it's necessary to control the frequency of three-phase AC current supplied to the stator according to the polar direction of magnet embedded in the rotor so as to drive the motor efficiently. Controlling three-phase AC current frequency also means controlling the timing to switch the polarity of stator. Therefore, the polar direction of rotor needs to be detected.

6-22-5. Control Method of Rotation Times

Sine wave control makes the current transformers conduct real time detection of the value of the current running into the motor, locates the rotor position from the detected value and decides if voltage should be impressed and if frequency should be changed.

Compared to the conventional control and rotor position detection method, sine wave control can provide finer adjustment of the voltage of supplied power. The value of the current running into the motor is determined by each motor characteristic.

6-23. OPERATIONAL FREQUENCY CONTROL OF OUTDOOR UNIT

1. Outline

The operational frequency is as following:

First, the target operational frequency is set based on the difference between the room temperature and the set temperature.

Second, the target operational frequency is regulated by discharge temperature protection, high pressure protection, electric current protection and overload protection and also by the maximum/minimum frequency.

2. Maximum/minimum frequency in each operation mode

Applied model	COOL			HEAT			DRY	
	Minimum frequency	Rated frequency	Maximum frequency	Minimum frequency	Rated frequency	Maximum frequency	Minimum frequency	Maximum frequency
MUZ-GA50VA	20	71	98	30	81	108	20	98
MUZ-GA60VA	20	87	102	30	96	108	20	102
MUZ-GA71VA	20	62	79	20	66	84	20	79

* The operation frequency in COOL mode is restricted the upper limit frequency after 1 hour as shown below for dew prevention.

It is rated frequency or less.

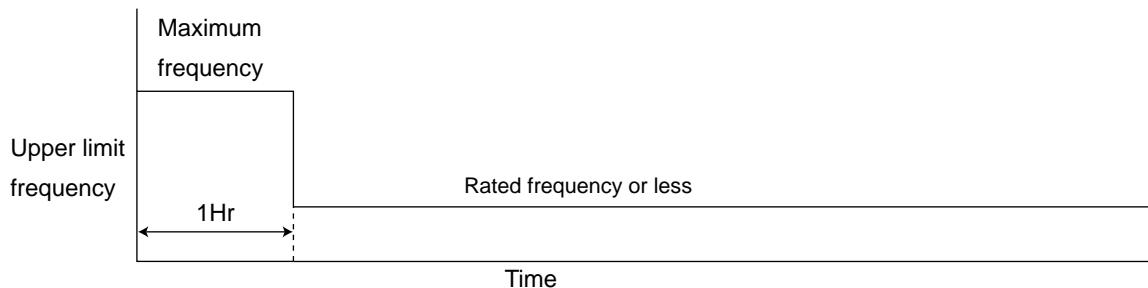

6-24. EXPANSION VALVE CONTROL (LEV CONTROL)

(1) Outline of LEV control

The LEV basic control is comprised of setting LEV opening degree to the standard opening degrees set for each operational frequency of the compressor. However, when any change in indoor/outdoor temperatures or other factors cause air conditioning load fluctuation, the LEV control also works to correct LEV opening degree based on discharge temperature (Shell temperature) of the compressor, developing the unit's performance.

standard specification	Control range	from minimum 59 pulse to maximum 500 pulse.
	Actuating speed	LEV opens 40 pulse/second and close 90 pulse/second
	Opening degree adjustment	LEV opening degree is always adjusted in opening direction. (When reducing the opening degree, LEV is once over-closed, and then adjusted to the proper degree by opening.
general operation	Unit OFF	LEV remains at maximum opening degree (reaches maximum opening degree approximate in 15 minutes after compressor stops)
	Remote controller ON	LEV is positioned. (first full-closed at zero pulse and then positioned.)
	COOL · DRY MODE During 1 to 5 minutes after compressor starts	LEV is fixed to standard opening degree according to operational frequency of compressor.
	HEAT MODE During 1 to 15 minutes after compressor starts	
	More than COOL, DRY: 5/ HEAT: 15 minutes have passed since compressor start-up	LEV opening degree is corrected to get target discharge temperature of compressor. (For discharge temperature lower than target temperature, LEV is corrected in closing direction.) (For discharge temperature higher than target temperature, LEV is corrected in opening direction.) ※It may take more than 30 minutes to reach target temperature, depending on operating conditions.
	Thermostat OFF	LEV is adjusted to exclusive opening degree for thermostat OFF.
	Thermostat ON	LEV is controlled in the same way as that after the compressor has started up.
Defrosting in HEAT mode	LEV is adjusted to open 500 pulse.	

(2) Time chart

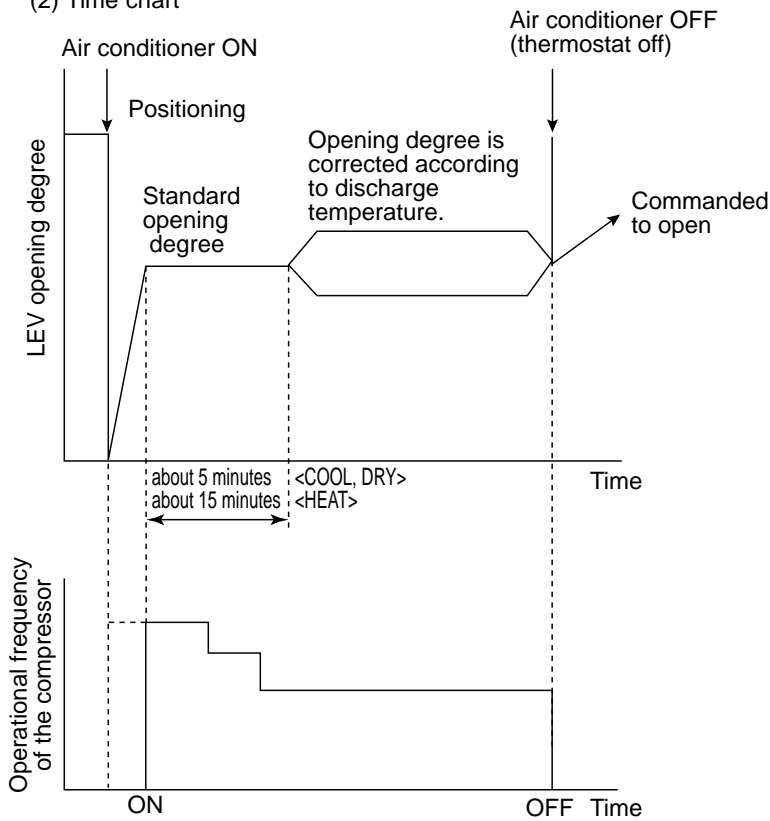

(3) Control data

(a) Reference value of target discharge temperature (COOL/HEAT °C)

Applied model	A	B	C	D	E	F
MUZ-GA50VA	60/60	60/63	60/65	63/67	66/70	67/70
MUZ-GA60VA	60/60	60/63	60/65	63/67	64/70	67/70
MUZ-GA71VA	62/60	62/65	64/67	68/72	74/80	82/85

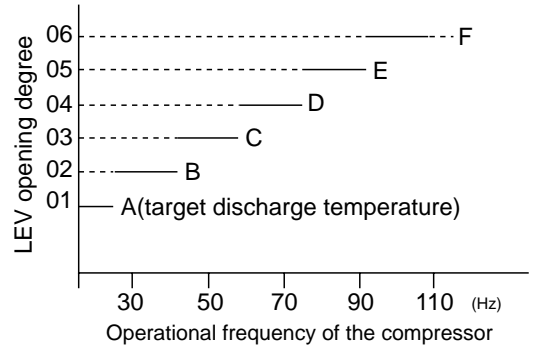

In COOL operation, the two indoor coil thermistors (one main and one sub) sense temperature ununiformity (super heat) at the heat exchanger, and when temperature difference have developed, the indoor coil thermistors adjust LEV opening degree to get approximate 10 degrees lower temperature than the target temperature in the table above, thus diminishing super heat.

(b) Reference value of LEV standard opening degree (COOL/ HEAT pulse)

Applied model	01	02	03	04	05	06
MUZ-GA50VA	150/130	166/150	186/170	206/196	230/210	260/226
MUZ-GA60VA	150/130	166/150	186/170	206/196	230/210	260/226
MUZ-GA71VA	170/140	200/160	240/200	270/220	280/230	290/250

MCF-GA35VB MUCF-GA35VB
 MCF-GA50VB MUCF-GA50VB
 MCF-GA60VB MUCF-GA60VB

WIRELESS REMOTE CONTROLLER

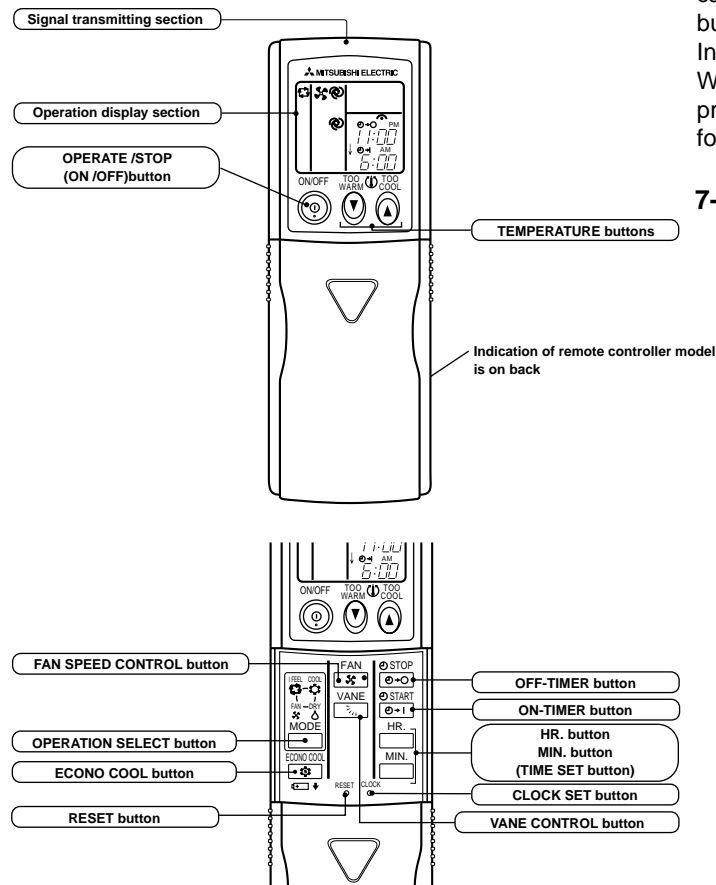

Once the operation mode is set, the same operation mode can be repeated by simply turning OPERATE/STOP (ON/OFF) button ON.

Indoor unit receives the signal with a beep tone.

When the system turns off, 3-minute time delay will operate to protect system from overload and compressor will not restart for 3 minutes.

7-1. "I FEEL CONTROL" (☐) OPERATION

- (1) Press OPERATE/STOP (ON/OFF) button on the remote controller. OPERATION INDICATOR lamp of the indoor unit will turn on with a beep tone.
- (2) Select "I FEEL CONTROL" (☐) mode with OPERATION SELECT button.
- (3) The operation mode is determined by the room temperature at start-up of the operation.

Initial room temperature	mode
25°C or more	COOL mode of "I FEEL CONTROL"
more than 13°C, less than 25°C	DRY mode of "I FEEL CONTROL"

- Once the mode is fixed, the mode will not change by room temperature afterwards.
- Under the ON-TIMER (⊕→|) timer operation, the mode is determined as follows.

When the system is stopped with OPERATE/ STOP (ON/OFF) button on the remote controller, and restarted within 2 hours in "I FEEL CONTROL" (☐) mode, the system operates in previous mode automatically regardless of the room temperature.

INDOOR UNIT DISPLAY SECTION

Operation Indicator lamp

The operation indicator at the right side of the indoor unit indicates the operation state.

- The following indication applies regardless of shape of the indicator.

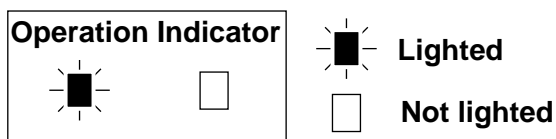

Indication	Operation state	Difference between target temperature and room temperature
	This shows that the air conditioner is operating to reach the target temperature. Please wait until the target temperature is obtained.	Approx. 2 °C or more
	This shows that the room temperature is approaching the target temperature.	Approx. 2 °C or less

Operation timer chart

Example

Previous operation
 COOL mode of "I FEEL CONTROL" or COOL mode

Restart

COOL mode of "I FEEL CONTROL"

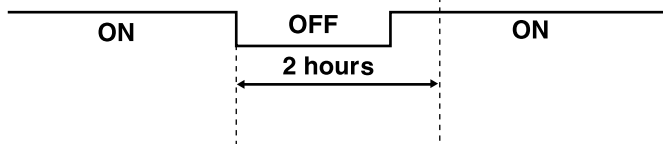

When the system is restarted after 2 hours, the operation mode is determined by the initial room temperature at start-up of the operation.

Operation timer chart

Example

Previous operation
 COOL mode of "I FEEL CONTROL" or COOL mode

Restart

COOL or DRY mode of "I FEEL CONTROL" that is determined by initial room temperature at start-up of the operation.

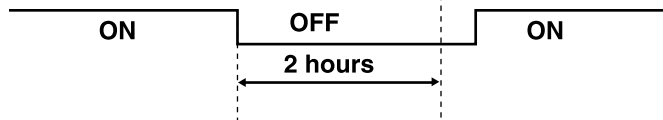

(4) The initial set temperature is decided by the initial room temperature.

Model	Initial room temperature	Initial set temperature
COOL mode of "I FEEL CONTROL"	26°C or more	24°C
	25°C to 26°C	Initial room temperature minus 2°C
DRY mode of "I FEEL CONTROL"	13°C to 25°C	Initial room temperature minus 2°C

※1 When the system is restarted with the remote controller, the system operates with the previous set temperature regardless of the room temperature at restart.
The set temperature is calculated by the previous set temperature.

(5) TEMPERATURE buttons

In "I FEEL CONTROL" mode, set temperature is decided by the microprocessor based on the room temperature. In addition, set temperature is controlled by TOO WARM or TOO COOL buttons when you feel too warm or too cool. Each time TOO WARM or TOO COOL button is pressed, the indoor unit receives the signal and emits a beep tone.

• **Fuzzy control**

When TOO COOL or TOO WARM button is pressed, the microprocessor changes the set temperature, considering the room temperature, the frequency of pressing TOO COOL or TOO WARM button and the user's preference to heat or cold. So this is called "Fuzzy control", and works only in "I FEEL CONTROL" mode.

In DRY mode of "I FEEL CONTROL", the set temperature doesn't change.



...To raise the set temperature 1~2 (°C)



...To lower the set temperature 1~2 (°C)

7-1-1. COOL mode of "I FEEL CONTROL"

1. Thermostat control

Thermostat is ON or OFF by difference between room temperature and set temperature.

Initial temperature difference	Thermostat
Room temperature minus set temperature : 0.3 °C or more.....	ON
Room temperature minus set temperature : less than -0.3 °C	OFF

Difference between room temperature and set temperature during operation

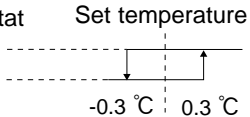

2. Indoor fan speed control

Indoor fan operates continuously at the set speed by FAN SPEED CONTROL button regardless of the thermostat's OFF-ON.

In AUTO the fan speed is as follows.

Initial temperature difference	Fan speed
Room temperature minus set temperature : 1.7 °C or more	High
Room temperature minus set temperature : Between 1 and 1.7 °C	Med.
Room temperature minus set temperature : less than 1 °C	Low

Difference between room temperature and set temperature during operation (Δ T)

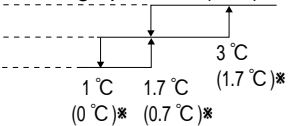

※In case that Δ T has been any following condition for 30 minutes, the value in the parentheses is applied.

- a. Fan speed is Auto Low, and Δ T is 1 °C or more.
- b. Fan speed is Auto Med., and Δ T is 1.7 °C or more.

3. Coil frost prevention

① Temperature control

When the indoor coil thermistor RT12 reads 1°C (MCF-GA35VB)/ -1°C (MCF-GA50/GA60VB) or below, the coil frost prevention mode starts immediately. However the coil frost prevention doesn't work for 5 minutes since the compressor has started.

The indoor fan operates at the set speed the compressor stops for 5 minutes.

After that, if RT12 still reads below 1°C (MCF-GA35VB)/ -1°C (MCF-GA50/GA60VB) this mode is prolonged until RT12 reads over 1°C (MCF-GA35VB)/ -1°C (MCF-GA50/GA60VB).

② Time control

When the three conditions as follows have been satisfied for 1 hour and 45 minutes, compressor stops for 3 minutes. The indoor fan operates at set speed.

- a. Compressor has been continuously operating.
- b. Indoor fan speed is Low or Med.
- c. Room temperature is below 26°C.

When compressor stops, the accumulated time is cancelled and when compressor restarts, time counting starts from the beginning.

Time counting also stops temporarily when the indoor fan speed becomes High or the room temperature exceeds 26°C. However, when two of the above conditions (b. and c.) are satisfied again. Time accumulation is resumed.

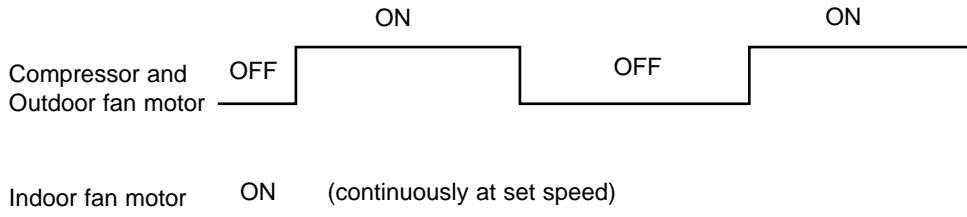

7-1-2. DRY mode of "I FEEL CONTROL"

The system for dry operation uses the same refrigerant circuit as the cooling circuit.

The compressor and the indoor fan are controlled by the temperature.

By such controls, indoor flow amounts will be reduced in order to lower humidity without much room temperature decrease.

1. Thermostat control

Thermostat is ON or OFF by difference between room temperature and set temperature.

Difference between room temperature and set temperature during operation

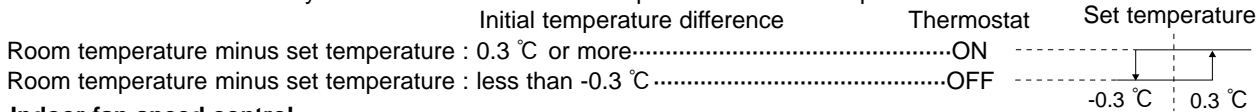

2. Indoor fan speed control

Indoor fan operates at the set speed by FAN SPEED CONTROL button.

However, in AUTO fan operation, fan speed becomes Low.

3. The operation of the compressor and indoor/ outdoor fan

Compressor operates by room temperature control and time control.

Set temperature is controlled to fall 2°C as initial set temperature.

Indoor fan and outdoor fan operate in the same cycle as the compressor.

- When the room temperature is 23°C or over:
 - When the thermostat is ON, the compressor repeats 8 minutes ON and 3 minutes OFF.
 - When the thermostat is OFF, the compressor repeats 4 minutes OFF and 1 minute ON.
- When the room temperature is under 23°C.
 - When the thermostat is ON, the compressor repeats 2 minutes ON and 3 minutes OFF.
 - When the thermostat is OFF, the compressor repeats 4 minutes OFF and 1 minute ON.

Operation time chart

Example

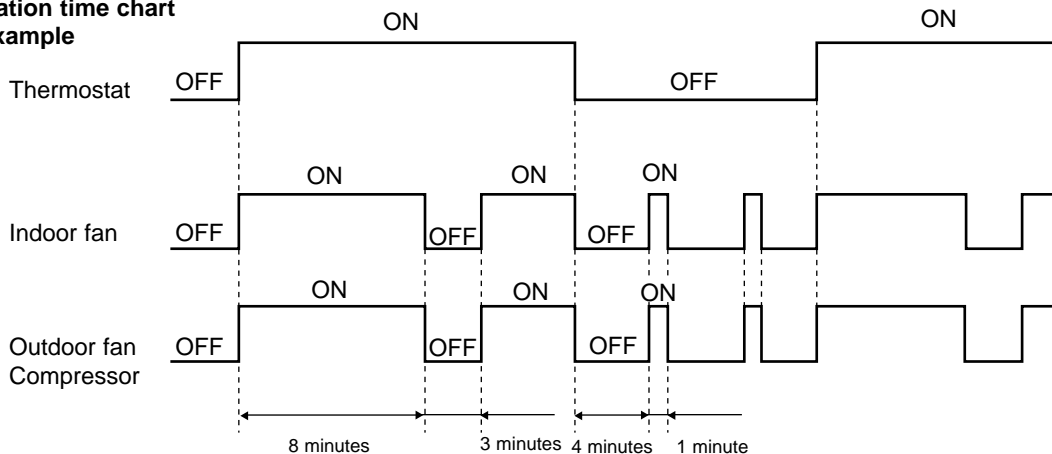

4. Coil frost prevention

- The operation is as same as coil frost prevention during COOL mode of "I FEEL CONTROL".
- Indoor fan operates at the set speed and the compressor stops for 5 minutes, because protection (Coil frost prevention) has the priority. However, when coil frost prevention works while the compressor is not operating, it's speed becomes Low.

7-2. COOL (❄️) OPERATION

- (1) Press OPERATE/STOP (ON/OFF) button.
OPERATION INDICATOR lamp of the indoor unit turns on with a beep tone.
- (2) Select COOL mode with OPERATION SELECT button.
- (3) Press TEMPERATURE buttons.
(TOO WARM or TOO COOL button)
The setting range is 16 ~ 31°C.
* Indoor fan continues to operate regardless of thermostat's OFF-ON.
* Coil frost prevention is as same as COOL mode of "I FEEL CONTROL".

7-3. DRY (☀️) OPERATION

- (1) Press OPERATE/STOP (ON/OFF) button.
OPERATION INDICATOR lamp of the indoor unit turns on with a beep tone.
- (2) Select DRY mode with the OPERATION SELECT button.
- (3) The microprocessor reads the room temperature and determines the set temperature. Set temperature is as shown in the right chart.
Thermostat (SET TEMP.) does not work.
The other operations are same as DRY mode of "I FEEL CONTROL".
- (4) DRY operation will not work when the room temperature is 13°C or below.

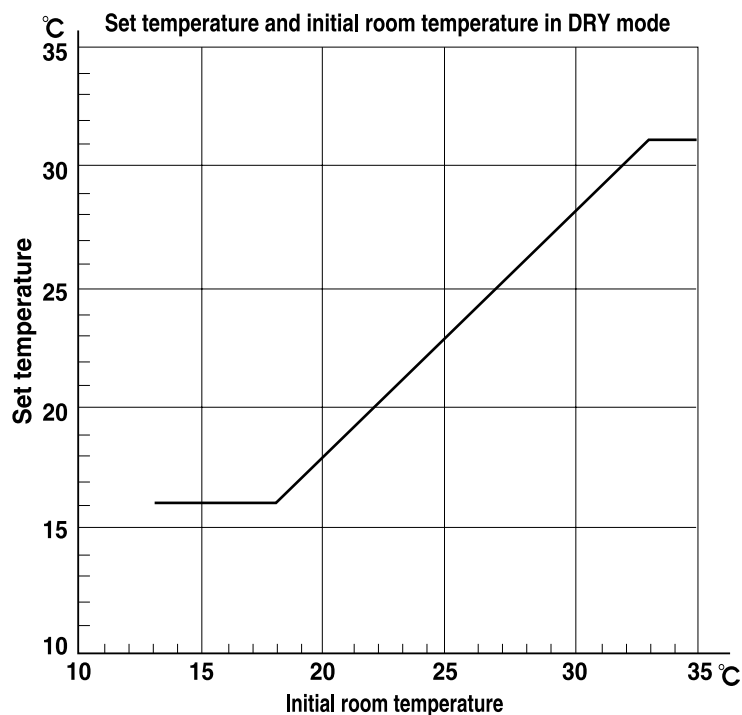

7-4. FAN (🌀) OPERATION

- (1) Press OPERATE/STOP (ON/OFF) button.
- (2) Select FAN mode with OPERATION SELECT button.
- (3) Select the desired fan speed. When AUTO, it becomes Low.
Only indoor fan operates.
Outdoor unit does not operate.

7-5. AUTO VANE OPERATION

- (1) Vane motor drive
This series is equipped with a stepping motor for the vane. The rotating direction, speed, and angle of the motor are controlled by pulse signals (approx. 12V, transmitted from indoor microprocessor.)
- (2) Each time the VANE CONTROL button is pressed, angle of horizontal vane is changed in sequence, from 1, 2, 3, 4, 5, SWING to AUTO.

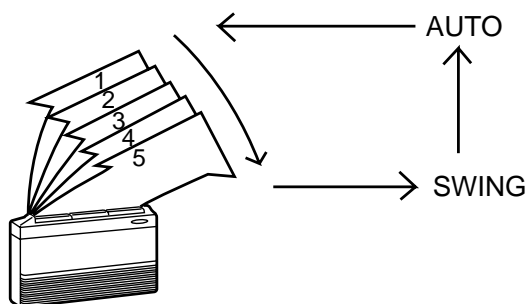

(3) Positioning

The vane presses the vane stopper once to confirm the standard position and then moves to the set angle. Confirming of standard position is performed in case of follows.

- (a) When the power supply turns ON.
- (b) When the operation starts or finishes (including timer operation).
- (c) When the test run starts.
- (d) When the vane control is changed AUTO to MANUAL (except SWING).
- (e) When SWING is finished (including ECONO COOL).

(4) VANE AUTO (⊙) mode

The microprocessor automatically determines the vane angle and operation to make the optimum room temperature distribution.

COOL and DRY operation
Vane angle is fixed to Angle 1.

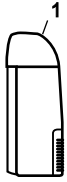

FAN operation
Vane angle is fixed to Angle 4.

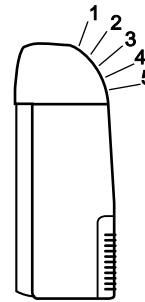
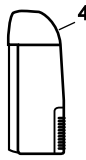

(5) STOP and ON-TIMER standby

When the following cases occur, the vane returns to the closed position.

- (a) When the operation is stopped by the remote controller.
- (b) When the operation is stopped by the emergency operation.
- (c) When ON-timer is on standby.

(6) Dew prevention

During COOL or DRY operation at position 4 or 5 when the compressor cumulative operation time exceeds 1 hour, the angle of horizontal vane automatically changes to position 1 for dew prevention.

(7) SWING MODE (↕)

By selecting SWING mode with VANE CONTROL button, the horizontal vane swings vertically. The remote controller displays "↕". SWING mode is cancelled when VANE CONTROL button is pressed once again.

(8) ECONO COOL (⚙) operation (ECONOMICAL operation)

When ECONO COOL button is pressed in COOL mode, set temperature is automatically set 2°C higher. Also the horizontal vane swings in various cycle according to the temperature of indoor heat exchanger (RT12). SWING operation makes you feel cooler than set temperature. So, even though the set temperature is higher, the air conditioner can keep comfort. As a result, energy can be saved. ECONO COOL operation is cancelled when ECONO COOL button is pressed once again or VANE CONTROL button is pressed or change to other operation mode.

NOTE : ECONO COOL operation does not work in COOL mode of "I FEEL CONTROL".

<SWING operation>

In swing operation of ECONO COOL operation mode, the initial air flow direction is adjusted to "Horizontal". According to the temperature of indoor coil thermistor RT12 at starting of this operation, next downward blow time is decided. Then when the downward blow has been finished, next horizontal blow time is decided. For initial 10 minutes the swing operation is performed in table G~H for quick cooling. Also, after 10 minutes when the difference of set temperature and room temperature is more than 2 °C, the swing operation is performed in table D~H for more cooling. The air conditioner repeats the swing operation in various cycle as follows.

	Temperature of indoor coil thermistor RT12	Downward blow time (second)	Horizontal blow time (second)
A	15°C or less	2	23
B	15°C to 17°C	5	20
C	17°C to 18°C	8	17
D	18°C to 20°C	11	14
E	20°C to 21°C	14	11
F	21°C to 22°C	17	8
G	22°C to 24°C	20	5
H	more than 24°C	23	2

7-6. TIMER OPERATION

1. How to set the timer

- (1) Press OPERATE/STOP(ON/OFF) button to start the air conditioner.
- (2) Check that the current time is set correctly.

NOTE : Timer operation will not work without setting the current time. Initially "AM0:00" blinks at the current time display of TIME MONITOR, so set the current time correctly with CLOCK SET button.

- (3) Press ON/OFF TIMER buttons to select the operation.

"ON-TIMER" button ... AUTO START operation (ON timer)

"OFF-TIMER" button ... AUTO STOP operation (OFF timer)

- (4) Press HR. and MIN. button to set the timer. Time setting is 10-minute units.
HR. and MIN. button will work when "⊕→|" or "⊕→○" mark is flashing.
These marks disappear in 1 minute.

After setting ON timer, check that OPERATION INDICATOR lamp of the indoor unit lights.

NOTE1 : Be sure to place the remote controller at the position where its signal can reach the air conditioner even during TIMER operation, or the set time may deviate within the range of about 10 minutes.

NOTE2 : Reset the timer in the following cases, or the set time may deviate and other malfunctions may occur.

- A power failure occurs.
- The circuit breaker functions.

2. Cancel

TIMER setting can be cancelled with ON/OFF TIMER buttons. ("⊕→|" or "⊕→○")

To cancel ON timer, press "ON-TIMER" button.

To cancel OFF timer, press "OFF-TIMER" button.

TIMER is cancelled and the display of set time disappears.

PROGRAM TIMER

- OFF timer and ON timer can be used in combination.
- "↓" and "↑" display show the order of OFF timer and ON timer operation.

(Example 1) The current timer is 8:00 PM.

The unit turns off at 11:00 PM, and on at 6:00 AM.

(Example 2) The current time is 11:00 AM.

The unit turns on at 5:00 PM, and off at 9:00 PM.

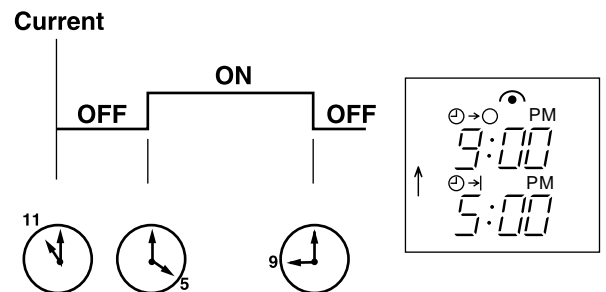
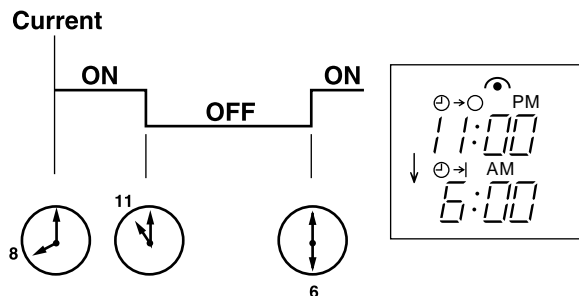

NOTE : TIMER setting will be cancelled by power failure or breaker functioning.

7-7. EMERGENCY / TEST OPERATION

In case of test run operation or emergency operation, use EMERGENCY OPERATION switch on the front of the indoor unit. Emergency operation is available when the remote controller is missing, has failed or the batteries of remote controller run down. The unit will start and OPERATION INDICATOR lamp will light.

The first 30 minutes of operation is the test run operation. This operation is for servicing. The indoor fan speed runs at High speed and the system is in continuous operation. (The thermostat is ON.)

After 30 minutes of test run operation, the system shifts to EMERGENCY COOL MODE with a set temperature of 24°C. The fan speed shifts to Med. speed.

The coil frost prevention works even in emergency operation.

In the test run or emergency operation, the horizontal vane operates in VANE AUTO (@) mode.

Emergency operation continues until EMERGENCY OPERATION switch is pressed again or the unit receives any signal from the remote controller. In case of latter, normal operation will start.

NOTE : Do not press EMERGENCY OPERATION switch during normal operation.

EMERGENCY OPERATION switch

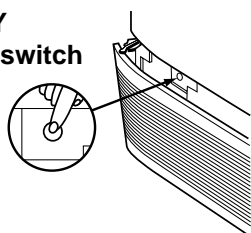

- The following indication applies regardless of shape of the indicator.



OPERATION INDICATOR lamp

Press once <Cool> 

Press again <Stop>

 Lighted

Not lighted

MCFH-GA35VB MUCFH-GA35VB
MCFH-GA50VB MUCFH-GA50VB
MCFH-GA60VB MUCFH-GA60VB

WIRELESS REMOTE CONTROLLER

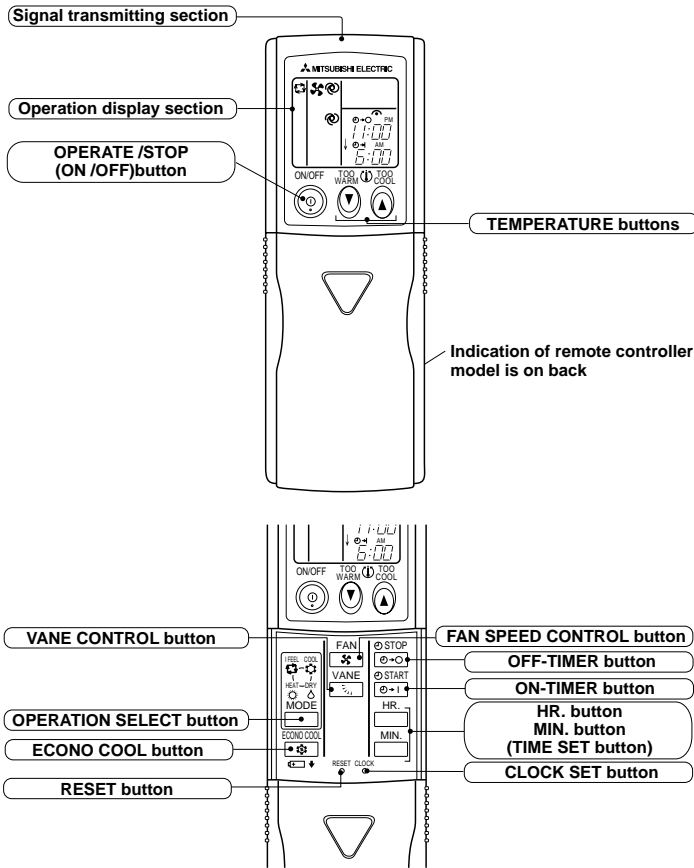

Once the operation mode is set, the same operation mode can be repeated by simply turning OPERATE/STOP (ON/OFF) button ON. Indoor unit receives the signal with a beep tone. When the system turns off, 3-minute time delay will operate to protect system from overload and compressor will not restart for 3 minutes.

8-1. "I FEEL CONTROL" (□) OPERATION

- (1) Press OPERATE/STOP(ON/OFF) button on the remote controller. OPERATION INDICATOR lamp of the indoor unit turns on with a beep tone.
- (2) Select "I FEEL CONTROL" (□) mode with OPERATION SELECT button.
- (3) The operation mode is determined by the room temperature at start-up of the operation.

Initial room temperature	Mode
25°C or more	COOL mode of "I FEEL CONTROL"
23°C to 25°C	DRY mode of "I FEEL CONTROL"
less than 23°C	HEAT mode of "I FEEL CONTROL"

- Once the mode is fixed, the mode does not change by room temperature afterwards.
- Under ON-TIMER (⊕ → |) operation, mode is determined as follows.

When the system is stopped with OPERATE/STOP(ON/OFF) button on the remote controller, and restarted within 2 hours in "I FEEL CONTROL" (□) mode, the system operates in previous mode automatically regardless of the room temperature.

Operation time chart Example

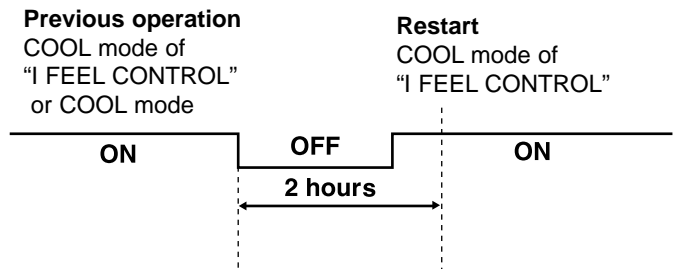

When the system is restarted after 2 hours and more, the operation mode is determined by the room temperature at start-up of the operation.

Operation time chart Example

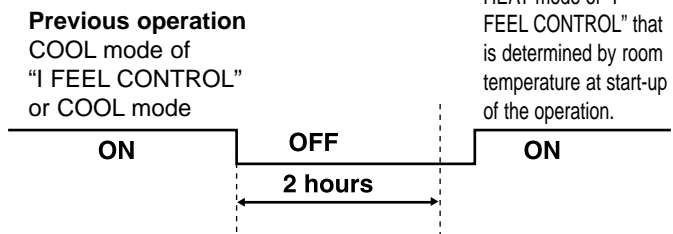

INDOOR UNIT DISPLAY SECTION

Operation Indicator lamp

The operation indicator at the right side of the indoor unit indicates the operation state.

- The following indication applies regardless of shape of the indicator.

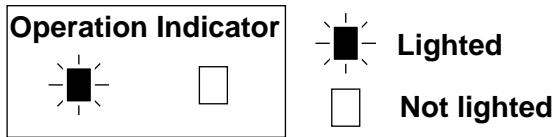

Indication	Operation state	Difference between target temperature and room temperature
Two lighted lamps	This shows that the air conditioner is operating to reach the target temperature. Please wait until the target temperature is obtained.	Approx. 2°C or more
One lighted lamp and one not lighted lamp	This shows that the room temperature is approaching the target temperature.	Approx. 2°C or less

(4) The initial set temperature is decided by the initial room temperature.

Model	Initial room temperature	Initial set temperature
COOL mode of "I FEEL CONTROL"	26°C or more	24°C
	25°C to 26°C	Initial room temperature minus 2°C
DRY mode of "I FEEL CONTROL"	23°C to 25°C	Initial room temperature minus 2°C
HEAT mode of "I FEEL CONTROL"	less than 23°C	26°C

※1 When the system is restarted with the remote controller, the system operates with the previous set temperature regardless of room temperature at restart.
The set temperature is calculated by the previous set temperature.

(5) TEMPERATURE buttons

In "I FEEL CONTROL" mode, set temperature is decided by the microprocessor based on the room temperature. In addition, set temperature can be controlled by TOO WARM or TOO COOL buttons when you feel too warm or too cool. Each time TOO WARM or TOO COOL button is pressed, the indoor unit receives the signal and emits a beep tone.

● Fuzzy control

When TOO COOL or TOO WARM button is pressed, the microprocessor changes the set temperature, considering the room temperature, the frequency of pressing TOO COOL or TOO WARM button, and the user's preference to heat or cool. So this is called "Fuzzy control", and works only in "I FEEL CONTROL" mode. In DRY mode of "I FEEL CONTROL", the set temperature doesn't change.

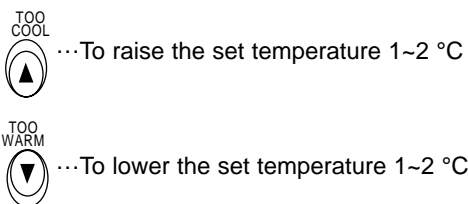

8-1-1. COOL mode of "I FEEL CONTROL"

1. Thermostat control

Thermostat is ON or OFF by difference between room temperature and set temperature.

Initial temperature difference Thermostat
 Room temperature minus set temperature : 0.3 °C or more.....ON
 Room temperature minus set temperature : less than -0.3 °COFF

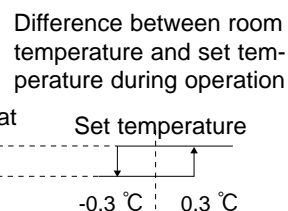

2. Indoor fan speed control

Indoor fan operates continuously at the set speed by FAN SPEED CONTROL button regardless of the thermostat's OFF-ON. In AUTO the fan speed is as follows.

Initial temperature difference Fan speed
 Room temperature minus set temperature : 1.7 °C or moreHigh
 Room temperature minus set temperature : Between 1 and 1.7 °CMed.
 Room temperature minus set temperature : less than 1 °CLow

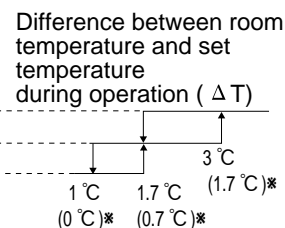

※In case that Δ T has been any following condition for 30 minutes, the value in the parentheses is applied.
 a. Fan speed is Auto Low, and Δ T is 1 °C or more.
 b. Fan speed is Auto Med., and Δ T is 1.7 °C or more.

3. Coil frost prevention

① Temperature control

When the indoor coil thermistor RT12 reads 3°C (MCFH-GA35VB)/ -1°C (MCFH-GA50/GA60VB) or below, the coil frost prevention mode starts immediately. However, the coil frost prevention doesn't work for 5 minutes since the compressor has started. The indoor fan operates at the set speed and the compressor stops for 5 minutes. After that, if RT12 still reads below 3°C (MCFH-GA35VB)/ -1°C (MCFH-GA50/GA60VB), this mode prolonged until RT12 reads over 3°C (MCFH-GA35VB)/ -1°C (MCFH-GA50/GA60VB).

② Time control

When the three conditions as follows have been satisfied for 1 hour and 45 minutes, compressor stops for 3 minutes. The indoor fan operates at set speed.
 a. Compressor has been continuously operating.
 b. Indoor fan speed is Low or Med.
 c. Room temperature is below 26°C.



When compressor stops, the accumulated time is cancelled and when compressor restarts, time counting starts from the beginning.

Time counting also stops temporarily when the indoor fan speed becomes High or the room temperature exceeds 26°C. However, when two of the above conditions (b. and c.) are satisfied again, time accumulation is resumed.

Operation chart

Example

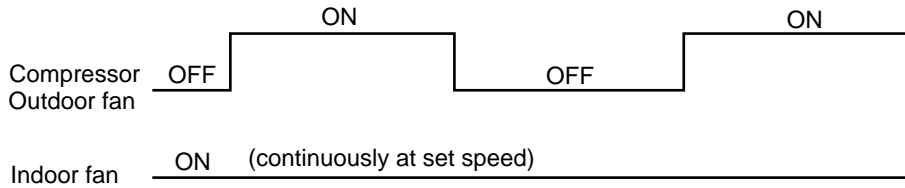

8-1-2. DRY mode of "I FEEL CONTROL"

The system for dry operation uses the same refrigerant circuit as the cooling circuit.

The compressor and the indoor fan are controlled by the room temperature.

By such controls, indoor air flow amounts will be reduced in order to lower humidity without much room temperature decrease.

1. Thermostat control

Thermostat is ON or OFF by difference between room temperature and set temperature.

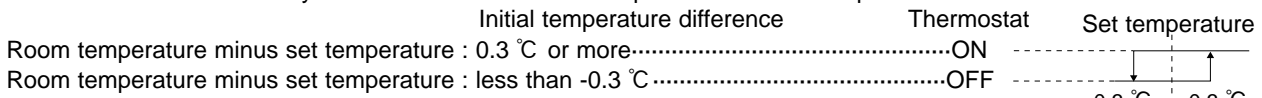

2. Indoor fan speed control

Indoor fan operates at the set speed by FAN SPEED CONTROL button.

However, in AUTO fan operation, fan speed becomes Low.

3. The operation of the compressor and indoor/ outdoor fan

Compressor operates by room temperature control and time control.

Set temperature is controlled to fall 2°C from initial room temperature.

Indoor fan and outdoor fan operate in the same cycle as the compressor.

- When the room temperature is 23°C or over:
 When the thermostat is ON, the compressor repeats 8 minutes ON and 3 minutes OFF.
 When the thermostat is OFF, the compressor repeats 4 minutes OFF and 1 minute ON.
- When the room temperature is under 23°C:
 When the thermostat is ON, the compressor repeats 2 minutes ON and 3 minutes OFF.
 When the thermostat is OFF, the compressor repeats 4 minutes OFF and 1 minute ON.

Operation time chart

Example

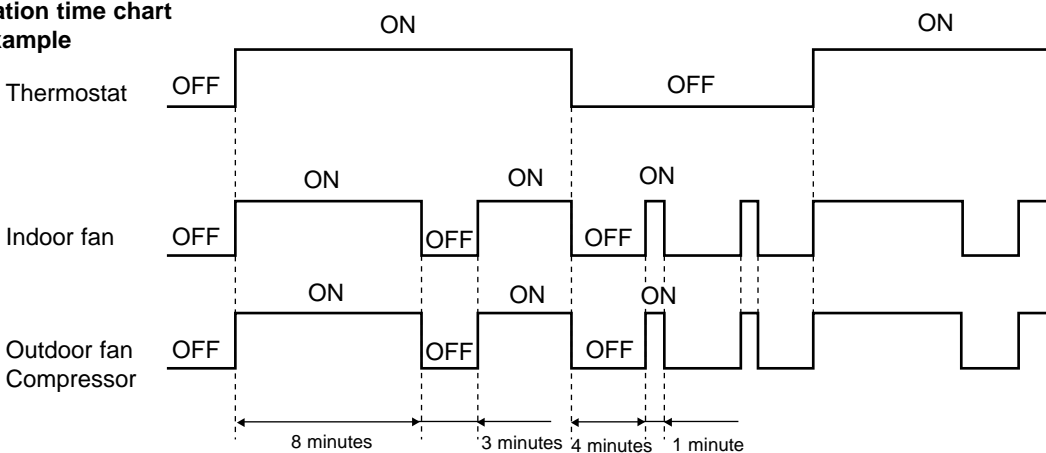

4. Coil frost prevention

- The operation is as same as coil frost prevention during COOL mode of "I FEEL CONTROL".
- Indoor fan operates at the set speed and the compressor stops for 5 minutes, because protection (Coil frost prevention) has the priority.
 However, when coil frost prevention works while the compressor is not operating, its speed becomes Low.

8-1-3. HEAT mode of "I FEEL CONTROL"

1. Thermostat control

Thermostat is ON or OFF by difference between room temperature and set temperature.

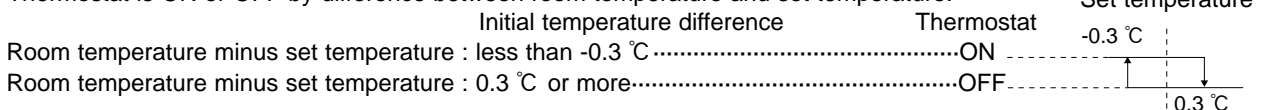

2. Indoor fan speed control

(1) In AUTO the fan speed is as follows.

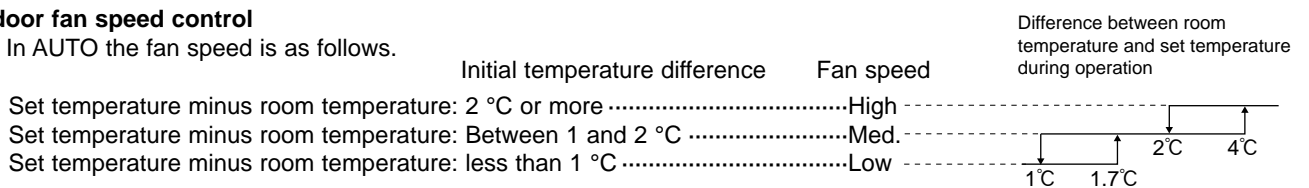

(2) Cold air prevention control

The fan runs at set speed when the indoor coil thermistor RT12 temperature exceeds 22°C. The fan operates at Very Low when the temperature of indoor coil thermistor RT12 is below 18°C. But the fan stops when the indoor fan operates at Very Low and the room temperature is 15°C or less.

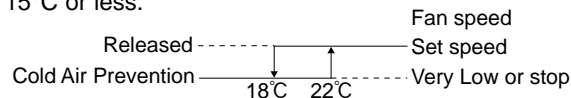

NOTE : If the temperature of RT12 reads from 18°C to 22°C at the air conditioner starting and also after defrosting, this control works.

(3) Warm air control

When compressor starts in heating operation or after defrosting, the fan changes the speed due to the indoor coil thermistor RT12 temperature to blow out warm air.

After releasing of cold air prevention, when the indoor coil temperature is 37°C or above, or when the fan speed is changed by the remote controller, the fan speed shifts to the set speed.

When the indoor coil temperature is less than 37°C, the fan speed is controlled by time as below.

<Time condition>	<Indoor fan speed>
less than 2 minutes	Low
2 minutes to 4 minutes	Med.
4 minutes or more	High

The upper limit of the fan speed is the set speed.

If the thermostat turns off, this operation changes to flow soft control.

(4) Flow soft control

After the thermostat turns off, the indoor fan operates at Very Low.

* When the thermostat turns on, the fan operates at the set speed. Due to the cold air prevention control, the fan does not start at set speed until the indoor coil thermistor RT12 reads 22°C or more.

NOTE : As for high pressure protection, defrosting and R.V. coil control, refer to service manual for outdoor unit.

3. High pressure protection

During heating operation, the outdoor fan motor is controlled by the temperature of indoor coil thermistor RT12 temperature for excess rise protection of compressor discharge pressure.

Outdoor fan OFF : 53°C (MUCFH-GA60VB), 52°C (MUCFH-GA35/GA50VB)

Outdoor fan ON : 50°C (MUCFH-GA60VB), 48°C (MUCFH-GA35/GA50VB)

High pressure protection chart Example

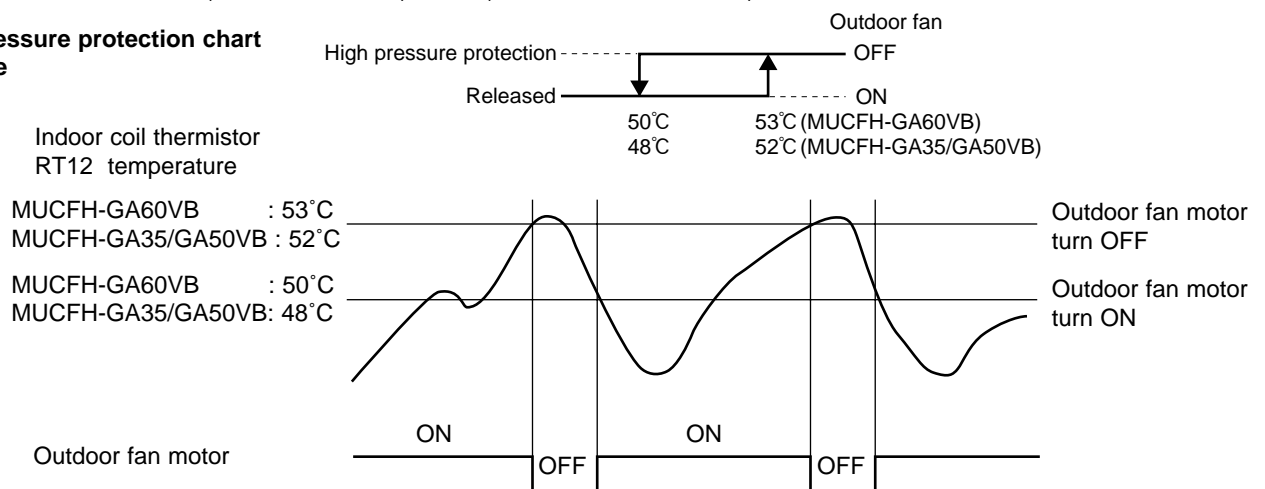

NOTE : When the outdoor fan is OFF in heating, defrosting of outdoor heat exchanger is not detected by the defrost thermistor RT61.

4. Defrosting

Defrosting of outdoor heat exchanger is controlled by DEICER P.C. board, with detection by the defrost thermistor RT61.

(1) Starting conditions of defrost

When all conditions of a) ~ c) are satisfied, the defrosting operation starts.

- The compressor cumulative operation time exceeds 40 minutes without the defrosting operation working.
- The defrost thermistor RT61 reads -3°C or less.
- After releasing the high pressure protection 4 minutes and 15 seconds have elapsed.

(2) Releasing conditions of defrost

When the condition d) or e) is satisfied, the defrosting operation stops.

- The defrost thermistor RT61 reads 3.1°C or more.
- The defrosting time exceeds 10 minutes.

(3) Defrosting time chart

Defrost thermistor RT61

3.1°C or more

-3°C or less

Compressor contactor
(Outdoor 52C)

ON

OFF

X62
(R.V. coil)

ON

OFF

15 seconds

30 seconds

30 seconds

5 seconds

SR61
(Outdoor fan)

ON

OFF

Defrost
counter

ON

OFF

Max. 10 minutes

Indoor fan

NOTE

ON

Very Low

OFF

Indoor vane

Position 1

Set

Position

NOTE : When the indoor coil thermistor reads above 18°C , indoor fan operates at Very Low for 30 seconds.
When the indoor coil thermistor reads 18°C or less, the indoor fan stops.

8-2. COOL (❄) OPERATION

(1) Press OPERATE/STOP(ON/OFF) button.

OPERATION INDICATOR lamp of the indoor unit turns on with a beep tone.

(2) Select COOL mode with OPERATION SELECT button.

(3) Press TEMPERATURE buttons

(TOO WARM or TOO COOL button)
to select the desired temperature.

The setting range is $16 \sim 31^{\circ}\text{C}$.

* Indoor fan continues to operate regardless of thermostat's OFF-ON at set speed.

* Coil frost prevention is same as COOL mode of "I FEEL CONTROL".

8-3. DRY (\triangle) OPERATION

- (1) Press OPERATE/STOP(ON/OFF) button.
OPERATION INDICATOR lamp of the indoor unit turns on with a beep tone.
- (2) Select DRY mode with OPERATION SELECT button.
- (3) The microprocessor reads the room temperature and determines the set temperature. Set temperature is as shown on the right chart.
Thermostat (SET TEMP.) does not work.
The other operations are same as DRY mode of "I FEEL CONTROL".
- (4) DRY operation will not function when the room temperature is 13°C or below.

8-4. HEAT (\odot) OPERATION

- (1) Press OPERATE/STOP(ON/OFF) button.
OPERATION INDICATOR lamp of the indoor unit turns on with a beep tone.
- (2) Select HEAT mode with OPERATION SELECT button.
- (3) Press TEMPERATURE buttons (TOO WARM or TOO COOL button) to select the desired temperature.
The setting range is 16 ~ 31°C.
- (4) Indoor fan speed control is as same as HEAT mode of "I FEEL CONTROL".

8-5. AUTO VANE OPERATION

- (1) Vane motor drive

This series is equipped with a stepping motor for the vane. The rotating direction, speed, and angle of the motor are controlled by pulse signals (approx. 12V) transmitted from indoor microprocessor.

- (2) Each time the VANE CONTROL button is pressed, angle of horizontal vane is changed in sequence, from 1, 2, 3, 4, 5 SWING to AUTO.

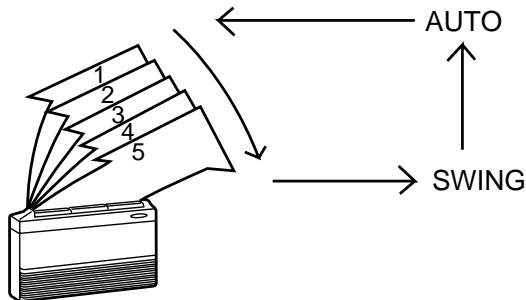

- (3) Positioning

The vane presses the vane stopper once to confirm the standard position and then moves to the set angle. Confirming of standard position is performed in case of follows.

- (a) When the power supply turns ON.
- (b) When the operation starts or finishes (including timer operation).
- (c) When the test run starts.
- (d) When the vane control is changed AUTO to MANUAL (except SWING).
- (e) When SWING is finished (including ECONO COOL).
- (f) When multi-standby starts or finishes.

- (4) VANE AUTO (\odot) mode

The microprocessor automatically determines the vane angle and operation to make the optimum room temperature dis-

COOL and DRY operation

Vane angle is fixed to Angle 1.

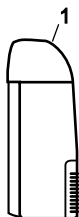

HEAT operation

Vane angle is fixed to Angle 4.

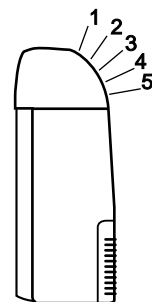
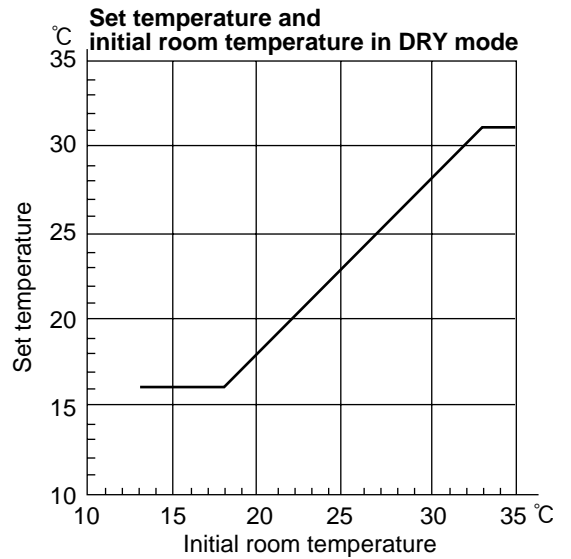
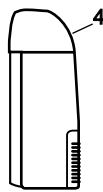

(5) STOP (operation OFF) and ON-TIMER standby

When the following cases occur, the vane returns to the closed position.

- (a) When OPERATE/STOP (ON/OFF) button is pressed (POWER OFF).
- (b) When the operation is stopped by the emergency operation.
- (c) When ON-TIMER is on standby.

(6) Dew prevention

During COOL or DRY operation at Angle 4 or 5 when the compressor cumulative operation time exceeds 1 hour, the angle of horizontal vane automatically changes to Angle 1 for dew prevention.

(7) SWING MODE ()

By selecting SWING mode with VANE CONTROL button, the horizontal vane swings vertically.

The remote controller displays “  ”. SWING mode is cancelled when VANE CONTROL button is pressed once again.

(8) Cold air prevention in HEAT operation.

When any of the following conditions occurs in HEAT operation, the angle of horizontal vane automatically changes to Position 1 to prevent cold air blowing on users.

- ① Compressor is not operating.
- ② Defrosting is performed.
- ③ Indoor coil thermistor RT12 reads 24°C or below.
- ④ Indoor coil thermistor RT12 temperature is raising from 24°C or below, but it does not exceed 28°C.

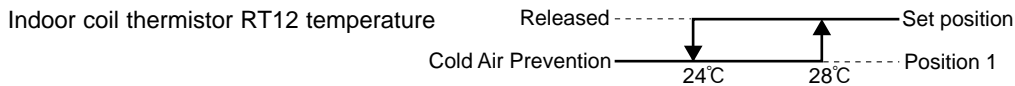

NOTE1: If the temperature of RT12 reads from 24°C to 28°C at the air conditioner starting, this control works.

NOTE2: When 2 or more indoor units are operated with multi outdoor unit, even if any indoor unit turns thermostat off, this control doesn't work in the indoor unit.

(9) ECONO COOL () operation (ECONOMical operation)

When ECONO COOL button is pressed in COOL mode, set temperature is automatically set 2°C higher.

Also the horizontal vane swings in various cycle according to the temperature of indoor heat exchanger(RT12).

SWING operation makes you feel cooler than set temperature. So, even though the set temperature is higher, the air conditioner can keep comfort. As a result, energy can be saved.

ECONO COOL operation is cancelled when ECONO COOL button is pressed once again or VANE CONTROL button is pressed or change to other operation mode.

NOTE : ECONO COOL operation does not work in COOL mode of “I FEEL CONTROL”.

SWING operation

In swing operation of ECONO COOL operation mode, the initial air flow direction is adjusted to “Horizontal”.

According to the temperature of indoor coil thermistor RT12 at starting of this operation, next downward blow time is decided. Then when the downward blow has been finished, next horizontal blow time is decided.

For initial 10 minutes the swing operation is performed in table G~H for quick cooling.

Also, after 10 minutes when the difference of set temperature and room temperature is more than 2 °C, the swing operation is performed in table D~H for more cooling.

The air conditioner repeats the swing operation in various cycle as follows.

	Temperature of indoor coil thermistor RT12	Downward blow time (second)	Horizontal blow time (second)
A	15°C or less	2	23
B	15°C to 17°C	5	20
C	17°C to 18°C	8	17
D	18°C to 20°C	11	14
E	20°C to 21°C	14	11
F	21°C to 22°C	17	8
G	22°C to 24°C	20	5
H	more than 24°C	23	2

8-6. TIMER OPERATION

1. How to set the timer

- (1) Press OPERATE/STOP(ON/OFF) button to start the air conditioner.
- (2) Check that the current time is set correctly.

NOTE : Timer operation will not work without setting the current time. Initially "AM0:00" blinks at the current time display of TIME MONITOR, so set the current time correctly with CLOCK SET button.

- (3) Press ON/OFF TIMER buttons to select the operation.

"ON-TIMER" button ... AUTO START operation (ON timer)

"OFF-TIMER" button ... AUTO STOP operation (OFF timer)

- (4) Press HR. and MIN. button to set the timer. Time setting is 10-minute units.

HR. and MIN. button will work when "⊖→| " or "⊖→○ " mark is flashing.

These marks disappear in 1 minute.

After setting the ON timer, check that OPERATION INDICATOR lamp of the indoor unit lights.

NOTE1 : Be sure to place the remote controller at the position where its signal can reach the air conditioner even during TIMER operation, or the set time may deviate within the range of about 10 minutes.

NOTE2 : Reset the timer in the following cases, or the set time may deviate and other malfunctions may occur.

- A power failure occurs.
- The circuit breaker functions.

2. Cancel

TIMER setting can be cancelled with ON/OFF TIMER buttons. ("⊖→| " or "⊖→○ ")

To cancel ON timer, press "ON-TIMER" button.

To cancel OFF timer, press "OFF-TIMER" button.

TIMER is cancelled and the display of set time disappears.

PROGRAM TIMER

- OFF timer and ON timer can be used in combination.
- "↓" and "↑" display show the order of OFF timer and ON timer operation.

(Example 1) The current timer is 8:00 PM.

The unit turns off at 11:00 PM, and on at 6:00 AM.

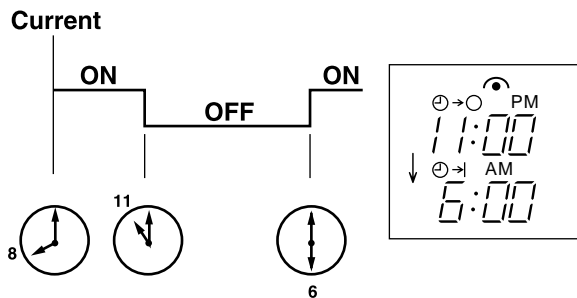

(Example 2) The current time is 11:00 AM.

The unit turns on at 5:00 PM, and off at 9:00 PM.

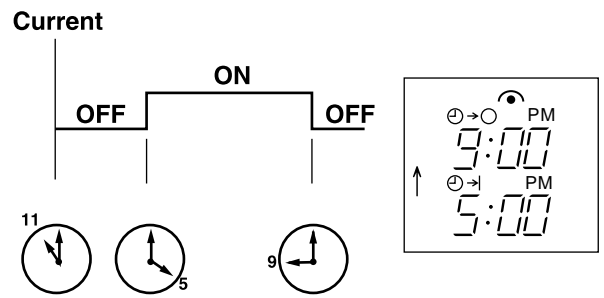

NOTE : TIMER setting will be cancelled by power failure or breaker functioning.

8-7. EMERGENCY / TEST OPERATION

In case of test run operation or emergency operation, use EMERGENCY OPERATION switch on the front of the indoor unit. Emergency operation is available when the remote controller is missing, has failed or the batteries of remote controller run down. The unit will start and OPERATION INDICATOR lamp will light.

The first 30 minutes of operation is the test run operation. This operation is for servicing. The indoor fan speed runs at High speed and the system is in continuous operation. (The thermostat is ON.)

After 30 minutes of test run operation, the system shifts to EMERGENCY COOL / HEAT MODE with a set temperature of 24°C.

The fan speed shifts to Med. speed.

The coil frost prevention works even in emergency operation, and defrosting too.

In the test run or emergency operation, the horizontal vane operates in VANE AUTO (@) mode.

Emergency operation continues until EMERGENCY OPERATION switch is pressed once or twice or the unit receives any signal from the remote controller. In case of latter, normal operation will start.

NOTE : Do not press EMERGENCY OPERATION switch during normal operation.

EMERGENCY OPERATION switch

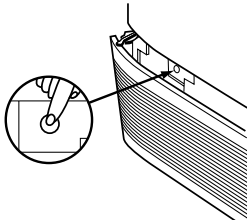

- The following indication applies regardless of shape of the indicator.

OPERATION INDICATOR lamp		
Press once	<Cool>	<input checked="" type="checkbox"/> <input type="checkbox"/>
Press again	<Heat>	<input type="checkbox"/> <input checked="" type="checkbox"/>
Press once again	<Stop>	<input type="checkbox"/> <input type="checkbox"/>

Lighted
 Not lighted

**MFZ-KA25VA
MFZ-KA35VA
MFZ-KA50VA**

WIRELESS REMOTE CONTROLLER

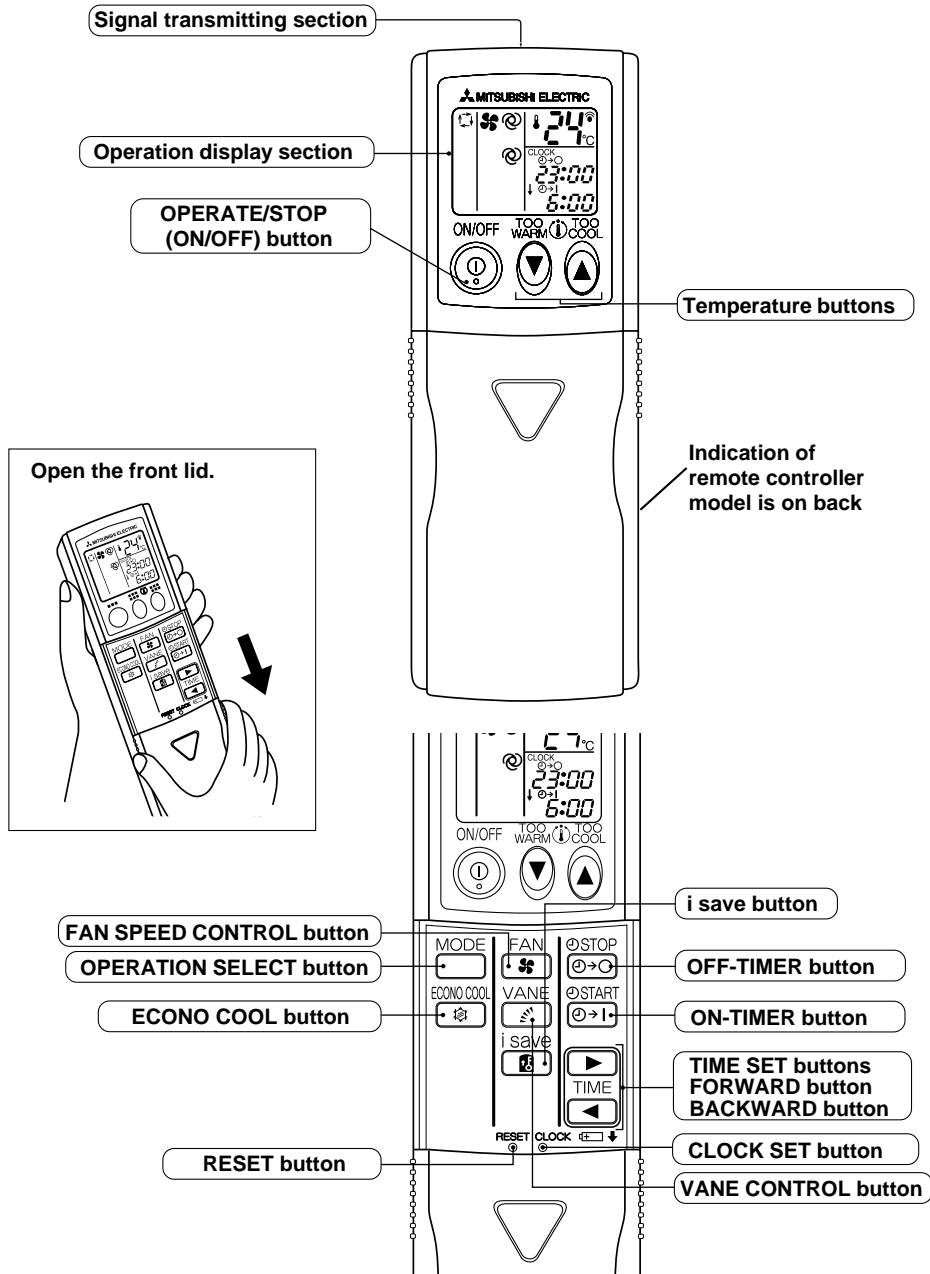

Once the operation mode is set, the same operation mode can be repeated by simply turning OPERATE/STOP (ON/OFF) button ON.

Indoor unit receives the signal with a beep tone.

When the system turns off, 3-minute time delay will operate to protect system from overload and compressor will not restart for 3 minutes.

9-1. COOL (❄) OPERATION

- (1) Press OPERATE/STOP(ON/OFF) button.
POWER lamp of the indoor unit turns on with a beep tone.
- (2) Select COOL mode with OPERATION SELECT button.
- (3) Press TEMPERATURE buttons (TOO WARM or TOO COOL button) to select the desired temperature.
The setting range is 16 ~ 31°C

1. Thermostat control

Thermostat is ON or OFF by difference between room temperature and set temperature

Initial temperature difference	Thermostat	Set temperature
Room temperature minus set temperature : -1.0 °C or more	ON	
Room temperature minus set temperature : less than -1.0 °C	OFF	

2. Indoor fan speed control

Indoor fan operates continuously at the set speed by FAN SPEED CONTROL button regardless of the thermostat's OFF-ON.
In AUTO the fan speed is as follows.

Initial temperature difference	Fan speed	Difference between room temperature and set temperature during operation
Room temperature minus set temperature : 1.7 °C or more	High	
Room temperature minus set temperature : Between 1 and 1.7 °C	Med.	
Room temperature minus set temperature : less than 1 °C	Low	

3. Coil frost prevention

Temperature control

When indoor coil thermistor detects following temperature for 90 seconds, operational frequency of compressor is controlled according to the following table.

Temperature of indoor coil thermistor	Operation frequency
10°C or more	Normal (variable)
8°C to 10°C	Raise 6 Hz
6°C to 8°C	Fixed
3°C to 6°C	Lower 3Hz
3°C or less	Lower 6Hz Compressor is turned OFF for 5 minutes when temperature of indoor coil thermistor continues 3°C or less for 5 minutes or more.

The indoor fan maintains the actual speed of the moment.

4. Low outside temperature operation

If the outside temperature falls to 18°C or less during operation in COOL mode, the unit enters the low outside temperature operation mode.

<Operation>

- (1) If the unit enters the low outside temperature operation mode, the outside fan rotation speed gets slow down.
- (2) Even when the unit is in the "thermostat-off" status under the low outside temperature operation mode, the outside fan rotation does not stop.
- (3) In this mode to detect the exact outside temperature the compressor turns OFF with the outdoor fan ON for 3 minutes once 1 hour; if the outside temperature rises over 18°C, the unit goes back to the normal COOL mode, and if the outside temperature is still 18°C or less, the unit stays in the low outside temperature operation mode.
- (4) Dew drop prevention

When the ambient temperature thermistor RT65 reads -12°C or less, as coil frost or dew drop from indoor unit may occur, the compressor turns OFF with the outdoor fan ON for prevention of them.

NOTE: This control can be released by cut of the jumper line JG on the outdoor inverter P.C. board.

Be sure to cut it since user accepts that maker can't be responsible for coil frost or dew drop from indoor unit.

※Other protections work as well as in the normal COOL mode.

NOTE : Even when the damper is closed while cooling or drying operation is performed, the lower fan may rotate intermittently.

9-2. DRY (\triangle) OPERATION

- (1) Press OPERATE/STOP(ON/OFF) button.
POWER lamp of the indoor unit turns on with a beep tone.
- (2) Select DRY mode with OPERATION SELECT button.
- (3) The microprocessor reads the room temperature and determines the set temperature. Set temperature is as shown on the right chart.

The system for dry operation uses the same refrigerant circuit as the cooling circuit.
The compressor and the indoor fan are controlled by the room temperature.
By such controls, indoor flow amounts will be reduced in order to lower humidity without much room temperature decrease.

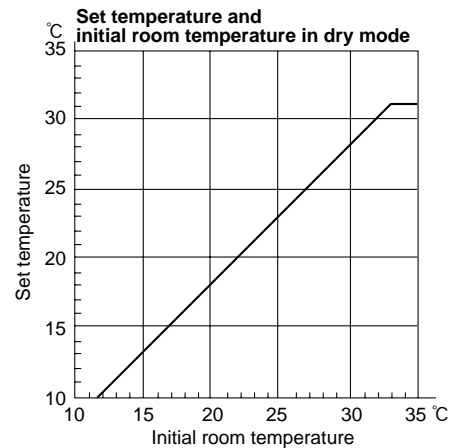

1. Thermostat control

Thermostat is ON or OFF by difference between room temperature and set temperature.

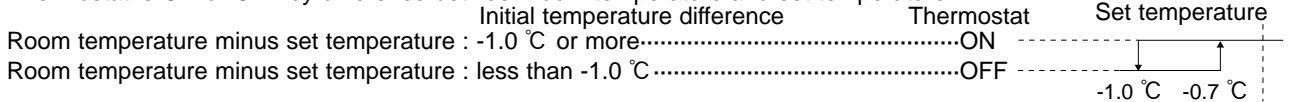

2. Indoor fan speed control

Indoor fan operates at the set speed by FAN SPEED CONTROL button.
When thermostat OFF (compressor OFF) fan speed becomes Very Low.

In AUTO the fan speed is as follows.

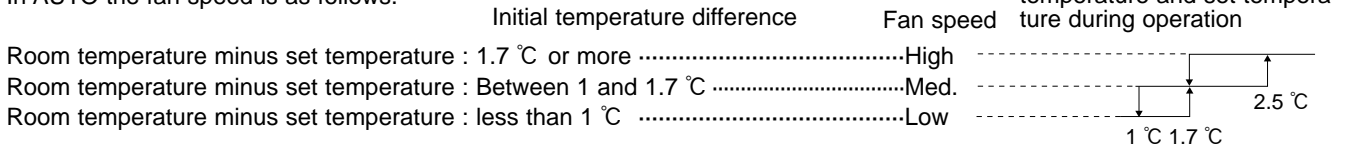

3. Coil frost prevention

Coil frost prevention is as same as COOL mode. (9-1.3.)
The indoor fan maintains the actual speed of the moment.

4. Low outside temperature operation

Low outside temperature operation is as same as COOL mode. (9-1.4.)

NOTE : Even when the damper is closed while cooling or drying operation is performed, the lower fan may rotate intermittently.

9-3. HEAT (\odot) OPERATION

- (1) Press OPERATE/STOP(ON/OFF) button.
POWER lamp of the indoor unit turns on with a beep tone.
- (2) Select HEAT mode with OPERATION SELECT button.
- (3) Press TEMPERATURE buttons (TOO WARM or TOO COOL button) to select the desired temperature.
The setting range is $16 \sim 31^{\circ}\text{C}$.

1. Thermostat control

Thermostat is ON or OFF by difference between room temperature and set temperature.

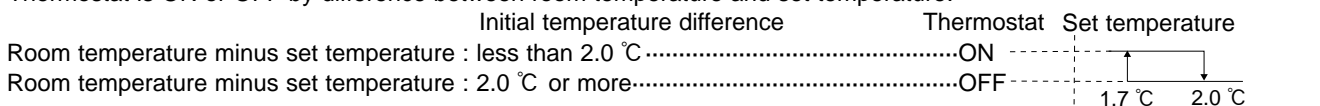

2. Indoor fan speed control

- (1) Indoor fan operates at the set speed by FAN SPEED CONTROL button.
In Auto the fan speed is as follows.

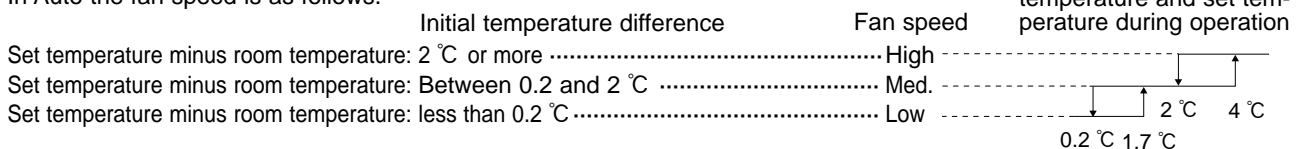

(2) Cold air prevention control

- ① When the compressor is not operating,
 - (I) if the temperature of room temperature thermistor RT11 is less than 19°C, the fan stops.
 - (II) if the temperature of room temperature thermistor RT11 is 19°C or more and
 - (i) if the temperature of indoor coil thermistor is less than 0°C, the fan stops.
 - (ii) if the temperature of indoor coil thermistor is 0°C or more, the fan operates at Very Low.
- ② When the compressor is operating,
 - (I) if the temperature of indoor coil thermistor is 40°C or more, the fan operates at set speed.
 - (II) if the temperature of indoor coil thermistor is less than 40°C and
 - (i) if heating operation starts after defrosting, the fan stops.
 - (ii) if the temperature of room temperature thermistor RT11 is 19°C or less, the fan stops.
 - (iii) if the temperature of room temperature thermistor RT11 is more than 19°C, the fan operates at Very Low.

NOTE : When 3 minutes have passed since the compressor started operation, this control is released regardless of the temperature of RT11 and indoor coil thermistor.

3. High pressure protection

In HEAT operation the indoor coil thermistor detects the temperature of the indoor heat exchanger. The compressor operational frequency is controlled to prevent the condensing pressure from increasing excessively.

4. Overload starting

When the room temperature thermistor RT11 reads 18°C or more (SUZ-KA25/35) / 25°C or more (SUZ-KA50), the compressor runs with its maximum frequency regulated for 10 minutes after the start-up.

5. Defrosting

(1) Starting conditions of defrosting

When the following conditions a) ~ c) are satisfied, the defrosting starts.

- a) The defrost thermistor reads -3°C or less.
- b) The cumulative operation time of the compressor has reached any of the set values* [30, 35, 40, 45, 55, 65, 75, 85, 95, 105, 115, 125, 150 minutes (SUZ-KA25/35) / 31, 35, 45, 55, 65, 75, 85, 95, 105, 115, 150 minutes (SUZ-KA50)].
- c) More than 5 minutes have passed since the start-up of the compressor.

* Set value of compressor operation time(hereinafter referred to as defrost interval)

This is decided by the temperature of defrost thermistor and ambient temperature thermistor, the previous defrosting time. For example, the first defrost interval is 40 minutes long, and the second is 45 minutes long. The third and subsequent intervals are set to be longer, and less frequent, depending on defrosting time.

The third and subsequent defrost intervals follow any of the three patterns ...5 or 10 to 20 minutes longer, the same, or 5 or 10 to 20 minutes shorter compared with the previous defrost interval ... with the longest 150 minutes and the shortest 30 minutes.

(2) Releasing conditions of defrosting

Defrosting is released when any of the following conditions is satisfied:

- a) The defrost thermistor continues to read 5°C or more (SUZ-KA25VA) / 8°C or more (SUZ-KA25VAH) / 10°C or more (SUZ-KA35VA) / 13°C or more (SUZ-KA35VAH) / 15°C or more (SUZ-KA50VA) for 30 seconds.
- b) Defrosting time has exceeded 10 minutes.
- c) Any other mode than HEAT mode is set during defrosting.

6. Defrost heater (SUZ-KA25/ KA35VAH)

(1) Starting conditions

When all of the following conditions a) ~ d) are satisfied, defrost heater turns ON to prevent ice from foaming on the base of outdoor unit.

- a) HEAT mode is selected.
- b) The ambient temperature thermistor RT65 reads 5°C or less for 5 minutes continuously. (NOTE 1).
- c) The defrost thermistor RT61 reads -1°C or less for 5 minutes continuously.
- d) Outdoor fan motor is turned ON.

(2) Releasing conditions

When any of the following conditions is satisfied, defrost heater turns OFF.

- a) Any other mode than HEAT mode is selected. (NOTE 2).
- b) The ambient temperature thermistor RT65 reads 8°C or more for 5 minutes continuously. (NOTE 1).
- c) The defrost thermistor RT61 reads more than 15°C for 5 minutes continuously.
- d) Outdoor fan motor is turned OFF.

NOTE1 : Ambient temperature thermistor RT65.

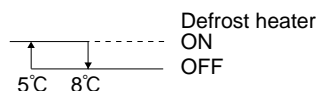

NOTE2 : During defrosting operation defrost heater continues to be ON.

Time chart of defrosting in HEAT mode (reverse type)

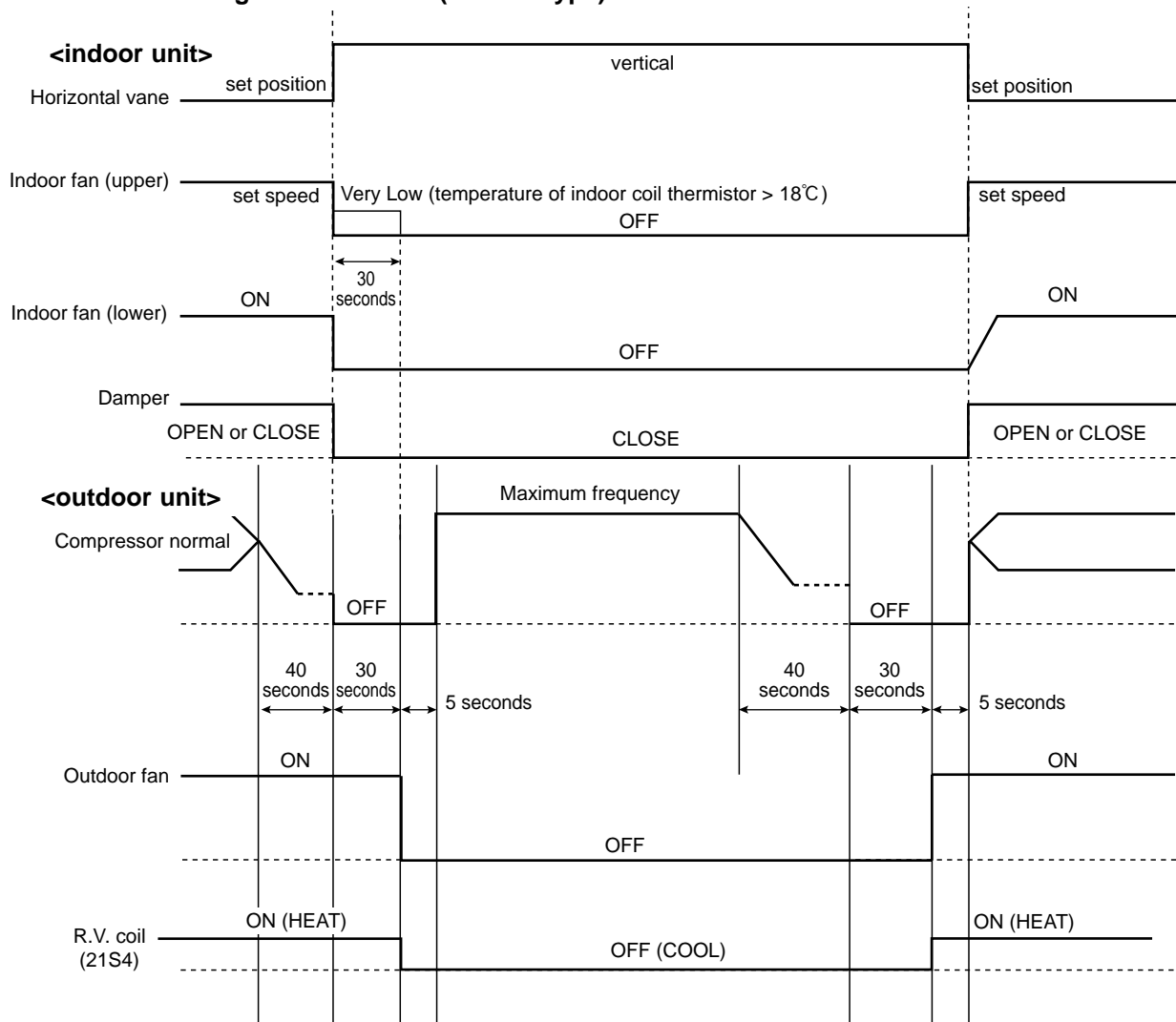

NOTE : When the air outlet selection switch is set to blow out air from the upper air outlet only, the damper is closed and the lower fan motor is OFF at all times.

9-4. AUTO CHANGE OVER ... AUTO MODE OPERATION

Once desired temperature is set, unit operation is switched automatically between COOL and HEAT operation.

1. Mode selection

(1) Initial mode

At first indoor unit operates only indoor fan with outdoor unit OFF for 3 minutes to detect present room temperature. Following the conditions below, operation mode is selected.

- ① If the room temperature thermistor RT11 reads more than set temperature, COOL mode is selected.
- ② If the room temperature thermistor RT11 reads set temperature or less, HEAT mode is selected.

(2) Mode change

In case of the following conditions the operation mode is changed.

- ① COOL mode changes to HEAT mode when 15 minutes have passed with the room temperature 2 degrees below the set temperature.
- ② HEAT mode changes to COOL mode when 15 minutes have passed with the room temperature 2 degrees above the set temperature.

In the other cases than the above conditions, the present operation mode is continued.

NOTE1: Mode selection is performed when multi standby (refer to NOTE2) is released and the unit starts operation with ON-timer.

NOTE2: If two or more indoor units are operating in multi system, there might be a case that the indoor unit, which is operating in AUTO (□), cannot change over the other operating mode (COOL ↔ HEAT) and becomes a state of standby.

(3) Indoor fan control/ Vane control

As the indoor fan speed and the horizontal vane position depend on the selected operation mode, when the operation mode changes over, they change to the exclusive ones.

9-5. INDOOR FAN MOTOR CONTROL

(1) Rotational frequency feedback control

The indoor fan motor is equipped with a rotational frequency sensor, and outputs signal to the microprocessor to feedback the rotational frequency. Comparing the current rotational frequency with the target rotational frequency (Super High, High, Med., Low), the microprocessor adjusts fan motor electric current to make the current rotational frequency close to the target rotational frequency. With this control, when the fan speed is switched, the rotational frequency changes smoothly.

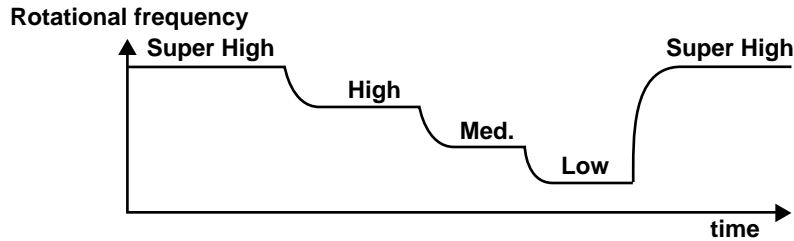

(2) Fan motor lock-up protection

When the rotational frequency feedback signal has not output for 12 seconds, (or when the microprocessor cannot detect the signal for 12 seconds) energizing to the fan motor is stopped. Then the microprocessor retries detection 3 times every 30 seconds. If the microprocessor still cannot detect the signal, the fan motor is regarded locked-up. When the fan motor lock-up, POWER lamp flashes on and off to show the fan motor abnormality.

9-6. OUTDOOR FAN MOTOR CONTROL

Fan speed is switched according to the compressor frequency.

Fan speed

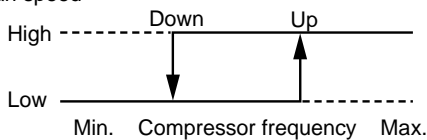

<Relation between compressor frequency and fan speed>

Mode	Fan speed	Compressor frequency		
		SUZ-KA25	SUZ-KA35	SUZ-KA50
COOL	Up	54Hz	43Hz	44Hz
	Down	41Hz	33Hz	33Hz
HEAT	Up	54Hz	43Hz	52Hz
	Down	41Hz	33Hz	42Hz

9-7. AUTO VANE OPERATION

Horizontal vane

(1) Vane motor drive

These models are equipped with a stepping motor for the horizontal vane. The rotating direction, speed, and angle of the motor are controlled by pulse signals (approx. 12V) transmitted from indoor microprocessor.

(2) The horizontal vane angle and mode change as follows by pressing VANE CONTROL button.

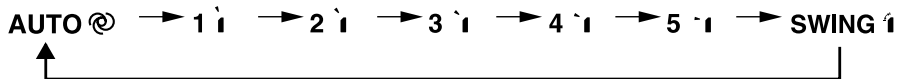

(3) Positioning

The vane presses the vane stopper once to confirm the standard position and then moves to the set angle. Confirming of standard position is performed in case of follows.

- When the power supply turns on.
- When the operation starts or finishes (including timer operation).
- When the test run starts.
- When multi-standby starts or finishes.
- When the swing operation finishes.

(4) VANE AUTO (Ⓢ) mode

The microprocessor automatically determines the vane angle and operation to make the optimum room temperature distribution.

COOL and DRY operation

Vane angle is fixed to Angle 1.



HEAT operation

When air comes out from upper air outlet, vane angle is fixed to Angle 5.



When air comes out from upper and lower air outlets, vane angle is fixed to Angle 3.

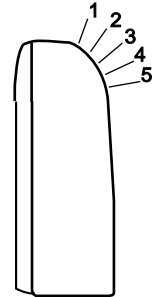

(5) STOP (operation OFF) and ON-TIMER standby

When the following cases occur, the horizontal vane returns to the closed position.

- (a) When OPERATE/STOP (ON/OFF) button is pressed (POWER OFF).
- (b) When the operation is stopped by the emergency operation.
- (c) When ON-TIMER is ON standby.

(6) Dew prevention

During COOL or DRY operation with the vane angle at Angle 3 ~ 5 when the compressor cumulative operation time exceeds 30 minutes to 1 hour, the vane angle automatically changes to Angle 1 for dew prevention.

(7) SWING MODE (↕)

By selecting SWING mode with VANE CONTROL button, the horizontal vane swings vertically. The remote controller displays "↕". SWING mode is cancelled when VANE CONTROL button is pressed once again.

(8) Cold air prevention in HEAT operation

When any of the following conditions occurs in HEAT operation, the vane angle changes to Horizontal position automatically to prevent cold air blowing on users.

- ① Compressor is not operating.
- ② Defrosting is performed.
- ③ Indoor coil thermistor RT12 reads 24°C or below.
- ④ Indoor coil thermistor RT12 temperature is raising from 24°C or below, but it does not exceed 39°C.

Indoor coil thermistor RT12 temperature

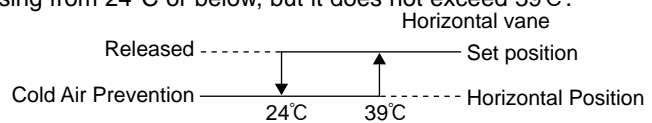

NOTE : The horizontal vane automatically moves in certain intervals to determine its position, and then it returns to the set position.

(9) Damper operation

NOTE 1 : Be sure to turn off the air conditioner before changing the switch setting.

With this function, air comes out simultaneously from the upper and lower air outlets so that the room can be cooled or heated effectively. This function is set using the switch behind the front grille of the indoor unit. (This function is available in cooling and heating operation.)

1.How to set to blow out air from the upper and lower air outlets:

Set the air outlet selection switch to .

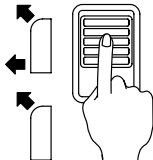

2.How to set to blow out air from the upper air outlet only:

Set the air outlet selection switch to .

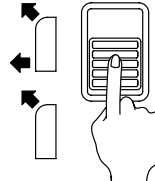

Air blows out automatically from the upper and lower air outlets as shown in the table below.

NOTE 2 : Set the air outlet selection switch to the end correctly. Otherwise, air outlet cannot be selected as intended.

Description of operation

The direction (opening and closing of the damper) and the volume of the airflow from the lower air outlet are controlled automatically.

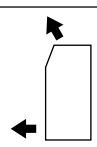
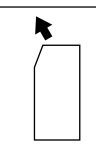
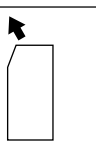
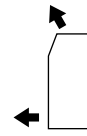
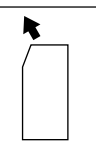
Operation	COOL		DRY	HEAT	
Air flow	 Upper and lower air flow	 Upper air flow	 Upper air flow only	 Upper and lower air flow	 Upper air flow
Conditions	Room temperature and set temperature are different.	Room temperature is close to set temperature, or the air conditioner has operated for 1 hour.	—	Air flow temperature is high.	Air flow temperature is low. (During defrosting operation, start of operation, etc.)

- Be sure to keep the area around the damper of the lower air outlet free of any objects. If any objects block the normal operation of the damper, the left operation indicator lamp may blink.

Indoor fan motor (Lower) in COOL OPERATION

Difference between room temperature and set temperature during operation

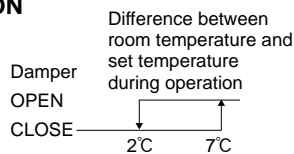

Indoor fan motor (Lower) in HEAT OPERATION

Indoor coil thermistor temperature

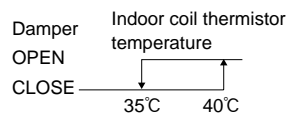

- As for indoor fan motor (upper), refer to "Indoor fan speed control (9-1.2, 9-2.2, 9-3.2)" and "INDOOR FAN MOTOR CONTROL (9-5)."

(10) EMBEDDING THE INDOOR UNIT IN A WALL

- When installing a grating, use a grating with narrow upper and lower horizontal bars so that the airflow from the upper and lower air outlets does not contact the bars. If the horizontal bars will block the lower air outlet, use a stand, etc., to adjust the height of the indoor unit. If the upper or lower air outlet is blocked, the air conditioner will not be able to cool or warm the room well.
- Do not block the receiver with the grating. Otherwise, the grating will interfere with the remote controller signal and significantly reduce the distance and area (angle) from which the signals can be received.
- Use a grating with vertical bars, etc., that has at least 75% open area. If the grating has horizontal bars or if the open area is less than 75%, performance could be reduced.
- When the indoor unit is embedded in a wall (built-in), it will take more time to reach the set temperature.

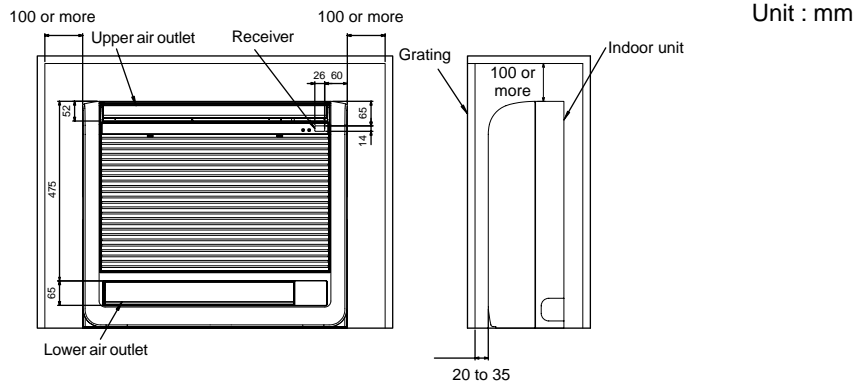

EMBEDDED INDOOR UNIT SETTING (MUST BE PERFORMED)

- When embedding the indoor unit in a wall, restrict the movement of the horizontal vane for the upper air outlet so that it only operates horizontally.
- If this setting is not performed, heat will build up in the wall and the room will not be cooled or warmed properly.
- Cut the wires on the left and right sides of JRFBL using a pair of nippers, etc., as shown below.

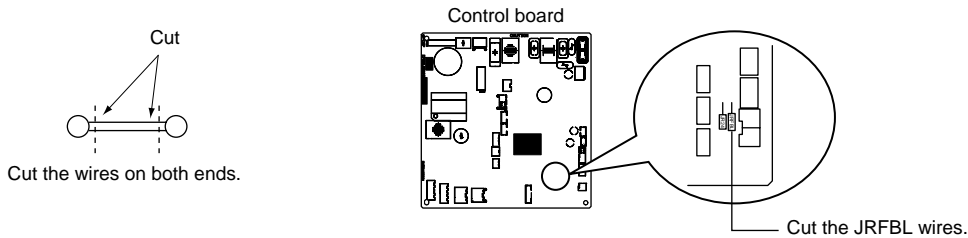

(11) ECONO COOL () operation (ECONOMical operation)

When ECONO COOL button is pressed in COOL mode, set temperature is automatically set 2°C higher.

Also the horizontal vane swings in various cycle according to the temperature of indoor heat exchanger(indoor coil thermostat).

SWING operation makes you feel cooler than set temperature. So, even though the set temperature is higher, the air conditioner can keep comfort. As a result, energy can be saved.

ECONO COOL operation is cancelled when ECONO COOL button is pressed once again or VANE CONTROL button is pressed or change to other operation mode.

<SWING operation>

In swing operation of ECONO COOL operation mode, the initial air flow direction is adjusted to "Horizontal". According to the temperature of indoor coil thermistor RT12 at starting of this operation, next downward blow time is decided. Then when the downward blow has been finished, next horizontal blow time is decided.

For initial 10 minutes the swing operation is performed in table G~H for quick cooling.

Also, after 10 minutes when the difference of set temperature and room temperature is more than 2°C, the swing operation is performed in table D~H for more cooling.

The air conditioner repeats the swing operation in various cycle as follows.

	Temperature of indoor coil thermistor RT12	Downward blow time (second)	Horizontal blow time (second)
A	15°C or less	2	23
B	15°C to 17°C	5	20
C	17°C to 18°C	8	17
D	18°C to 20°C	11	14
E	20°C to 21°C	14	11
F	21°C to 22°C	17	8
G	22°C to 24°C	20	5
H	more than 24°C	23	2

9-8. i-save OPERATION

1. How to set i-save operation

To start i-save operation:

- Press OPERATE/STOP(ON/OFF) button to start the air conditioner.
- Press OPERATION SELECT button to select COOL or HEAT mode.
i-save operation can only be set during cooling or heating operation (Not available in dry operation or auto mode operation).
- Press i-save button.

The operation indicator lamp on the right side of the indoor unit lights in orange.

To set the temperature, fan speed, and air flow direction for i-save operation:

- Press the temperature buttons to set the desired temperature.
- Press VANE CONTROL button to set the desired air flow direction.
- Press FAN SPEED CONTROL button to set the desired fan speed.

The next time i-save button is pressed, the air conditioner starts operating with the above settings for temperature, fan speed, and air flow direction.

To change the settings, repeat steps(1)–(3).

NOTE:

- ECONO COOL operation can be set together with COOL mode for i-save operation.
- Timer operation can be used even if i-save operation is set.

2. cancel

Press i-save button again.

i-save operation can also be cancelled by pressing OPERATION SELECT button to change the operation mode.

i-save operation has been successfully cancelled if the operation indicator lamp on the right side of the indoor unit turns off or changes from orange to green.

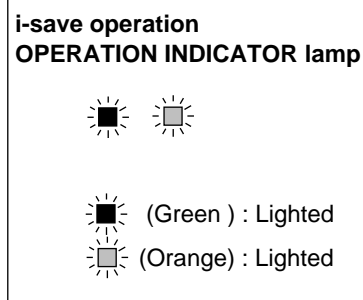

Usage of i-save operation:

1. Using as a low-energy mode

i-save operation can be used as a low-energy mode by setting the temperature 2–3°C warmer than the normal cooling temperature or 2–3°C cooler than the normal heating temperature. This is good to use if a room is unoccupied or while you are sleeping.

■ Before leaving the room unoccupied:

- Press i-save button to switch to the low-energy mode before leaving the room.
- When you return to the room, the temperature will not be too hot or too cold.
- Press i-save button again and the air conditioner will operate with the normal settings for temperature, fan speed, and air flow direction for a comfortable, air-conditioned environment.

■ Before sleeping:

- Before going to sleep, press i-save button, and then go to your bedroom.
- While you are sleeping, the room will be air-conditioned using the low-energy mode until the following morning.
- In the morning, press i-save button again, and the air conditioner will operate with the normal settings for temperature, fan speed, and air flow direction. The set room temperature will be obtained quicker than if the air conditioner was stopped while you were sleeping.

2. Using as a mode for frequent settings

If you often switch between two groups of settings for temperature, fan speed, and air flow direction in the same operation mode, save one group of settings using i-save button. This will allow you to select the desired group of settings simply by pressing i-save button, avoiding the troublesome remote controller operations.





9-9. TIMER OPERATION

1. How to set the timer





- (1) Press OPERATE/STOP (ON/OFF) button to start the air conditioner.
- (2) Check that the current time is set correctly.

NOTE : Timer operation will not work without setting the current time. Initially “AM0:00” blinks at the current time display of TIME MONITOR, so set the current time correctly with CLOCK SET button.

ON timer setting

- (1) Press ON-TIMER button () to set ON timer.
Each time the button is pressed, ON timer mode alternates between ON and OFF.
- (2) Set the time of the timer using TIME SET buttons ( and ).
Each time FORWARD button () is pressed, the set time increases by 10 minutes; each time BACKWARD button () is pressed, the set time decreases by 10 minutes.

OFF timer setting

- (1) Press OFF-TIMER button () to set OFF timer.
Each time the button is pressed, OFF timer mode alternates between ON and OFF.
- (2) Set the time of the timer using TIME SET buttons ( and ).
Each time FORWARD button () is pressed, the set time increases by 10 minutes; each time BACKWARD () button is pressed, the set time decreases by 10 minutes.

2. Cancel

TIMER setting can be cancelled with ON/OFF TIMER buttons.

To cancel ON timer, press ON-TIMER button ().

To cancel OFF timer, press OFF-TIMER button ().

TIMER is cancelled and the display of set time disappears.

PROGRAM TIMER

- The OFF timer and ON timer can be used in combination. The timer of the set time that is reached first will operate first.
- “↑” and “↓” display shows the order of the OFF timer and the ON timer operation.

(Example 1) The current time is 8:00 PM.

The unit turns off at 11:00 PM, and on at 6:00 AM.

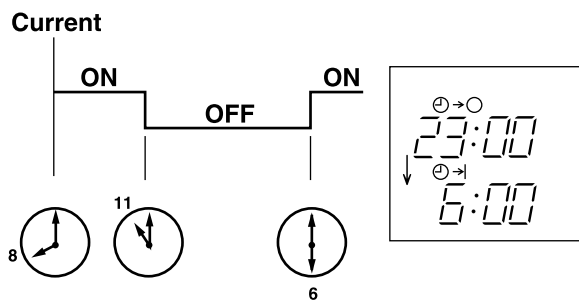

(Example 2) The current time is 11:00 AM.

The unit turns on at 5:00 PM, and off at 9:00 PM.

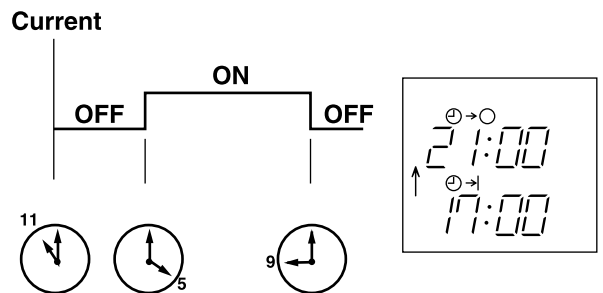

NOTE : If the main power is turned off or a power failure occurs while AUTO START/STOP timer is active, the timer setting is cancelled. As these models are equipped with an auto restart function, the air conditioner starts operating with timer cancelled when power is restored.

9-10. EMERGENCY / TEST OPERATION

In case of test run operation or emergency operation, use EMERGENCY OPERATION switch on the front of the indoor unit. Emergency operation is available when the remote controller is missing, has failed or the batteries of the remote controller run down. The unit will start and OPERATION INDICATOR lamp will light.

The first 30 minutes of operation is the test run operation. This operation is for servicing. The Indoor fan speed runs at High speed and the system is in continuous operation (The thermostat in ON).

After 30 minutes of test run operation, the system shifts to EMERGENCY COOL / HEAT MODE with a set temperature of 24°C. The fan speed shifts to Med.

The coil frost prevention works even in emergency operation, and defrosting too.

In the test run or emergency operation, the horizontal vane operates in VANE AUTO (@) mode.

Emergency operation continues until EMERGENCY OPERATION switch is pressed once or twice or the unit receives any signal from the remote controller. In case of latter, normal operation will start.

NOTE : Do not press EMERGENCY OPERATION switch during normal operation.



Operation mode	COOL	HEAT
Set temperature	24°C	24°C
Fan speed	Medium	Medium
Horizontal vane	Auto	Auto

- The following indication does not depend on the shape of lamp.

OPERATION INDICATOR lamp

- Press once <Cool> Lighted
 Not lighted
- Press again <Heat>
- Press once again <Stop>

10

MSZ-HA MICROPROCESSOR CONTROL

MSZ-HA25VA MUZ-HA25VA
MSZ-HA35VA MUZ-HA35VA

WIRELESS REMOTE CONTROLLER

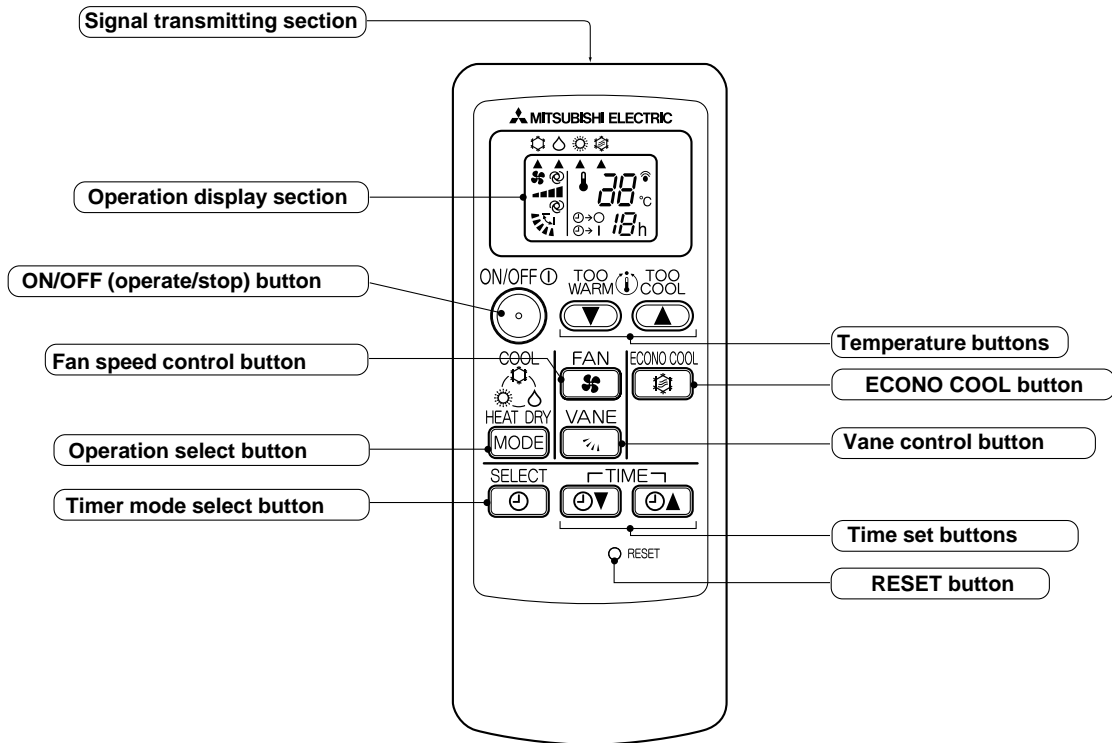

Once the operation mode is set, the same operation mode can be repeated by simply turning OPERATE/STOP (ON/OFF) button ON.

Indoor unit receives the signal with a beep tone.

When the system turns off, 3-minute time delay will operate to protect system from overload and compressor will not restart for 3 minutes.

INDOOR UNIT DISPLAY SECTION

Operation Indicator lamp

The operation indicator at the right side of the indoor unit indicates the operation state.

•The following indication applies regardless of shape of the indicator.

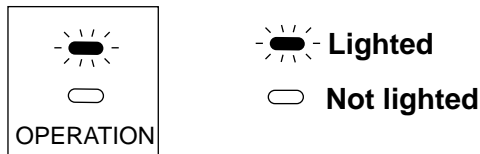

Indication	Operation state	Difference between target temperature and room temperature
	This shows that the air conditioner is operating to reach the target temperature. Please wait until the target temperature is obtained.	Approx. 2 °C or more
	This shows that the room temperature is approaching the target temperature.	Approx. 2 °C or less

10-1. COOL (❄) OPERATION

- (1) Press OPERATE/STOP(ON/OFF) button.
OPERATION INDICATOR lamp of the indoor unit turns on with a beep tone.
- (2) Select COOL mode with OPERATION SELECT button.
- (3) Press TEMPERATURE buttons (TOO WARM or TOO COOL button) to select the desired temperature.
The setting range is 16 ~ 31°C

1. Thermostat control

Thermostat is ON or OFF by difference between room temperature and set temperature

Initial temperature difference	Thermostat	Set temperature
Room temperature minus set temperature : -1.0 °C or more	ON	
Room temperature minus set temperature : less than -1.0 °C	OFF	

Difference between room temperature and set temperature during operation.

2. Indoor fan speed control

Indoor fan operates continuously at the set speed by FAN SPEED CONTROL button regardless of the thermostat's OFF-ON.
In AUTO the fan speed is as follows.

Initial temperature difference	Fan speed	Difference between room temperature and set temperature during operation
Room temperature minus set temperature : 1.7 °C or more	High	
Room temperature minus set temperature : Between 1 and 1.7 °C	Med.	
Room temperature minus set temperature : less than 1 °C	Low	

3. Coil frost prevention

Temperature control

When indoor coil thermistor detects following temperature for 90 seconds, operational frequency of compressor is controlled according to the following table.

Temperature of indoor coil thermistor	Operation frequency
10°C or more	Normal (variable)
8°C to 10°C	Raise 6Hz
6°C to 8°C	Fixed
3°C to 6°C	Lower 3Hz
3°C or less	Lower 6Hz Compressor is turned OFF for 5 minutes when temperature of indoor coil thermistor continues 3°C or less for 5 minutes or more.

The indoor fan maintains the actual speed of the moment.

10-2. DRY (△) OPERATION

- (1) Press OPERATE/STOP(ON/OFF) button.
OPERATION INDICATOR lamp of the indoor unit turns on with a beep tone.
- (2) Select DRY mode with OPERATION SELECT button.
- (3) The microprocessor reads the room temperature and determines the set temperature.
Set temperature is as shown on the right chart.

The system for dry operation uses the same refrigerant circuit as the cooling circuit. The compressor and the indoor fan are controlled by the room temperature. By such controls, indoor flow amounts will be reduced in order to lower humidity without much room temperature decrease.

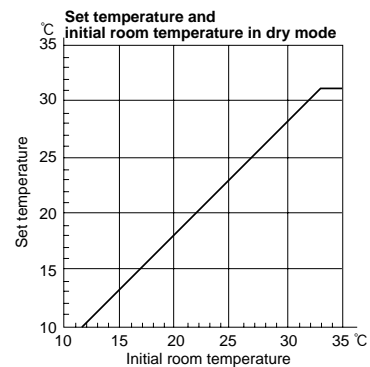

Difference between room temperature and set temperature during operation

1. Thermostat control

Thermostat is ON or OFF by difference between room temperature and set temperature.

Initial temperature difference	Thermostat	Set temperature
Room temperature minus set temperature : -1.0 °C or more	ON	
Room temperature minus set temperature : less than -1.0 °C	OFF	

2. Indoor fan speed control

Indoor fan operates at the set speed by FAN SPEED CONTROL button. When thermostat OFF (compressor OFF) fan speed becomes Very Low. In AUTO the fan speed is as follows.

Initial temperature difference	Fan speed	Difference between room temperature and set temperature during operation
Room temperature minus set temperature : 1.7 °C or more	High	
Room temperature minus set temperature : Between 1 and 1.7 °C	Med.	
Room temperature minus set temperature : less than 1 °C	Low	

3. Coil frost prevention

Coil frost prevention is as same as COOL mode. (10-1.3.)

The indoor fan maintains the actual speed of the moment.

10-3. HEAT () OPERATION

- (1) Press OPERATE/STOP(ON/OFF) button.
OPERATION INDICATOR lamp of the indoor unit turns on with a beep tone.
- (2) Select HEAT mode with OPERATION SELECT button.
- (3) Press TEMPERATURE buttons (TOO WARM or TOO COOL button) to select the desired temperature.
The setting range is 16 ~ 31°C.

Difference between room temperature and set temperature during operation

1. Thermostat control

Thermostat is ON or OFF by difference between room temperature and set temperature.

	Initial temperature difference	Thermostat	Set temperature
Room temperature minus set temperature : less than 2.0 °C		ON	
Room temperature minus set temperature : 2.0 °C or more.....		OFF	

2. Indoor fan speed control

- (1) Indoor fan operates at the set speed by FAN SPEED CONTROL button.
In Auto the fan speed is as follows.

	Initial temperature difference	Fan speed	Difference between room temperature and set temperature during operation
Set temperature minus room temperature: 2 °C or more.....		High	
Set temperature minus room temperature: Between 0.2 and 2 °C		Med.	
Set temperature minus room temperature: less than 0.2 °C		Low	

- (2) Cold air prevention control

- ① When the compressor is not operating,
 - (I) if the temperature of room temperature thermistor RT11 is less than 19°C, the fan stops.
 - (II) if the temperature of room temperature thermistor RT11 is 19°C or more and
 - (i) if the temperature of RT12 is less than 0°C, the fan stops.
 - (ii) if the temperature of RT12 is 0°C or more, the fan operates at Very Low.
- ② When the compressor is operating,
 - (I) if the temperature of RT12 is 40°C or more, the fan operates at set speed.
 - (II) if the temperature of RT12 is less than 40°C and
 - (i) if heating operation starts after defrosting, the fan stops.
 - (ii) if the temperature of room temperature thermistor RT11 is 19°C or less, the fan stops.
 - (iii) if the temperature of room temperature thermistor RT11 is more than 19°C, the fan operates at Very Low.

NOTE : When 3 minutes have passed since the compressor started operation, this control is released regardless of the temperature of RT11 and RT12.

3. High pressure protection

In HEAT operation the indoor coil thermistor detects the temperature of the indoor heat exchanger. The compressor operational frequency is controlled to prevent the condensing pressure from increasing excessively.

4. Overload starting

When the room temperature thermistor RT11 reads 18°C or more, the compressor runs with its maximum frequency regulated for 10 minutes after the start-up.

5. Defrosting

- (1) Starting conditions of defrosting

When the following conditions a) ~ c) are satisfied, the defrosting starts.

- a) The defrost thermistor reads -3°C or less.
- b) The cumulative operation time of the compressor has reached any of the set values* (40, 45, 55, 65, 75, 85, 95, 105, 115, 125, 150 minutes).
- c) More than 5 minutes have passed since the start-up of the compressor.

* Set value of compressor operation time(hereinafter referred to as defrost interval)

This is decided by the temperature of defrost thermistor and ambient temperature thermistor, the previous defrosting time. For example, the first defrost interval is 40 minutes long, and the second is 45 minutes long. The third and subsequent intervals are set to be longer, and less frequent, depending on defrosting time.

The third and subsequent defrost intervals follow any of the three patterns ...5 or 10 to 20 minutes longer, the same, or 5 or 10 to 20 minutes shorter compared with the previous defrost interval ... with the longest 125 minutes and the shortest 40 minutes.

- (2) Releasing conditions of defrosting

Defrosting is released when any of the following conditions is satisfied:

- a) The defrost thermistor continues to read 5°C or more for 30 seconds.
- b) Defrosting time has exceeded 10 minutes.
- c) Any other mode than HEAT mode is set during defrosting.



Time chart of defrosting in HEAT mode (reverse type)

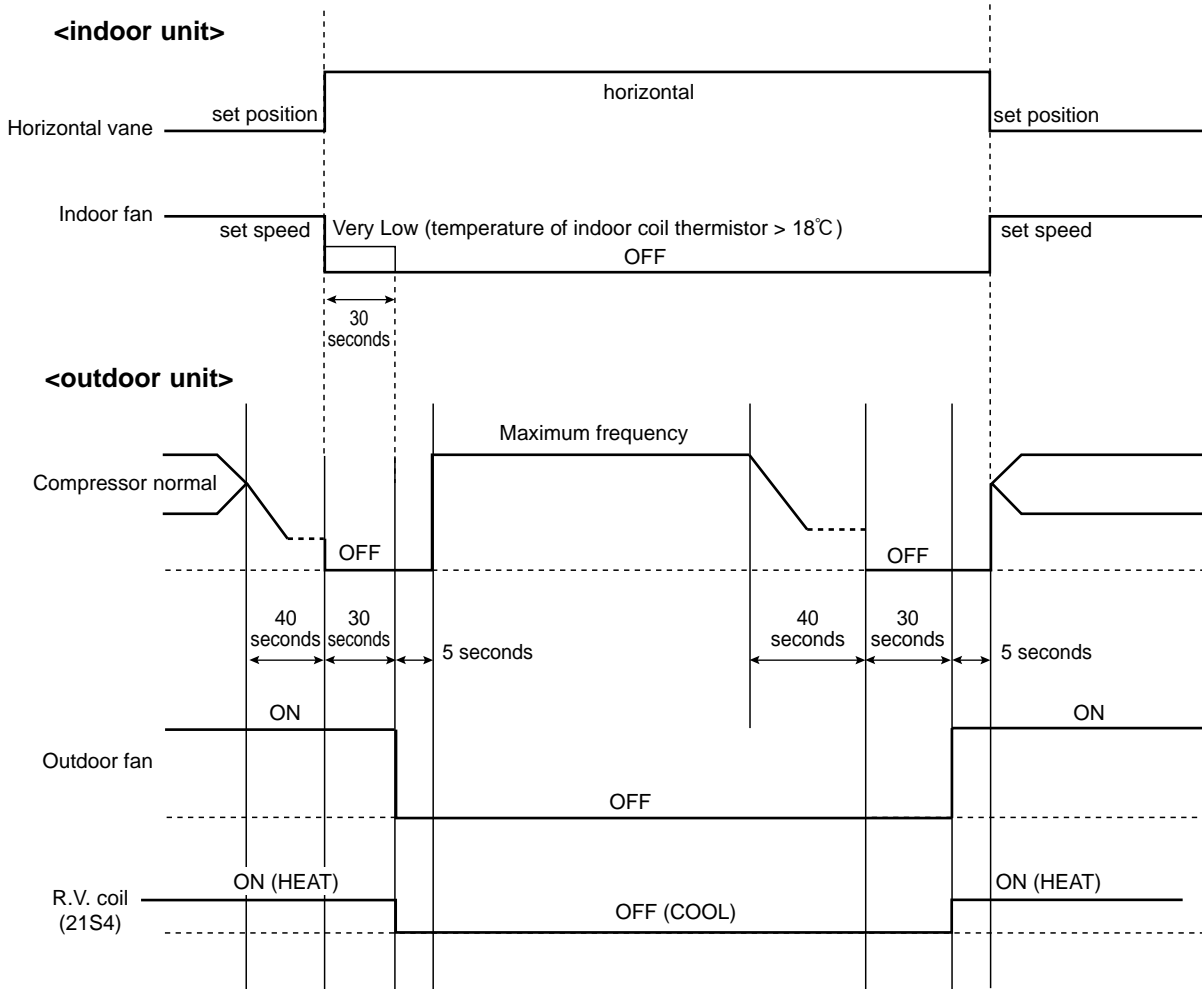

10-4. INDOOR FAN MOTOR CONTROL

(1) Rotational frequency feedback control

The indoor fan motor is equipped with a rotational frequency sensor, and outputs signal to the microprocessor to feedback the rotational frequency. Comparing the current rotational frequency with the target rotational frequency (Super High, High, Med., Low), the microprocessor adjusts fan motor electric current to make the current rotational frequency close to the target rotational frequency. With this control, when the fan speed is switched, the rotational frequency changes smoothly.

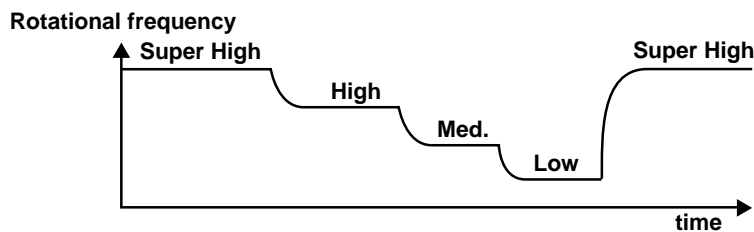

(2) Fan motor lock-up protection

When the rotational frequency feedback signal has not output for 12 seconds, (or when the microprocessor cannot detect the signal for 12 seconds) energizing to the fan motor is stopped. Then the microprocessor retries detection 3 times every 30 seconds. If the microprocessor still cannot detect the signal, the fan motor is regarded locked-up. When the fan motor lock-up, POWER lamp flashes on and off to show the fan motor abnormality.

10-5. AUTO VANE OPERATION

1. Horizontal vane

(1) Vane motor drive

These models are equipped with a stepping motor for the horizontal vane. The rotating direction, speed, and angle of the motor are controlled by pulse signals (approx. 12V) transmitted from indoor microprocessor.

(2) The horizontal vane angle and mode change as follows by pressing VANE CONTROL button.

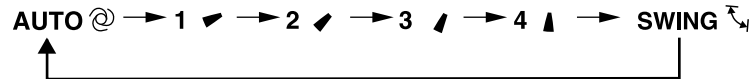

(3) Positioning

The vane presses the vane stopper once to confirm the standard position and then moves to the set angle. Confirming of standard position is performed in case of follows.

(a) When the operation starts or finishes (including timer operation).

(b) When the test run starts.

(4) VANE AUTO (Ⓐ) mode

The microprocessor automatically determines the vane angle and operation to make the optimum room temperature distribution.

COOL and DRY operation

Vane angle is fixed to Horizontal position.

HEAT operation

Vane angle is fixed to Angle 4.

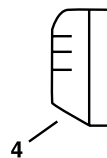
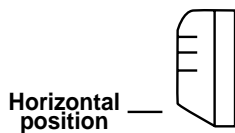

(5) STOP (operation OFF) and ON-TIMER standby

When the following cases occur, the horizontal vane returns to the closed position.

(a) When OPERATE/STOP (ON/OFF) button is pressed (POWER OFF).

(b) When the operation is stopped by the emergency operation.

(c) When ON-TIMER is ON standby.

(6) Dew prevention

During COOL or DRY operation with the vane angle at Angle 2 ~ 4 when the compressor cumulative operation time exceeds 1 hour, the vane angle automatically changes to Angle 1 for dew prevention.

(7) SWING MODE (Ⓕ)

By selecting SWING mode with VANE CONTROL button, the horizontal vane swings vertically. The remote controller displays "Ⓕ". SWING mode is cancelled when VANE CONTROL button is pressed once again.

(8) Cold air prevention in HEAT operation.

When any of the following conditions occurs in HEAT operation, the vane angle changes to Horizontal position automatically to prevent cold air blowing on users.

① Compressor is not operating.



② Defrosting is performed.

③ Indoor coil thermistor RT12 reads 24°C or below.

④ Indoor coil thermistor RT12 temperature is raising from 24°C or below, but it does not exceed 39°C.

⑤ For about 3 minutes after compressor starts.

(9) To change the air flow direction not to blow directly onto your body.

To change the air flow direction	When to use this function?	COOL/DRY	HEAT
Pressing and holding VANE CONTROL button for 2 seconds or more causes the horizontal vane to reverse and move to horizontal position.  Horizontal position	Use this function if you don't want the air from the indoor unit to blow directly onto your body. <ul style="list-style-type: none"> Depending on the shape of the room, the air may blow directly onto your body. Press VANE CONTROL button again to return the vane to the previously-set position. 	The air conditioner starts the cooling or drying operation approx. 3 minutes after the vane has moved to the horizontal position. <ul style="list-style-type: none"> When VANE CONTROL button is pressed again, the vane returns to the previously-set position and the air conditioner starts the cooling or drying operation in approx. 3 minutes. 	The air conditioner starts heating operation approx. 3 minutes after the vane has moved to the horizontal position. <ul style="list-style-type: none"> Sometimes the area around your feet may not warm. To warm the area around the feet, set the horizontal vane to  (AUTO) or the downward-blowing position. When VANE CONTROL button is pressed again, the vane returns to the previously-set position and the air conditioner starts the heating operation in approx. 3 minutes.

NOTE:

- If you make the air flow not to blow directly onto your body by pressing VANE CONTROL button, the compressor stops for 3 minutes even during the operation of the air conditioner.
- The air conditioner operates with decreased air flow until the compressor turns on again.

(10) ECONO COOL () operation (ECONOMical operation)

When ECONO COOL button is pressed in COOL mode, set temperature is automatically set 2°C higher.

Also the horizontal vane swings in various cycle according to the temperature of indoor heat exchanger (RT12).

SWING operation makes you feel cooler than set temperature. So, even though the set temperature is higher, the air conditioner can keep comfort. As a result, energy can be saved.

ECONO COOL operation is cancelled when ECONO COOL button is pressed once again or VANE CONTROL button is pressed or change to other operation mode.

<SWING operation>

In swing operation of ECONO COOL operation mode, the initial air flow direction is adjusted to "Horizontal".

According to the temperature of indoor coil thermistor RT12 at starting of this operation, next downward blow time is decided. Then when the downward blow has been finished, next horizontal blow time is decided.

For initial 10 minutes the swing operation is performed in table G~H for quick cooling.

Also, after 10 minutes when the difference of set temperature and room temperature is more than 2°C, the swing operation is performed in table D~H for more cooling.

The air conditioner repeats the swing operation in various cycle as follows.

	Temperature of indoor coil thermistor RT12	Downward blow time (second)	Horizontal blow time (second)
A	15°C or less	2	23
B	15°C to 17°C	5	20
C	17°C to 18°C	8	17
D	18°C to 20°C	11	14
E	20°C to 21°C	14	11
F	21°C to 22°C	17	8
G	22°C to 24°C	20	5
H	more than 24°C	23	2

10-6. TIMER OPERATION (ON/OFF TIMER)



1. How to set the timer

(1) Press OPERATE/STOP (ON/OFF) button to start the air conditioner.

(2) Select the timer mode by pressing the  button during operation.

Each time this button is pressed, the timer mode is changed in sequence:

☉→○ (OFF TIMER) → ☉→| (ON TIMER) → TIMER RELEASE

(3) Set the time of the timer using the   button.

Each time this button is pressed, the set time increase or decrease by 1 hour to 12 hours.

2. To release the timer

Press the  button until ☉→○ (OFF TIMER) and ☉→| (ON TIMER) are not displayed.

NOTE :

- The OFF TIMER and the ON TIMER cannot be set at the same time.
- The displayed time is the time remaining and will decrease in 1-hour increments as time passes.

10-7. EMERGENCY/TEST OPERATION

In case of test run operation or emergency operation, use EMERGENCY OPERATION switch on the front of the indoor unit. Emergency operation is available when the remote controller is missing, has failed or the batteries of the remote controller run down. The unit will start and OPERATION INDICATOR lamp will light.

The first 30 minutes of operation is the test run operation. This operation is for servicing. The Indoor fan speed runs at High speed and the system is in continuous operation (The thermostat in ON).

After 30 minutes of test run operation, the system shifts to EMERGENCY COOL / HEAT MODE with a set temperature of 24°C. The fan speed shifts to Med.

The coil frost prevention works even in emergency operation, and defrosting too.

In the test run or emergency operation, the horizontal vane operates in VANE AUTO (@) mode.

Emergency operation continues until EMERGENCY OPERATION switch is pressed once or twice or the unit receives any signal from the remote controller. In case of latter, normal operation will start.

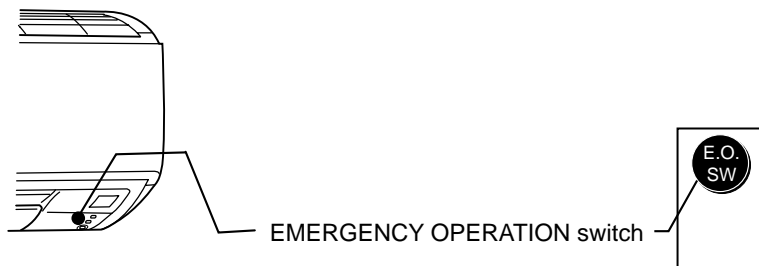

NOTE : Do not press EMERGENCY OPERATION switch during normal operation.



Operation mode	COOL	HEAT
Set temperature	24°C	24°C
Fan speed	Medium	Medium
Horizontal vane	Auto	Auto

The operation mode is indicated by the Operation Indicator lamp on the indoor unit as following

Operation Indicator lamp

EMERGENCY COOL		● Lighted ○ Not lighted
EMERGENCY HEAT		
STOP		

10-8. INVERTER SYSTEM CONTROL

10-8-1. Inverter main power supply circuit

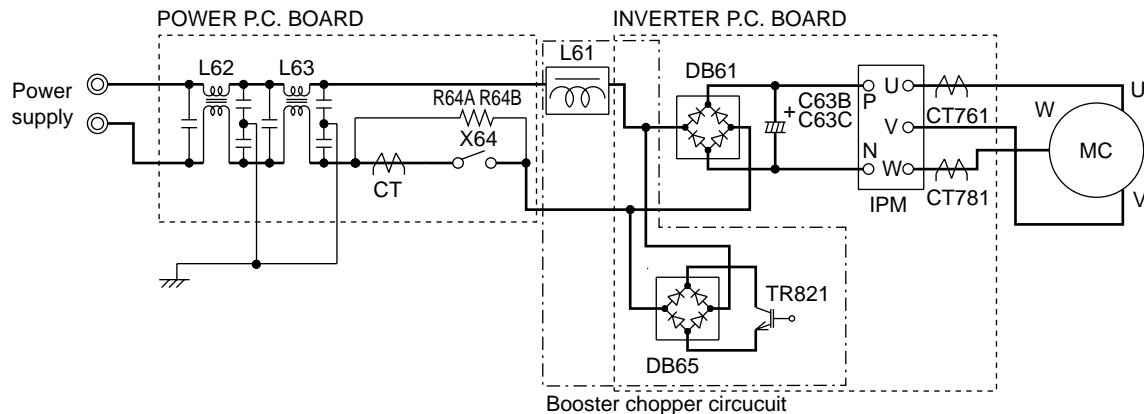

Function of main parts

SYMBOL	NAME	FUNCTION	
IPM	INTELLIGENT POWER MODULE	It supplies three-phase AC power to compressor.	
C63B/C63C	SMOOTHING CAPACITOR	It stabilizes the DC voltage.	
CT761/CT781	CURRENT TRANSFORMER	It measures the current of the compressor motor.	
CT	CURRENT TRANSFORMER	It measures the value of current which is supplied to the main power supply circuit.	
DB61	DIODE MODULE	It converts the AC voltage to DC voltage.	
R64A, R64B	CURRENT-LIMITING RESISTOR	It absorbs the rush current not to run into the main power supply circuit when the electricity turns ON.	
X64	RELAY	It short-circuits the resistance which restricts rush current during the normal operation after the compressor startup.	
DB65	DIODE MODULE	Booster chopper circuit	It improves power factor. It rectifies AC and controls its voltage.
TR821	SWITCHING POWER TRANSISTOR		
L61	REACTOR		

10-8-2. Outline of main power supply circuit

1. At the start of operation

Main power supply circuit is formed when X64 (Relay) is turned ON at compressor startup.

To prevent rush current from running into the circuit when power supply is turned ON, R64A and R64B (Current-limiting resistor) are placed in sub circuit.

2. At normal operation

- ① When AC runs into POWER P.C. board, its external noise is eliminated in the noise filter circuit.
- ② After noise is eliminated from AC, it is rectified to DC by DB61 (Diode module).
- ③ DC voltage, to which AC has been rectified by process ②, is stabilized by C63B and C63C (Smoothing capacitor) and supplied to IPM (Intelligent power module).
- ④ DC voltage, which has been stabilized in process ③, is converted to three-phase AC by IPM and supplied to compressor.
- ⑤ CT761 and CT781 (Current Transformer), which are placed in the power supply circuit to compressor, are used to measure the value of phase current and locate the polar direction of rotor with algorithm. PWM (Pulse width modulation) controls impressed voltage and frequency with those information.

3. Purpose of PAM adoption

PAM : Pulse Amplitude Modulation

PAM has been adopted for the efficiency improvement and the adaptation to IEC harmonic current emission standard.

Outline of simple partial switching method

In conventional inverter models, diode module rectifies AC voltage to DC voltage, smoothing capacitor makes its DC waveform smooth, and IPM converts its DC voltage to imitated AC voltage again in order to drive the compressor motor. However, it has been difficult to meet IEC harmonic current emission standard by above circuit because harmonic gets generated in the input current waveform and power factor gets down. The simple partial switching method with PAM, which has been adopted this time, places and utilizes the booster chopper circuit (L61, DB65 and TR821) before rectifying AC voltage in the general passive-method converter circuit. As harmonic gets suppressed and the peak of waveform gets lower by adding booster chopper circuit as mentioned above and by synchronizing the timing of one-time switching with the zero-cross point of waveform, the input current waveform can be improved and the requirement of IEC harmonic current emission standard can be satisfied. Since the switching times is just once by synchronizing with the zero cross point, this simple partial switching method has the feature of lower energy loss compared to active filter method. In addition, output and efficiency is enhanced by combining with vector-controlled inverter in order to boost the voltage of power supplied to IPM.

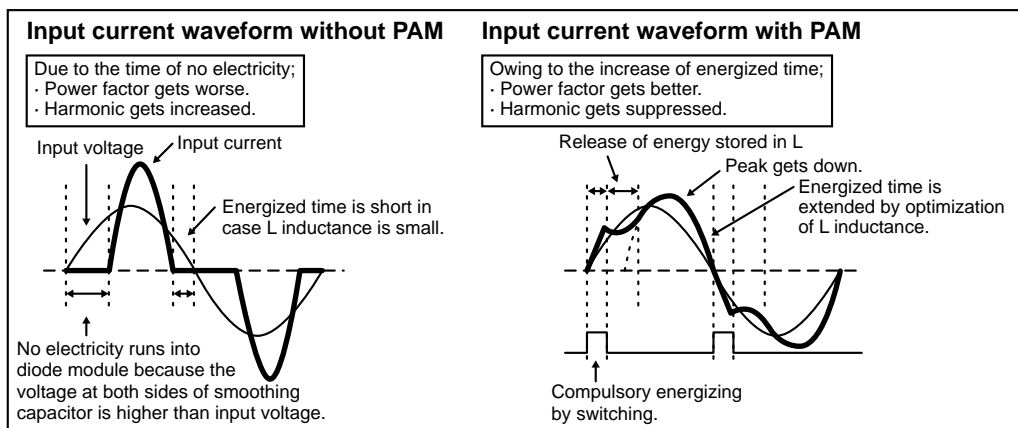

4. Intelligent power module

IPM consists of the following components

- IGBT (x6) : Converts DC waveform to three-phase AC waveform and outputs it.
- Drive Circuit : Drives transistors.
- Protection circuit : Protects transistors from overcurrent.

Since the above components are all integrated in IPM, IPM has a merit to make the control circuit simplify and miniaturize.

5. Smoothing capacitor

C63B and C63C stabilize the DC voltage and supply it to IPM.

6. Elimination of electrical noise

Noise filter circuit, which is formed by *CMC COILS capacitors placed on the POWER P.C. board, eliminates electrical noise of AC power that is supplied to main power supply circuit. And this circuit prevents the electrical noise generated in the inverter circuit from leaking out.

*CMC COILS; Common mode choke coils

Sine wave control

In these air conditioners, compressor equips brushless DC motor which doesn't have Hall element.

In short, the motor is sensorless. However, it's necessary to locate the polar direction of rotor in order to drive brushless DC motor efficiently. The general detection method of the polar direction for such a DC motor is to locate it from the voltage induced by unenergized stator.

Therefore, It is necessary to have a certain period of time in which the stator is being unenergized for the rotor position detection when the voltage of supplied power is impressed.

So the motor has been driven by square wave control (the conventional motor drive system) which energizes the motor only when the range of electrical angle is within 120° because it is forced to be unenergized within 30° at start & end of one heap in one waveform cycle (180°) when the voltage is impressed.

However, torque pulsation occurs at rotation in this method when the current-carrying phases are switched over to other phases in sequence. Therefore, sine wave control system is adopted for these air conditioners because it can make the phase-to-phase current waveform smoother (sine wave) in order to drive the motor more efficiently and smoothly.

10-8-3. Characteristics of sine wave control in case of brushless DC motor

- Although ordinary three-phase induction motor requires energy to excite the magnetic field of rotor, brushless DC motor doesn't need it. So, higher efficiency and torque are provided.
- This control provides the most efficient waveform corresponding to the rotation times of compressor motor.
- The rotation can be set to higher compared to the conventional motor drive system. So, the time in which air conditioner can be operated with energy saved is longer than conventional models. This can save annual electric consumption.
- Compared to square wave control, the torque pulsation is reduced at rotation so that the motor operates more quietly.
- Since response and efficiency of motor are enhanced in sine wave control, finer adjustment can be provided.

	DC Motor	AC Motor
Rotor	Permanent magnet is embedded.	Excited by magnetic field of stator
Rotor Position Signal	Necessary	Unnecessary

※ In brushless DC motor, permanent magnet is embedded in the rotor. Therefore, it doesn't require energy to excite the rotor like AC motor does. However, it's necessary to control the frequency of three-phase AC current supplied to the stator according to the polar direction of magnet embedded in the rotor so as to drive the motor efficiently. Controlling three-phase AC current frequency also means controlling the timing to switch the polarity of stator. Therefore, the polar direction of rotor needs to be detected.

10-8-4. Control Method of Rotation Times

Sine wave control makes the current transformers conduct real time detection of the value of the current running into the motor, locates the rotor position from the detected value, and decides if voltage should be impressed and if frequency should be changed.

Compared to the conventional control and rotor position detection method, sine wave control can provide finer adjustment of the voltage of supplied power. The value of the current running into the motor is determined by each motor characteristic.

10-9. OPERATIONAL FREQUENCY CONTROL OF OUTDOOR UNIT

1. Outline

The operational frequency is as following:

First, the target operational frequency is set based on the difference between the room temperature and the set temperature.

Second, the target operational frequency is regulated by discharge temperature protection, high pressure protection, electric current protection and overload protection and also by the maximum/minimum frequency.

2. Maximum/minimum frequency in each operation mode

Applied model	COOL		HEAT		DRY	
	Minimum frequency	Maximum frequency	Minimum frequency	Maximum frequency	Minimum frequency	Maximum frequency
MUZ-HA25VA	28	79	48	104	28	40
MUZ-HA35VA	28	98	45	101	28	58

※ The operation frequency in COOL mode is restricted the upper limit frequency after 0.5 ~ 1 hour as shown below for dew prevention.

It is rated frequency or less.

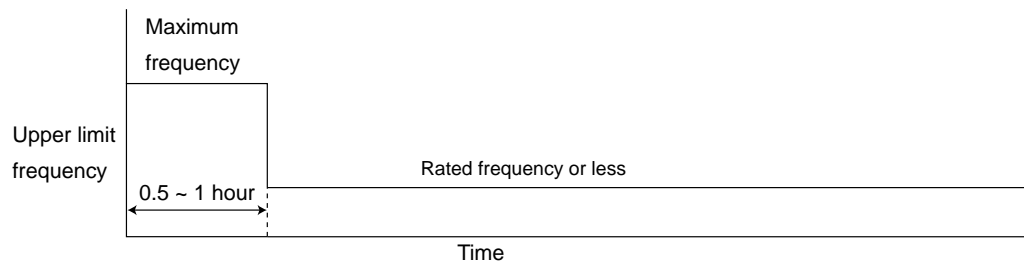

MSZ-GB50VA MUZ-GB50VA

WIRELESS REMOTE CONTROLLER

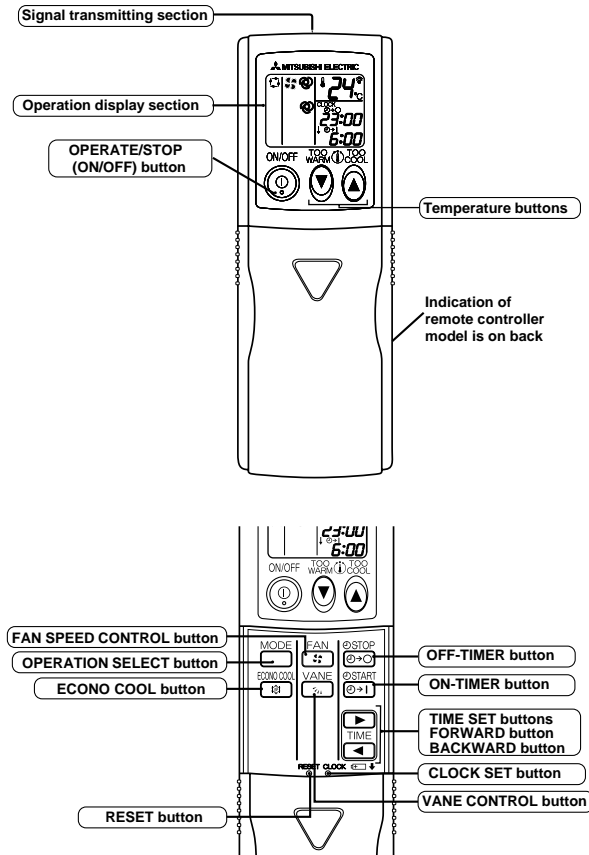

Once the operation mode is set, the same operation mode can be repeated by simply turning OPERATE/STOP (ON/OFF) button ON.

Indoor unit receives the signal with a beep tone.

When the system turns off, 3-minute time delay will operate to protect system from overload and compressor will not restart for 3 minutes.

INDOOR UNIT DISPLAY SECTION

Operation Indicator lamp

The operation indicator at the right side of the indoor unit indicates the operation state.

•The following indication applies regardless of shape of the indicator.

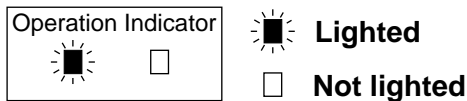

Indication	Operation state	Difference between target temperature and room temperature
	This shows that the air conditioner is operating to reach the target temperature. Please wait until the target temperature is obtained.	Approx. 2 °C or more
	This shows that the room temperature is approaching the target temperature.	Approx. 2 °C or less

11-1. COOL (❄) OPERATION

- (1) Press OPERATE/STOP(ON/OFF) button.
OPERATION INDICATOR lamp of the indoor unit turns on with a beep tone.
- (2) Select COOL mode with OPERATION SELECT button.
- (3) Press TEMPERATURE buttons (TOO WARM or TOO COOL button) to select the desired temperature.
The setting range is 16 ~ 31°C

1. Thermostat control

Thermostat is ON or OFF by difference between room temperature and set temperature

Initial temperature difference	Thermostat	Set temperature
Room temperature minus set temperature : -1.0 °C or more	ON	
Room temperature minus set temperature : less than -1.0 °C	OFF	

Difference between room temperature and set temperature during operation.

2. Indoor fan speed control

Indoor fan operates continuously at the set speed by FAN SPEED CONTROL button regardless of the thermostat's OFF-ON.
In AUTO the fan speed is as follows.

Initial temperature difference	Fan speed	Difference between room temperature and set temperature during operation
Room temperature minus set temperature : 1.7 °C or more	High	
Room temperature minus set temperature : Between 1 and 1.7 °C	Med.	
Room temperature minus set temperature : less than 1 °C	Low	

3. Coil frost prevention

Temperature control

When indoor coil thermistor detects following temperature for 90 seconds, operational frequency of compressor is controlled according to the following table.

Temperature of indoor coil thermistor	Operation frequency
10°C or more	Normal (variable)
8°C to 10°C	Raise 6Hz
6°C to 8°C	Fixed
3°C to 6°C	Lower 3Hz
3°C or less	Lower 6Hz Compressor is turned OFF for 5 minutes when temperature of indoor coil thermistor continues 3°C or less for 5 minutes or more.

The indoor fan maintains the actual speed of the moment.

4. Low outside temperature operation

If the outside temperature falls to 18°C or less during operation in COOL mode, the unit enters the low outside temperature operation mode.

<Operation>

- (1) If the unit enters the low outside temperature operation mode, the outside fan rotation speed gets slow down.
- (2) Even when the unit is in the "thermostat-off" status under the low outside temperature operation mode, the outside fan rotation does not stop.
- (3) Outside temperature detecting control
In this mode to detect the exact outside temperature the compressor turns OFF with the outdoor fan ON for 3 minutes once 1 hour; if the outside temperature rises over 18°C, the unit goes back to the normal COOL mode, and if the outside temperature is still 18°C or less, the unit stays in the low outside temperature operation mode.
- (4) Dew drop prevention
When the ambient temperature thermistor RT65 reads -12°C or less, as coil frost or dew drop from indoor unit may occur, the compressor turns OFF with the outdoor fan ON for prevention of them.

*Other protections work as well as in the normal COOL mode.

11-2. DRY (Δ) OPERATION

- (1) Press OPERATE/STOP(ON/OFF) button.
OPERATION INDICATOR lamp of the indoor unit turns on with a beep tone.
- (2) Select DRY mode with OPERATION SELECT button.
- (3) The microprocessor reads the room temperature and determines the set temperature. Set temperature is as shown on the right chart.

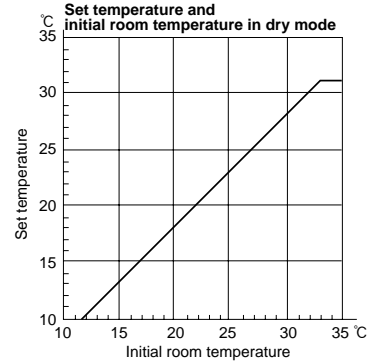

The system for dry operation uses the same refrigerant circuit as the cooling circuit. The compressor and the indoor fan are controlled by the room temperature.

By such controls, indoor flow amounts will be reduced in order to lower humidity without much room temperature decrease.

1. Thermostat control

Thermostat is ON or OFF by difference between room temperature and set temperature.

Initial temperature difference	Thermostat	Set temperature
Room temperature minus set temperature : $-1.0\text{ }^{\circ}\text{C}$ or more.....	ON	
Room temperature minus set temperature : less than $-1.0\text{ }^{\circ}\text{C}$	OFF	

Difference between room temperature and set temperature during operation

2. Indoor fan speed control

Indoor fan operates at the set speed by FAN SPEED CONTROL button. When thermostat OFF (compressor OFF) fan speed becomes Very Low.

In AUTO the fan speed is as follows.

Initial temperature difference	Fan speed	Difference between room temperature and set temperature during operation
Room temperature minus set temperature : $1.7\text{ }^{\circ}\text{C}$ or more	High	
Room temperature minus set temperature : Between 1 and $1.7\text{ }^{\circ}\text{C}$	Med.	
Room temperature minus set temperature : less than $1\text{ }^{\circ}\text{C}$	Low	

3. Coil frost prevention

Coil frost prevention is as same as COOL mode. (11-1.3.)

The indoor fan maintains the actual speed of the moment.

4. Low outside temperature operation

Low outside temperature operation is as same as COOL mode. (11-1.4.)

11-3. HEAT (\odot) OPERATION

- (1) Press OPERATE/STOP(ON/OFF) button.
OPERATION INDICATOR lamp of the indoor unit turns on with a beep tone.
- (2) Select HEAT mode with OPERATION SELECT button.
- (3) Press TEMPERATURE buttons (TOO WARM or TOO COOL button) to select the desired temperature.
The setting range is $16 \sim 31\text{ }^{\circ}\text{C}$.

1. Thermostat control

Thermostat is ON or OFF by difference between room temperature and set temperature.

Initial temperature difference	Thermostat	Set temperature
Room temperature minus set temperature : less than $2.0\text{ }^{\circ}\text{C}$	ON	
Room temperature minus set temperature : $2.0\text{ }^{\circ}\text{C}$ or more.....	OFF	

Difference between room temperature and set temperature during operation

2. Indoor fan speed control

- (1) Indoor fan operates at the set speed by FAN SPEED CONTROL button. In Auto the fan speed is as follows.

Initial temperature difference	Fan speed	Difference between room temperature and set temperature during operation
Set temperature minus room temperature: $2\text{ }^{\circ}\text{C}$ or more.....	High	
Set temperature minus room temperature: Between 0.2 and $2\text{ }^{\circ}\text{C}$	Med.	
Set temperature minus room temperature: less than $0.2\text{ }^{\circ}\text{C}$	Low	

- (2) Cold air prevention control

- ① When the compressor is not operating,
 - (I) if the temperature of room temperature thermistor RT11 is less than $19\text{ }^{\circ}\text{C}$, the fan stops.
 - (II) if the temperature of room temperature thermistor RT11 is $19\text{ }^{\circ}\text{C}$ or more and
 - (i) if the temperature of RT12 is less than $0\text{ }^{\circ}\text{C}$, the fan stops.
 - (ii) if the temperature of RT12 is $0\text{ }^{\circ}\text{C}$ or more, the fan operates at Very Low.
- ② When the compressor is operating,
 - (I) if the temperature of RT12 is $40\text{ }^{\circ}\text{C}$ or more, the fan operates at set speed.
 - (II) if the temperature of RT12 is less than $40\text{ }^{\circ}\text{C}$ and
 - (i) if heating operation starts after defrosting, the fan stops.
 - (ii) if the temperature of room temperature thermistor RT11 is $19\text{ }^{\circ}\text{C}$ or less, the fan stops.
 - (iii) if the temperature of room temperature thermistor RT11 is more than $19\text{ }^{\circ}\text{C}$, the fan operates at Very Low.

NOTE : When 3 minutes have passed since the compressor started operation, this control is released regardless of the temperature of RT11 and RT12.

3. High pressure protection

In HEAT operation the indoor coil thermistor detects the temperature of the indoor heat exchanger. The compressor operational frequency is controlled to prevent the condensing pressure from increasing excessively.

4. Overload starting

When the room temperature thermistor RT11 reads 18°C or more, the compressor runs with its maximum frequency regulated for 10 minutes after the start-up.

5. Defrosting

(1) Starting conditions of defrosting

When the following conditions a) ~ c) are satisfied, the defrosting starts.

a) The defrost thermistor reads -3°C or less.

b) The cumulative operation time of the compressor has reached any of the set values* (31, 35, 45, 55, 65, 75, 85, 95, 105, 115, 150 minutes).

c) More than 5 minutes have passed since the start-up of the compressor.

* Set value of compressor operation time(hereinafter referred to as defrost interval)

This is decided by the temperature of defrost thermistor and ambient temperature thermistor, the previous defrosting time. For example, the first defrost interval is 40 minutes long, and the second is 45 minutes long. The third and subsequent intervals are set to be longer, and less frequent, depending on defrosting time.

The third and subsequent defrost intervals follow any of the three patterns ...5 or 10 to 20 minutes longer, the same, or 5 or 10 to 20 minutes shorter compared with the previous defrost interval ... with the longest 125 minutes and the shortest 40 minutes.

(2) Releasing conditions of defrosting

Defrosting is released when any of the following conditions is satisfied:

a) The defrost thermistor continues to read 15°C or more for 30 seconds.

b) Defrosting time has exceeded 10 minutes.

c) Any other mode than HEAT mode is set during defrosting.

Time chart of defrosting in HEAT mode (reverse type)

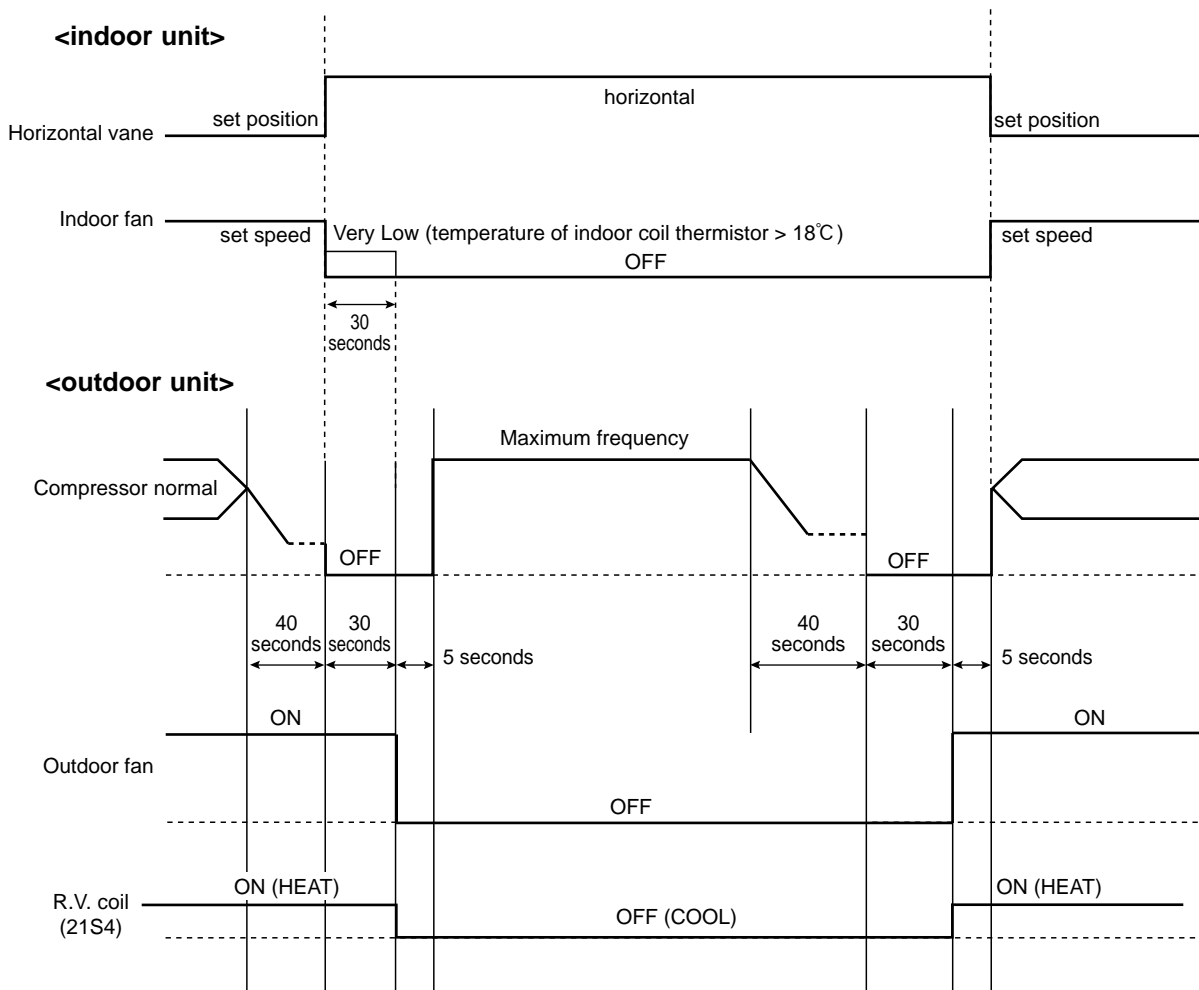

11-4. AUTO CHANGE OVER ... AUTO MODE OPERATION

Once desired temperature is set, unit operation is switched automatically between COOL and HEAT operation.

1. Mode selection

(1) Initial mode

At first indoor unit operates only indoor fan with outdoor unit OFF for 3 minutes to detect present room temperature. Following the conditions below, operation mode is selected.

- ① If the room temperature thermistor RT11 reads more than set temperature, COOL mode is selected.
- ② If the room temperature thermistor RT11 reads set temperature or less, HEAT mode is selected.

(2) Mode change

In case of the following conditions the operation mode is changed.

- ① COOL mode changes to HEAT mode when 15 minutes have passed with the room temperature 2 degrees below the set temperature.
- ② HEAT mode changes to COOL mode when 15 minutes have passed with the room temperature 2 degrees above the set temperature.

In the other cases than the above conditions, the present operation mode is continued.

NOTE1: Mode selection is performed when multi standby (refer to NOTE2) is released and the unit starts operation with ON-timer.

NOTE2: If two or more indoor units are operating in multi system, there might be a case that the indoor unit, which is operating in AUTO (□), cannot change over the other operating mode (COOL ↔ HEAT) and becomes a state of standby.

(3) Indoor fan control/ Vane control

As the indoor fan speed and the horizontal vane position depend on the selected operation mode, when the operation mode changes over, they change to the exclusive ones.

11-5. INDOOR FAN MOTOR CONTROL

(1) Rotational frequency feedback control

The indoor fan motor is equipped with a rotational frequency sensor, and outputs signal to the microprocessor to feedback the rotational frequency. Comparing the current rotational frequency with the target rotational frequency (Super High, High, Med., Low), the microprocessor adjusts fan motor electric current to make the current rotational frequency close to the target rotational frequency. With this control, when the fan speed is switched, the rotational frequency changes smoothly.

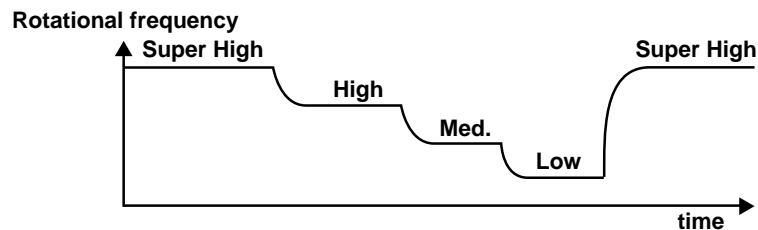

(2) Fan motor lock-up protection

When the rotational frequency feedback signal has not output for 12 seconds, (or when the microprocessor cannot detect the signal for 12 seconds) energizing to the fan motor is stopped. Then the microprocessor retries detection 3 times every 30 seconds. If the microprocessor still cannot detect the signal, the fan motor is regarded locked-up. When the fan motor lock-up, POWER lamp flashes on and off to show the fan motor abnormality.

11-6. OUTDOOR FAN MOTOR CONTROL

Fan speed is switched according to the compressor frequency.

Fan speed

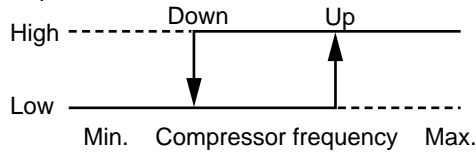

<Relation between compressor frequency and fan speed>

Mode	Fan speed	Compressor frequency(Hz)
COOL	Up	44
	Down	33
HEAT	Up	44
	Down	33

11-7. AUTO VANE OPERATION

1. Horizontal vane

(1) Vane motor drive

These models are equipped with a stepping motor for the horizontal vane. The rotating direction, speed, and angle of the motor are controlled by pulse signals (approx. 12V) transmitted from indoor microprocessor.

(2) The horizontal vane angle and mode change as follows by pressing VANE CONTROL button.

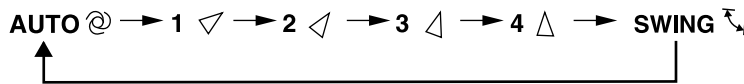

(3) Positioning

The vane presses the vane stopper once to confirm the standard position and then moves to the set angle.

Confirming of standard position is performed in case of follows.

- When the operation starts or finishes (including timer operation).
- When the test run starts.
- When multi-standby starts or finishes.

(4) VANE AUTO (@) mode

The microprocessor automatically determines the vane angle and operation to make the optimum room temperature distribution.

COOL and DRY operation

Vane angle is fixed to Horizontal position.

HEAT operation

Vane angle is fixed to Angle 4.

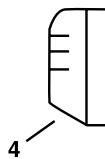
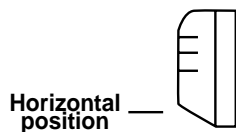

(5) STOP (operation OFF) and ON-TIMER standby

When the following cases occur, the horizontal vane returns to the closed position.

- When OPERATE/STOP (ON/OFF) button is pressed (POWER OFF).
- When the operation is stopped by the emergency operation.
- When ON-TIMER is ON standby.

(6) Dew prevention

During COOL or DRY operation with the vane angle at Angle 2 ~ 4 when the compressor cumulative operation time exceeds 1 hour, the vane angle automatically changes to Angle 1 for dew prevention.

(7) SWING MODE (冫)

By selecting SWING mode with VANE CONTROL button, the horizontal vane swings vertically. The remote controller displays " 冫 ". SWING mode is cancelled when VANE CONTROL button is pressed once again.



(8) Cold air prevention in HEAT operation.

When any of the following conditions occurs in HEAT operation, the vane angle changes to Horizontal position automatically to prevent cold air blowing on users.

- ① Compressor is not operating.
- ② Defrosting is performed.
- ③ Indoor coil thermistor RT12 reads 24°C or below.
- ④ Indoor coil thermistor RT12 temperature is raising from 24°C or below, but it does not exceed 39°C.
- ⑤ For about 3 minutes after compressor starts.

NOTE: When 2 or more indoor units are operated with multi outdoor unit, even if any indoor unit turns thermostat off, this control doesn't work in the indoor unit.

(9) To change the air flow direction not to blow directly onto your body.

To change the air flow direction	When to use this function?	COOL/DRY	HEAT
Pressing and holding VANE CONTROL button for 2 seconds or more causes the horizontal vane to reverse and move to horizontal position.  Horizontal position	Use this function if you don't want the air from the indoor unit to blow directly onto your body. <ul style="list-style-type: none"> • Depending on the shape of the room, the air may blow directly onto your body. • Press VANE CONTROL button again to return the vane to the previously-set position. 	The air conditioner starts the cooling or drying operation approx. 3 minutes after the vane has moved to the horizontal position. <ul style="list-style-type: none"> • When VANE CONTROL button is pressed again, the vane returns to the previously-set position and the air conditioner starts the cooling or drying operation in approx. 3 minutes. 	The air conditioner starts heating operation approx. 3 minutes after the vane has moved to the horizontal position. <ul style="list-style-type: none"> • Sometimes the area around your feet may not warm. To warm the area around the feet, set the horizontal vane to  (AUTO) or the downward-blowing position. • When VANE CONTROL button is pressed again, the vane returns to the previously-set position and the air conditioner starts the heating operation in approx. 3 minutes.

NOTE:

- If you make the air flow not to blow directly onto your body by pressing VANE CONTROL button, the compressor stops for 3 minutes even during the operation of the air conditioner.
- The air conditioner operates with decreased air flow until the compressor turns on again.

(10) ECONO COOL () operation (ECONOmical operation)

When ECONO COOL button is pressed in COOL mode, set temperature is automatically set 2°C higher.

Also the horizontal vane swings in various cycle according to the temperature of indoor heat exchanger(RT12).

SWING operation makes you feel cooler than set temperature. So, even though the set temperature is higher, the air conditioner can keep comfort. As a result, energy can be saved.

ECONO COOL operation is cancelled when ECONO COOL button is pressed once again or VANE CONTROL button is pressed or change to other operation mode.

<SWING operation>

In swing operation of ECONO COOL operation mode, the initial air flow direction is adjusted to "Horizontal".

According to the temperature of indoor coil thermistor RT12 at starting of this operation, next downward blow time is decided. Then when the downward blow has been finished, next horizontal blow time is decided.

For initial 10 minutes the swing operation is performed in table G~H for quick cooling.

Also, after 10 minutes when the difference of set temperature and room temperature is more than 2°C, the swing operation is performed in table D~H for more cooling.

The air conditioner repeats the swing operation in various cycle as follows.

	Temperature of indoor coil thermistor RT12	Downward blow time (second)	Horizontal blow time (second)
A	15°C or less	2	23
B	15°C to 17°C	5	20
C	17°C to 18°C	8	17
D	18°C to 20°C	11	14
E	20°C to 21°C	14	11
F	21°C to 22°C	17	8
G	22°C to 24°C	20	5
H	more than 24°C	23	2





11-8. TIMER OPERATION

1. How to set the timer





- (1) Press OPERATE/STOP (ON/OFF) button to start the air conditioner.
- (2) Check that the current time is set correctly.

NOTE : Timer operation will not work without setting the current time. Initially "AM0:00" blinks at the current time display of TIME MONITOR, so set the current time correctly with CLOCK SET button.

ON timer setting

- (1) Press ON-TIMER button() to set ON timer.
Each time the button is pressed, ON timer mode alternates between ON and OFF.
- (2) Set the time of the timer using TIME SET buttons ( and ).
Each time FORWARD button() is pressed, the set time increases by 10 minutes; each time BACKWARD button () is pressed, the set time decreases by 10 minutes.

OFF timer setting

- (1) Press OFF-TIMER button () to set OFF timer.
Each time the button is pressed, OFF timer mode alternates between ON and OFF.
- (2) Set the time of the timer using TIME SET buttons ( and ).
Each time FORWARD button () is pressed, the set time increases by 10 minutes; each time BACKWARD () button is pressed, the set time decreases by 10 minutes.

2. Cancel

TIMER setting can be cancelled with ON/OFF TIMER buttons.

To cancel ON timer, press ON-TIMER button ().

To cancel OFF timer, press OFF-TIMER button().

TIMER is cancelled and the display of set time disappears.

PROGRAM TIMER

- OFF timer and ON timer can be used in combination. The timer of the set time that is reached first will operate first.
- "↑" and "↓" display shows the order of OFF timer and ON timer operation.

(Example 1) The current time is 8:00 PM.

The unit turns off at 11:00 PM, and on at 6:00 AM.

(Example 2) The current time is 11:00 AM.

The unit turns on at 5:00 PM, and off at 9:00 PM.

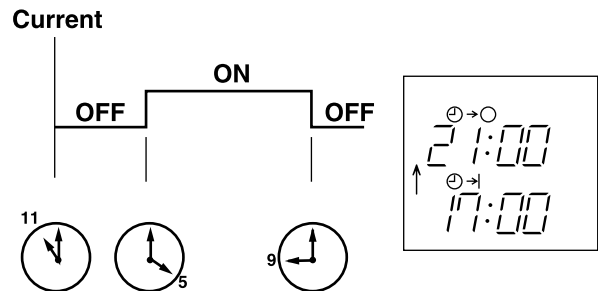
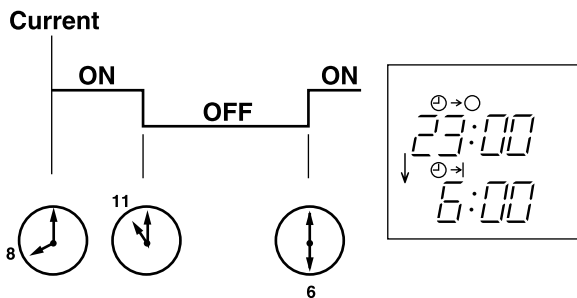

NOTE : If the main power is turned off or a power failure occurs while AUTO START/STOP timer is active, the timer setting is cancelled. As these models are equipped with an auto restart function, the air conditioner starts operating with timer cancelled when power is restored.

11-9. EMERGENCY/TEST OPERATION

In case of test run operation or emergency operation, use EMERGENCY OPERATION switch on the front of the indoor unit. Emergency operation is available when the remote controller is missing, has failed or the batteries of the remote controller run down. The unit will start and AREA lamp will light.

The first 30 minutes of operation is the test run operation. This operation is for servicing. The Indoor fan speed runs at High speed and the system is in continuous operation (The thermostat in ON).

After 30 minutes of test run operation, the system shifts to EMERGENCY COOL / HEAT MODE with a set temperature of 24°C. The fan speed shifts to Med.

The coil frost prevention works even in emergency operation, and defrosting too.

In the test run or emergency operation, the horizontal vane operates in VANE AUTO (@) mode.

Emergency operation continues until EMERGENCY OPERATION switch is pressed once or twice or the unit receives any signal from the remote controller. In case of latter, normal operation will start.

NOTE : Do not press EMERGENCY OPERATION switch during normal operation.

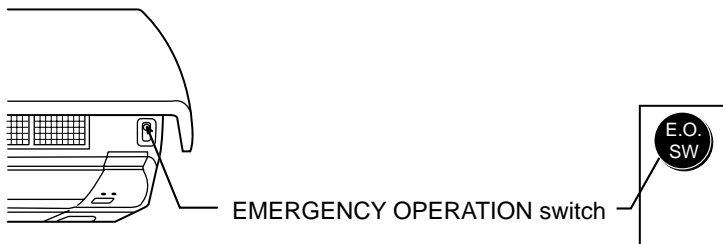

Operation mode	COOL	HEAT
Set temperature	24°C	24°C
Fan speed	Medium	Medium
Horizontal vane	Auto	Auto

The operation mode is indicated by the Operation Indicator lamp on the indoor unit as following

Operation indicator lamp

Press once <Cool>



Lighted



Not lighted

Press again <Heat>



Press once again <Stop>



11-10. INVERTER SYSTEM CONTROL

11-10-1. Inverter main power supply circuit

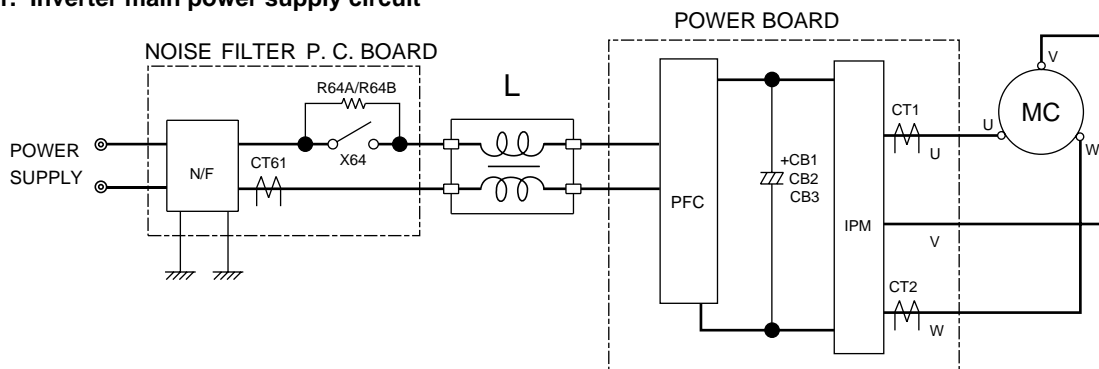

Function of main parts

SYMBOL	NAME	FUNCTION
IPM	INTELLIGENT POWER MODULE	It supplies three-phase AC power to compressor.
CB1~3	SMOOTHING CAPACITOR	It stabilizes the DC voltage.
CT1~2	CURRENT TRANSFORMER	It measures the current of the compressor motor.
CT61	CURRENT TRANSFORMER	It measures the current of the main power supply circuit.
L	REACTOR	It rectifies AC, controls its voltage and improves the power factor of power supply.
PFC	POWER FACTOR CONTROLLER	
R64A, R64B	CURRENT-LIMITING RESISTOR	It restricts rush current with the resistance.
X64	RELAY	It short-circuits the resistance which restricts rush current during the compressor operates.

11-10-2. Outline of main power supply circuit

1. At the start of operation

Main power supply circuit is formed when X64 (Relay) is turned ON at compressor startup.

To prevent rush current from running into the circuit when power supply is turned ON, R64A and R64B (Current-limiting resistor) are placed in sub circuit.

2. At normal operation

① When AC runs into noise filter P.C. board, its external noise is eliminated in the noise filter circuit.

② After noise being eliminated from AC, it is rectified to DC by L (Reactor) and PFC (Power factor controller). If the operating frequency becomes 25Hz or more, DC voltage rises to 370V.

③ DC voltage, to which has AC been rectified by process ②, is stabilized by CB1~3 (Smoothing capacitor) and supplied to IPM (Intelligent power module).

④ The DC (Bus voltage), which has been stabilized in process ③, is converted to three-phase AC by IPM and supplied to compressor.

⑤ CT1 and CT2 (Current Transformer), which are placed in the power supply circuit to compressor, are used to measure the value of phase current and locate the polar direction of rotor with algorithm. PWM (Pulse width modulation) controls impressed voltage and frequency with those information.

3. Power factor improvement

Booster coil L (Reactor) and PFC rectify AC to DC and control its voltage.

In the motor drive system of sine wave control, power factor can be improved by reducing harmonics PFC and L (Reactor) stabilize the voltage of DC supplied to inverter circuit and make its waveform smooth.

4. Power transistor module

IPM consists of the following components.

- Power Transistors (x6): Converts DC waveform to three-phase AC waveform and outputs it.
- Drive Circuit : Drives transistors.
- Protection circuit : Protects transistors from over current.

Since the above components are all integrated in IPM, IPM has a merit that can get the control circuit simplified and miniaturized.

5. Smoothing capacitor

CB1, CB2 and CB3 stabilize the DC voltage and supply it to IPM.

6. Elimination of electrical noise

Noise filter circuit, which is formed by *CMC COILS and capacitors placed on the noise filter P.C. board, eliminates electrical noise of AC power that is supplied to main power supply circuit. In short, common mode noise is absorbed in this circuit.

Moreover, normal mode noise is absorbed in another noise filter circuit which is formed by *NMC COILS and capacitors.

Both noise filter circuit exists for preventing the electrical noise generated in the inverter circuit from leaking out.

*CMC COILS; Common mode choke coils

*NMC COILS; Normal mode choke coils

11-10-3. Sine wave control

In these air conditioners, compressor equips brushless DC motor which doesn't have Hall element.

In short, the motor is sensorless. However, it's necessary to locate the polar direction of rotor in order to drive brushless DC motor efficiently. The general detection method of the polar direction for such a DC motor is to locate it from the voltage induced by unenergized stator.

Therefore, it is necessary to have a certain period of time in which the stator is being unenergized for the rotor position detection when the voltage of supplied power is impressed.

So the motor has been driven by square wave control (the conventional motor drive system) which energizes the motor only when the range of electrical angle is within 120° because it is forced to be unenergized within 30° at start & end of one heap in one waveform cycle (180°) when the voltage is impressed.

However, torque pulsation occurs at rotation in this method when the current-carrying phases are switched over to other phases in sequence. Therefore, sine wave control system is adopted for these air conditioners because it can make the phase-to-phase current waveform smoother (sine wave) in order to drive the motor more efficiently and smoothly.

11-10-4. Characteristics of sine wave control in case of brushless DC motor

- Although ordinary three-phase induction motor requires energy to excite the magnetic field of rotor, brushless DC motor doesn't need it. So, higher efficiency and torque are provided.
- This control provides the most efficient waveform corresponding to the rotation times of compressor motor.
- The rotation can be set to higher compared to the conventional motor drive system. So, the time in which air conditioner can be operated with energy saved is longer than conventional models. This can save annual electric consumption.
- Compared to square wave control, the torque pulsation is reduced at rotation so that the motor operates more quietly.
- Since response and efficiency are enhanced in sine wave control, finer adjustment can be provided.

	DC Motor	AC Motor
Rotor	Permanent magnet is embedded.	Excited by magnetic field of stator
Rotor Position Signal	Necessary	Unnecessary

※ In brushless DC motor, permanent magnet is embedded in the rotor. Therefore, it doesn't require energy to excite the rotor like AC motor does. However, it's necessary to control the frequency of three-phase AC current supplied to the stator according to the polar direction of magnet embedded in the rotor so as to drive the motor efficiently. Controlling three-phase AC current frequency also means controlling the timing to switch the polarity of stator. Therefore, the polar direction of rotor needs to be detected.

11-10-5. Control Method of Rotation Times

Sine wave control makes the current transformers conduct real time detection of the value of the current running into the motor, locates the rotor position from the detected value and decides if voltage should be impressed and if frequency should be changed.

Compared to the conventional control and rotor position detection method, sine wave control can provide finer adjustment of the voltage of supplied power. The value of the current running into the motor is determined by each motor characteristic.

11-11. OPERATIONAL FREQUENCY CONTROL OF OUTDOOR UNIT

1. Outline

The operational frequency is as following:

First, the target operational frequency is set based on the difference between the room temperature and the set temperature.

Second, the target operational frequency is regulated by discharge temperature protection, high pressure protection, electric current protection and overload protection and also by the maximum/minimum frequency.

2. Maximum/minimum frequency in each operation mode.

Applied model	COOL			HEAT			DRY	
	Minimum frequency	Rated frequency	Maximum frequency	Minimum frequency	Rated frequency	Maximum frequency	Minimum frequency	Maximum frequency
MUZ-GB50VA	20	78	98	30	75	108	20	98

※ The operation frequency in COOL mode is restricted the upper limit frequency after 1 hour as shown below for dew prevention.

It is rated frequency or less.

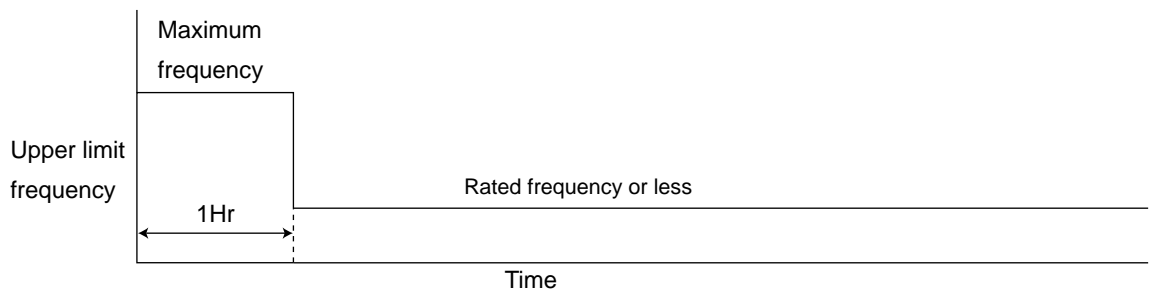

11-12. EXPANSION VALVE CONTROL (LEV CONTROL)

(1) Outline of LEV control

The LEV basic control is comprised of setting LEV opening degree to the standard opening degrees set for each operational frequency of the compressor. However, when any change in indoor/outdoor temperatures or other factors cause air conditioning load fluctuation, the LEV control also works to correct LEV opening degree based on discharge temperature (Shell temperature) of the compressor, developing the unit's performance.

standard specification	Control range	from minimum 59 pulse to maximum 500 pulse.
	Actuating speed	LEV opens 40 pulse/second and close 90 pulse/second
	Opening degree adjustment	LEV opening degree is always adjusted in opening direction. (When reducing the opening degree, LEV is once over-closed, and then adjusted to the proper degree by opening.
general operation	Unit OFF	LEV remains at maximum opening degree (reaches maximum opening degree approximate in 15 minutes after compressor stops)
	Remote controller ON	LEV is positioned. (first full-closed at zero pulse and then positioned.)
	COOL · DRY MODE During 1 to 5 minutes after compressor starts	LEV is fixed to standard opening degree according to operational frequency of compressor.
	HEAT MODE During 1 to 15 minutes after compressor starts	
	More than COOL, DRY: 5/ HEAT: 15 minutes have passed since compressor start-up	LEV opening degree is corrected to get target discharge temperature of compressor. (For discharge temperature lower than target temperature, LEV is corrected in closing direction.) (For discharge temperature higher than target temperature, LEV is corrected in opening direction.) ※It may take more than 30 minutes to reach target temperature, depending on operating conditions.
	Thermostat OFF	LEV is adjusted to exclusive opening degree for thermostat OFF.
	Thermostat ON	LEV is controlled in the same way as that after the compressor has started up.
Defrosting in HEAT mode	LEV is adjusted to open 500 pulse.	

(2) Time chart

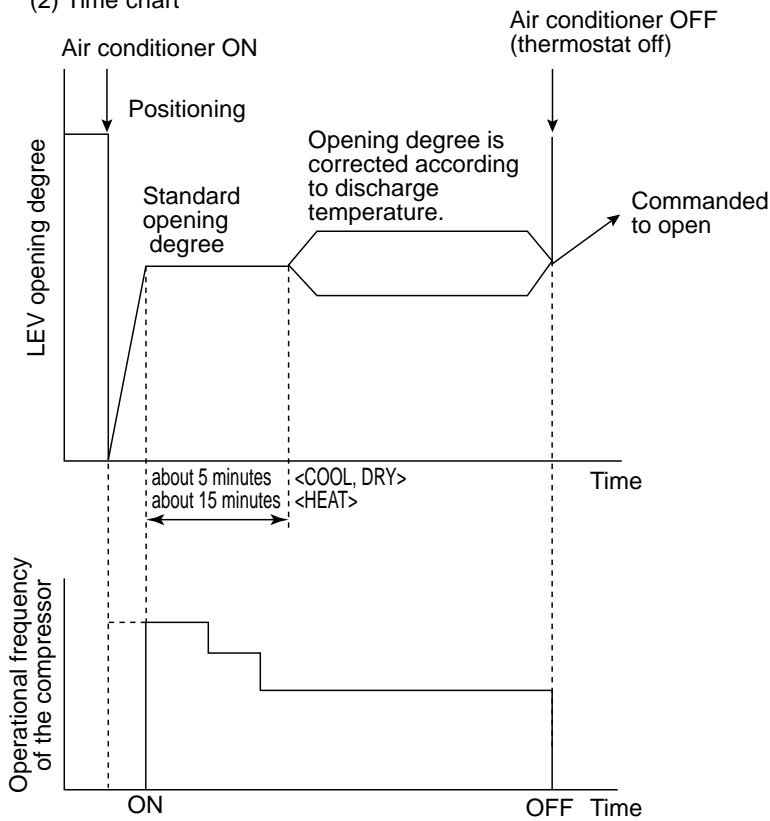

(3) Control data

(a) Reference value of target discharge temperature (COOL/HEAT °C)

Applied model	A	B	C	D	E	F
MUZ-GB50VA	60/60	60/65	60/70	63/75	66/80	67/80

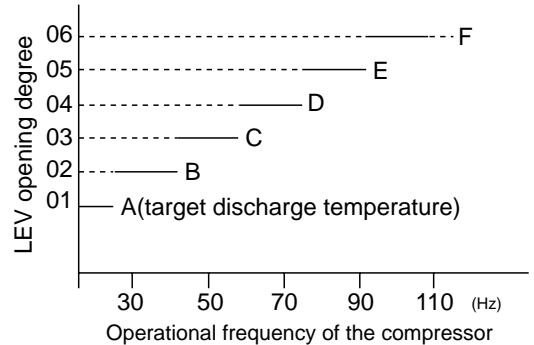

In COOL operation, the two indoor coil thermistors (one main and one sub) sense temperature ununiformity (super heat) at the heat exchanger, and when temperature difference have developed, the indoor coil thermistors adjust LEV opening degree to get approximate 10 degrees lower temperature than the target temperature in the table above, thus diminishing super heat.

(b) Reference value of LEV standard opening degree (COOL/ HEAT pulse)

Applied model	01	02	03	04	05	06
MUZ-GB50VA	150/130	166/150	186/170	206/196	230/210	260/226

**MXZ-2A30VA MXZ-2A52VA MXZ-4A71VA MXZ-5A100
MXZ-2A40VA MXZ-3A54VA MXZ-4A80VA**

12-1. INVERTER SYSTEM CONTROL

12-1-1. Inverter main power supply circuit

MXZ-2A30/40/52VA

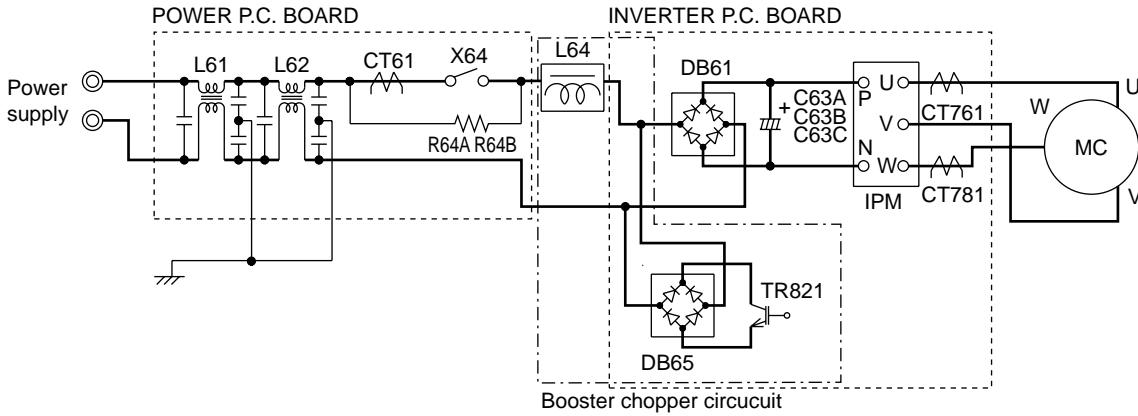

Function of main parts

SYMBOL	NAME	FUNCTION
IPM	INTELLIGENT POWER MODULE	It supplies three-phase AC power to compressor.
C63A/C63B/C63C	SMOOTHING CAPACITOR	It stabilizes the DC voltage.
CT761/CT781	CURRENT TRANSFORMER	It measures the current of the compressor motor.
CT61	CURRENT TRANSFORMER	It measures the value of current which is supplied to the main power supply circuit.
DB61	DIODE MODULE	It converts the AC voltage to DC voltage.
R64A, R64B	CURRENT-LIMITING RESISTOR	It absorbs the rush current not to run into the main power supply circuit when the electricity turns ON.
X64	RELAY	It short-circuits the resistance which restricts rush current during the normal operation after the compressor startup.
DB65	DIODE MODULE	Booster chopper circuit It improves power factor.
TR821	SWITCHING POWER TRANSISTOR	
L64	REACTOR	

**MXZ-3A54VA
MXZ-4A71/80VA
MXZ-5A100VA**

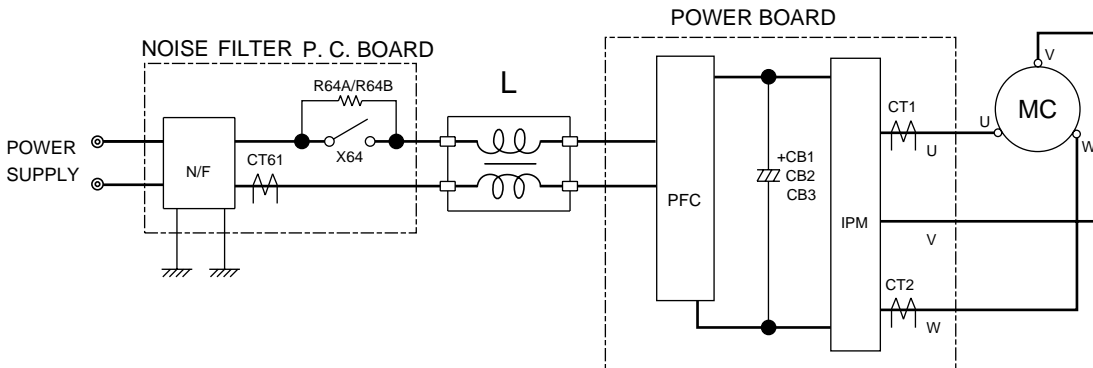

Function of main parts

SYMBOL	NAME	FUNCTION
IPM	INTELLIGENT POWER MODULE	It supplies three-phase AC power to compressor.
CB1~3	SMOOTHING CAPACITOR	It stabilizes the DC voltage.
CT1~2	CURRENT TRANSFORMER	It measures the current of the compressor motor.
CT61	CURRENT TRANSFORMER	It measures the current of the main power supply circuit.
L	REACTOR	It rectifies AC, controls its voltage and improves the power factor of power supply.
PFC	POWER FACTOR CONTROLLER	
R64A, R64B	CURRENT-LIMITING RESISTOR	It restricts rush current with the resistance.
X64	RELAY	It short-circuits the resistance which restricts rush current during the compressor operates.

12-1-2. Outline of main power supply circuit

MXZ-2A30/40/52VA

1. At the start of operation

Main power supply circuit is formed when X64 (Relay) is turned ON at compressor startup.

To prevent rush current from running into the circuit when power supply is turned ON, R64A and R64B (Current-limiting resistor) are placed in sub circuit.

2. At normal operation

- ① When AC runs into POWER P.C. board, its external noise is eliminated in the noise filter circuit.
- ② After noise is eliminated from AC, it is rectified to DC by DB61 (Diode module).
- ③ DC voltage, to which AC has been rectified by process ②, is stabilized by C63A, C63B and C63C (Smoothing capacitor) and supplied to IPM (Intelligent power module).
- ④ DC voltage, which has been stabilized in process ③, is converted to three-phase AC by IPM and supplied to compressor.
- ⑤ CT761 and CT781 (Current Transformer), which are placed in the power supply circuit to compressor, are used to measure the value of phase current and locate the polar direction of rotor with algorithm. PWM (Pulse width modulation) controls impressed voltage and frequency with those information.

3. Purpose of PAM adoption

PAM : Pulse Amplitude Modulation

PAM has been adopted for the efficiency improvement and the adaptation to IEC harmonic current emission standard.

Outline of simple partial switching method

In conventional inverter models, diode module rectifies AC voltage to DC voltage, smoothing capacitor makes its DC waveform smooth, and IPM converts its DC voltage to imitated AC voltage again in order to drive the compressor motor.

However, it has been difficult to meet IEC harmonic current emission standard by above circuit because harmonic gets generated in the input current waveform and power factor gets down. The simple partial switching method with PAM, which has been adopted this time, places and utilizes the booster chopper circuit (L64, DB65 and TR821) before rectifying AC voltage in the general passive-method converter circuit. As harmonic gets suppressed and the peak of waveform gets lower by adding booster chopper circuit as mentioned above and by synchronizing the timing of switching with the zero-cross point of waveform, the input current waveform can be improved and the requirement of IEC harmonic current emission standard can be satisfied. Since the switching is synchronized with the zero cross point, this simple partial switching method has the feature of lower energy loss compared to active filter method. In addition, output and efficiency is enhanced by combining with vector-controlled inverter in order to boost the voltage of power supplied to IPM.

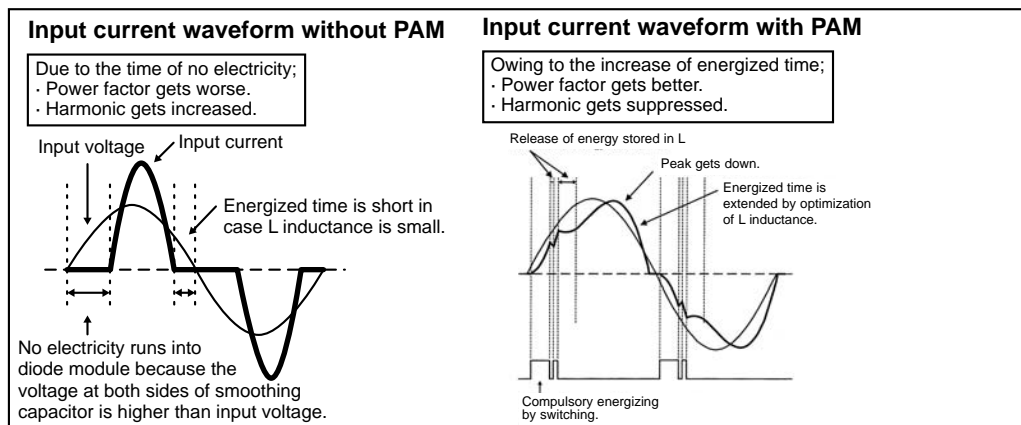

4. Intelligent power module

IPM consists of the following components

- IGBT (x6) : Converts DC waveform to three-phase AC waveform and outputs it.
- Drive Circuit : Drives transistors.
- Protection circuit : Protects transistors from overcurrent.

Since the above components are all integrated in IPM, IPM has a merit to make the control circuit simplify and miniaturize.

5. Smoothing capacitor

C63A, C63B and C63C stabilize the DC voltage and supply it to IPM.

6. Elimination of electrical noise

Noise filter circuit, which is formed by *CMC COILS capacitors placed on the POWER P.C. board, eliminates electrical noise of AC power that is supplied to main power supply circuit. And this circuit prevents the electrical noise generated in the inverter circuit from leaking out.

*CMC COILS; Common mode choke coils

MXZ-3A54VA

MXZ-4A71/80VA/5A100

1. At the start of operation

Main power supply circuit is formed when X64 (Relay) is turned ON at compressor startup.

To prevent rush current from running into the circuit when power supply is turned ON, R64A and R64B (Current-limiting resistor) are placed in sub circuit.

2. At normal operation

① When AC runs into noise filter P.C. board, its external noise is eliminated in the noise filter circuit.

② After noise being eliminated from AC, it is rectified to DC by L (Reactor) and PFC (Power factor controller). If the operating frequency becomes 25Hz or more, DC voltage rises to 370V.

③ DC voltage, to which has AC been rectified by process ②, is stabilized by CB1~3 (Smoothing capacitor) and supplied to IPM (Intelligent power module).

④ The DC (Bus voltage), which has been stabilized in process ③, is converted to three-phase AC by IPM and supplied to compressor.

⑤ CT1 and CT2 (Current Transformer), which are placed in the power supply circuit to compressor, are used to measure the value of phase current and locate the polar direction of rotor with algorithm. PWM (Pulse width modulation) controls impressed voltage and frequency with those information.

3. Power factor improvement

Booster coil L (Reactor) and PFC rectify AC to DC and control its voltage.

In the motor drive system of sine wave control, power factor can be improved by reducing harmonics PFC and L (Reactor) stabilize the voltage of DC supplied to inverter circuit and make its waveform smooth.

4. Power transistor module

IPM consists of the following components.

- Power Transistors (x6): Converts DC waveform to three-phase AC waveform and outputs it.
- Drive Circuit : Drives transistors.
- Protection circuit : Protects transistors from over current.

Since the above components are all integrated in IPM, IPM has a merit that can get the control circuit simplified and miniaturized.

5. Smoothing capacitor

CB1, CB2 and CB3 stabilize the DC voltage and supply it to IPM.

6. Elimination of electrical noise

Noise filter circuit, which is formed by *CMC COILS and capacitors placed on the noise filter P.C. board, eliminates electrical noise of AC power that is supplied to main power supply circuit. In short, common mode noise is absorbed in this circuit.

Moreover, normal mode noise is absorbed in another noise filter circuit which is formed by *NMC COILS and capacitors.

Both noise filter circuit exists for preventing the electrical noise generated in the inverter circuit from leaking out.

*CMC COILS; Common mode choke coils

*NMC COILS; Normal mode choke coils

12-1-3. Sine wave control

In these air conditioners, compressor equips brushless DC motor which doesn't have Hall element.

In short, the motor is sensorless. However, it's necessary to locate the polar direction of rotor in order to drive brushless DC motor efficiently. The general detection method of the polar direction for such a DC motor is to locate it from the voltage induced by unenergized stator.

Therefore, it is necessary to have a certain period of time in which the stator is being unenergized for the rotor position detection when the voltage of supplied power is impressed.

So the motor has been driven by square wave control (the conventional motor drive system) which energizes the motor only when the range of electrical angle is within 120° because it is forced to be unenergized within 30° at start & end of one heap in one waveform cycle (180°) when the voltage is impressed.

However, torque pulsation occurs at rotation in this method when the current-carrying phases are switched over to other phases in sequence. Therefore, sine wave control system is adopted for these air conditioners because it can make the phase-to-phase current waveform smoother (sine wave) in order to drive the motor more efficiently and smoothly.

12-1-4. Characteristics of sine wave control in case of brushless DC motor

- Although ordinary three-phase induction motor requires energy to excite the magnetic field of rotor, brushless DC motor doesn't need it. So, higher efficiency and torque are provided.
- This control provides the most efficient waveform corresponding to the rotation times of compressor motor.
- The rotation can be set to higher compared to the conventional motor drive system. So, the time in which air conditioner can be operated with energy saved is longer than conventional models. This can save annual electric consumption.
- Compared to square wave control, the torque pulsation is reduced at rotation so that the motor operates more quietly.
- Since response and efficiency are enhanced in sine wave control, finer adjustment can be provided.

	DC Motor	AC Motor
Rotor	Permanent magnet is embedded.	Excited by magnetic field of stator
Rotor Position Signal	Necessary	Unnecessary

※ In brushless DC motor, permanent magnet is embedded in the rotor. Therefore, it doesn't require energy to excite the rotor like AC motor does. However, it's necessary to control the frequency of three-phase AC current supplied to the stator according to the polar direction of magnet embedded in the rotor so as to drive the motor efficiently. Controlling three-phase AC current frequency also means controlling the timing to switch the polarity of stator. Therefore, the polar direction of rotor needs to be detected.

12-1-5. Control Method of Rotation Times

Sine wave control makes the current transformers conduct real time detection of the value of the current running into the motor, locates the rotor position from the detected value and decides if voltage should be impressed and if frequency should be changed.

Compared to the conventional control and rotor position detection method, sine wave control can provide finer adjustment of the voltage of supplied power. The value of the current running into the motor is determined by each motor characteristic.

12-2. EXPANSION VALVE CONTROL (LEV CONTROL)

Linear expansion valve (LEV) is controlled by "Thermostat ON" commands given from each unit.

Indoor unit status	LEV opening
Stop of all indoor unit	Opening before stop → 500 pulse in 15 minutes
When outdoor unit is operating, some indoor units stop and some operate.	COOL : 5 pulse (fully closed) HEAT (MXZ-2A) : 59 pulse (slightly opened) (MXZ-3A/4A71/4A80VA- [E1]) :140 pulse (slightly opened) (MXZ-4A80VA- [E2]/5A) :100 → 59pulse
Thermostat OFF in COOL or DRY mode	When the outdoor unit operates (When the other indoor unit operates): 5 pulse. When outdoor unit stops. (When the other indoor unit stops or thermo off): Maintain LEV opening before stop → 500 pulse in 15 minutes
Thermostat ON in COOL or DRY mode	<ul style="list-style-type: none"> LEV opening for each indoor unit is determined by adding adjustment in accordance with the number of operating unit and the capacity class to standard opening, based on the operation frequency: Ex.) Opening 130 pulse in standard opening 1 → Minimum 80 pulse, Maximum 205 pulse. (Capacity code 4 at 1 unit operation) (Capacity code 1 at 4 units operation) After starting operation, adjustment in accordance with intake superheat, discharge temperature is included in standard opening. ※1 <p>Note: LEV opening in each frequency at DRY operation and COOL operation is the same. However, velocity and compressor operation frequency controls are different. (Refer to 12-3. OPERATIONAL FREQUENCY RANGE) (As far as the indoor unit velocity control goes, refer to DRY operation in MICROPROCESSOR CONTROL in indoor unit.)</p>
Thermostat OFF in HEAT mode	<ul style="list-style-type: none"> When the outdoor unit operates. (When the other indoor unit operates): 59 pulse (MXZ-2A), 140pulse (MXZ-3A/4A/5A). When the outdoor unit stops. (When the other indoor unit stops or thermo off): Maintain LEV opening before stop → 500 pulse in 15 minutes.
Thermostat ON in HEAT mode	<ul style="list-style-type: none"> LEV opening for each indoor unit is determined by adding adjustment in accordance with the number of operating unit and the capacity class to standard opening, based on the operation frequency: Ex.) Opening 120 pulse in standard opening 1 → Minimum 70 pulse, Maximum 165 pulse. (Capacity code 4 at 1 unit operation) (Capacity code 1 at 4 units operation) After starting operation, opening becomes the one that adjustment in accordance with discharge temperature was added to basic opening. ※1

※1 LEV opening when the outdoor unit is operating: Upper limit 500 pulse, Lower limit 59 pulse(MXZ-2A/4A80VA- [E2]/5A), 53pulse (MXZ-3A/4A71/4A80VA- [E1]).

MXZ-3A/4A71/4A80VA-E1

The table below shows the role of Exclusive LEV and Receiver LEV in each operation mode.

		Circulation Amount Control	Capacity Distribution	Discharge Temperature Protection	High Pressure Protection	*Evaporation Temperature Protection
COOL	Exclusive LEV	○	○	○	○	○
	Receiver LEV	×	×	○	○	○
HEAT	Exclusive LEV	×	○	○	○	—
	Receiver LEV	○	×	○	○	—

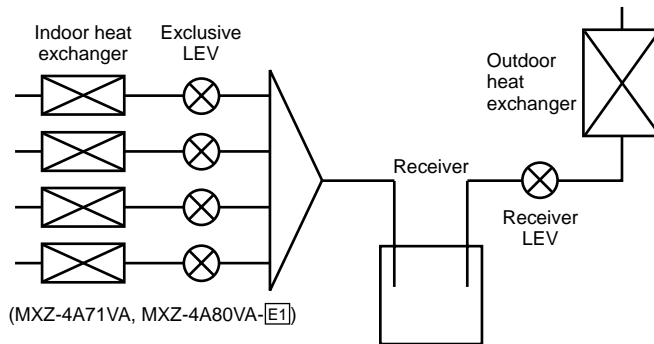

※In COOL mode, the two indoor coil thermistor (one main and one sub) sense temperature ununiformity (superheat) at the heat exchanger, and when temperature difference have developed, the indoor coil thermistors adjust LEV opening to diminish the superheat. This action is called Evaporation Temperature Protection.

The opening pulse of the Receiver LEV is fixed to the standard No.3 in cooling operation, and so is that of each Exclusive LEV in heating operation.

However the opening pulse will be changed to the standard No.4 or No.5 when the discharge temperature protection or high-pressure protection is working.

In addition to that, it will also be changed to standard No.2 or No.1 when the opening pulse of the each Exclusive LEV becomes 100 pulse or less in cooling operation or so does that of Receiver LEV in heating operation.

<MXZ-3A54VA MXZ-4A71VA>

Standard No.	Number of operating indoor units	LEV opening (pulse)							
		COOL				HEAT			
		1 unit	2 units	3 units	4 units (MXZ-4A71VA)	1 unit	2 units	3 units	4 units (MXZ-4A71VA)
1		200	150	250	250	120	120	120	120
2		300	320	320	320	140	140	140	140
3		400	360	370	380	160	160	160	160
4		450	410	420	430	220	220	220	220
5		500	500	500	500	280	280	280	280

<MXZ-4A80VA-E1>

Standard No.	Number of operating indoor units	LEV opening (pulse)							
		COOL				HEAT			
		1 unit	2 units	3 units	4 units	1 unit	2 units	3 units	4 units
1		150	250	250	250	250	250	250	240
2		250	320	320	320	300	300	300	290
3		350	360	370	380	450	380	380	380
4		400	410	420	430	460	400	390	390
5		450	460	470	480	470	450	440	430

Determination of LEV standard opening in each indoor unit

- The standard opening is on the straight line, which connects an each standard point in the section where divided into seven according to the operation frequency of compressor as shown in the figure below. (LEV opening is controlled in proportion to the operation frequency.)

Note: Opening is adjusted at the standard opening according to the indoor unit conditions.

However, inclination of standard opening in each point of opening does not change with the original curve.

- Add opening provided in Difference in Capacity in the table below to the standard opening from 1 to 8, when capacity of the indoor unit is excluding code 1.
- Add opening provided in Difference in Operation number in the table below to determined LEV opening for each indoor unit, when 2, 3, 4 or 5 indoor units are operated at the same time.

Note: Even when the adjusted standard opening exceeds the driving range from 59 to 500 pulse, actual driving output opening is in a range from 59 to 500 pulse.

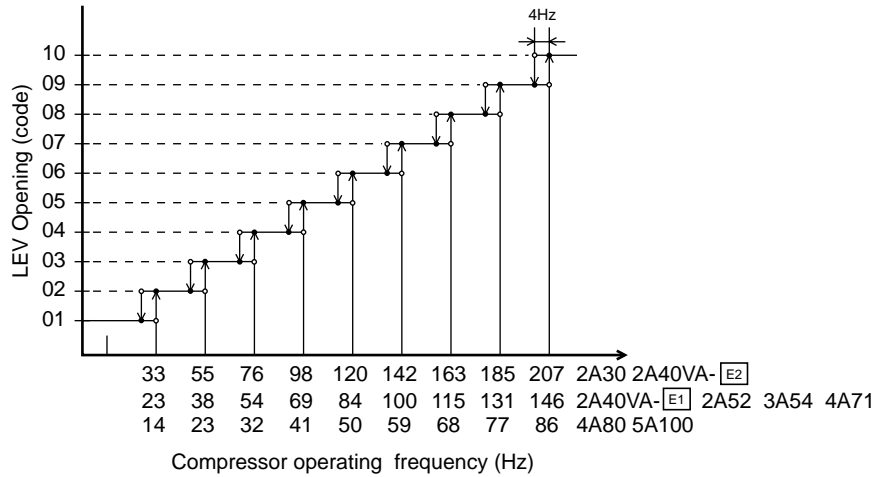

MXZ-2A30VA MXZ-2A40VA MXZ-2A52VA

LEV Opening(code)	Standard opening (pulse)									
	01	02	03	04	05	06	07	08	09	10
COOL	240	260	280	300	330	350	370	390	400	410
HEAT	200	220	250	280	300	320	340	360	380	400

	Difference in capacity			Difference in operation number
	Code3,4	Code5,6	Code7,8	
COOL	10	20	30	-60
HEAT	5	10	15	-100

MXZ-3A54VA MXZ-4A71VA

LEV Opening(code)	Standard opening (pulse)									
	01	02	03	04	05	06	07	08	09	10
COOL	120	130	136	146	156	160	170	180	190	200
HEAT	80	84	90	110	120	130	140	150	160	170

	Difference in capacity							Difference in operation number		
	Code3,4	Code5,6	Code7,8	Code9,10	Code11,12	Code13,14	Code15or above	2	3	4
COOL	3	6	9	12	15	25	35	-20	-30	-40
HEAT	3	6	9	52	55	65	75	0	0	0

MXZ-4A80VA-E1

LEV Opening(code)	Standard opening (pulse)									
	01	02	03	04	05	06	07	08	09	10
COOL	126	130	134	138	140	142	182	228	296	310
HEAT	140	146	150	170	180	200	224	244	272	280

	Difference in capacity							Difference in operation number		
	Code3,4	Code5,6	Code7,8	Code9,10	Code11,12	Code13,14	Code15or above	2	3	4
COOL	3	6	9	12	15	25	35	-20	-30	-40
HEAT	3	6	9	52	55	65	75	0	0	0

MXZ-4A80VA-^[E2] MXZ-5A100VA

Exclusive LEV

LEV Opening(code)	Standard opening (pulse)									
	01	02	03	04	05	06	07	08	09	10
COOL	126	130	134	138	150	160	170	180	190	200
HEAT	248	248	258	266	274	280	286	292	300	306

	Difference in capacity							Difference in operation number			
	Code3,4	Code5,6	Code7,8	Code9,10	Code11,12	Code13,14	Code15or above	2	3	4	5
COOL	3	6	9	12	15	25	35	-20	-30	-30	-30
HEAT	3	6	9	52	55	65	75	-4	-8	-12	-16

Receiver LEV

LEV Opening(code)	Standard opening (pulse)									
	01	02	03	04	05	06	07	08	09	10
COOL	270	280	290	300	310	320	330	340	350	360
HEAT	140	152	160	170	180	200	224	244	274	280

operation number	Difference in operation number			
	2	3	4	5
COOL	28	56	84	112
HEAT	-45	-60	-60	-60

Capacity code

Capacity code	3	4	7	10	12	13
Indoor unit capacity(kw)	2.2	2.5	3.5	5.0	6.0	7.1

<Correction>

	COOL	DRY	HEAT
① Discharge temperature	●*2	●*2	●
② Each correction <ul style="list-style-type: none"> (Each gas pipe temperature thermistor - Minimum gas pipe temperature thermistor)*1 (Main indoor coil thermistor - Sub indoor coil thermistor) 	●	●	—

*1 Perform this, when number of operation units is 2 units or more.

MXZ-2A, MXZ-4A80VA -^[E2] and MXZ-5A are excluded.

*2 Correct the LEV opening by discharge temperature.

(1) LEV opening correction by discharge temperature

The target discharge temperature is determined according to frequency zone and number of operation unit of the compressor.

MXZ-2A30VA MXZ-2A40VA -^[E2]

Operation frequency of compressor (Hz)	Target discharge temperature (°C)			
	COOL		HEAT	
	1 unit	2 units	1 unit	2 units
Minimum ~ 33	56	60	55	51
34 ~ 55	59	61	60	58
56 ~ 76	59	64	65	64
77 ~ 98	60	67	70	71

MXZ-2A40VA -^[E1] MXZ-2A52VA

Operation frequency of compressor (Hz)	Target discharge temperature (°C)			
	COOL		HEAT	
	1 unit	2 units	1 unit	2 units
Minimum ~ 23	56	60	57	51
24 ~ 38	59	61	63	58
39 ~ 54	59	64	69	64
55 ~ 69	60	67	75	71
70 ~ 85	61	67	80	77
86 ~ 100	62	69	86	83
101 ~ Maximum	63	70	90	90

MXZ-3A54VA MXZ-4A71VA

Operation frequency of compressor (Hz)	Target discharge temperature (°C)							
	COOL				HEAT			
	1 unit	2 units	3 units	4 units (MXZ-4A71VA)	1 unit	2 units	3 units	4 units (MXZ-4A71VA)
Minimum ~ 23	35	58	62	62	50	50	50	50
24 ~ 38	40	60	65	65	56	50	55	55
39 ~ 54	49	65	70	70	60	56	60	60
55 ~ 69	58	68	70	70	63	60	60	60
70 ~ 85	65	70	72	72	66	60	60	60
86 ~ 100	70	70	72	72	67	60	60	60
101 ~ Maximum	70	70	72	72	70	60	60	60

MXZ-4A80VA -[E1]

Operation frequency of compressor (Hz)	Target discharge temperature (°C)							
	COOL				HEAT			
	1 unit	2 units	3 units	4 units	1 unit	2 units	3 units	4 units
Minimum ~ 14	35	55	57	59	52	62	50	50
15 ~ 23	40	55	57	60	58	66	55	55
24 ~ 32	49	58	63	65	65	74	60	60
33 ~ 41	58	60	65	67	68	78	67	67
42 ~ 50	65	65	70	72	68	78	72	72
51 ~ 59	68	68	73	74	68	78	76	76
60 ~ 68	70	70	75	75	68	78	76	76
69 ~ 77	75	73	80	80	68	78	76	76
78 ~ 86	75	75	82	84	68	78	76	76
87 ~ Maximum	75	80	82	84	78	78	76	76

MXZ-4A80VA -[E2] MXZ-5A100VA

Operation frequency of compressor (Hz)	Target discharge temperature (°C)							
	COOL				HEAT			
	1 unit	2 units	3 units	4,5 units ※	1 unit	2 units	3 units	4,5 units ※
Minimum ~ 14	35	55	57	60	52	62	50	50
15 ~ 23	42	55	57	60	58	66	55	50
24 ~ 32	49	58	63	60	65	74	60	50
33 ~ 41	58	60	65	62	68	78	67	50
42 ~ 50	65	65	70	65	68	78	72	55
51 ~ 59	68	68	73	70	68	78	76	60
60 ~ 68	70	70	75	70	68	78	76	60
69 ~ 77	75	73	80	72	68	78	76	60
78 ~ 86	75	75	82	72	68	78	76	60
87 ~ Maximum	75	80	82	72	78	78	76	60

※ "5 units" is MXZ-5A.

Correct the LEV opening according to the difference between target discharge temperature and discharge temperature.

MXZ-2A30VA MXZ-2A40VA MXZ-2A52VA MXZ-3A54VA MXZ-4A71VA

Discharge temperature (°C)	LEV opening correction (pulse)	
	COOL	HEAT
More than Target discharge temperature+10	5	8
Target discharge temperature+10 to Target discharge temperature+5	4	3
Target discharge temperature+5 to Target discharge temperature+2	2	1
Target discharge temperature+2 to Target discharge temperature-2	0	0
Target discharge temperature-2 to Target discharge temperature-5	-1	-1
Target discharge temperature-5 to Target discharge temperature-10	-3	-2
Target discharge temperature-10 or less	-4	-3

MXZ-4A80VA MXZ-5A100VA

Discharge temperature (°C)	LEV opening correction (pulse)	
	COOL	HEAT
More than Target discharge temperature+12	4	6
Target discharge temperature+12 to Target discharge temperature+5	2	2
Target discharge temperature+5 to Target discharge temperature+3	1	1
Target discharge temperature+3 to Target discharge temperature-3	0	0
Target discharge temperature-3 to Target discharge temperature-5	-1	-1
Target discharge temperature-5 to Target discharge temperature-12	-3	-2
Target discharge temperature-12 or less	-8	-8

(2) Separate correction (COOL,DRY)

(Correction by the separate superheat)

a) Correct the LEV separately by temperature difference between each gas pipe temperature and the minimum gas pipe temperature of all.

① Calculate each superheat of the unit from the expression below;

$$\text{(Superheat)} = \text{(Each gas pipe temperature)} - \text{(Minimum gas pipe temperature)}$$

② Separate correction is performed according to each superheat in the table below.

MXZ-3A54VA MXZ-4A71VA

Superheat	LEV opening correction (pulse)
more than 9	3
6 to 9	2
3 to 6	1
3 or less	0

MXZ-4A80VA-^[E1]

Superheat	LEV opening correction (pulse)
more than 9	12
6 to 9	8
3 to 6	4
3 or less	0

b) Correct the LEV separately by temperature difference “ ΔRT ” between main/sub indoor coil thermistor.

ΔRT	LEV opening correction (pulse)
$6 \leq \Delta RT$	2
$4 \leq \Delta RT < 6$	1
$\Delta RT < 4$	0

In addition, decrease the target discharge temperature corresponding ΔRT .

ΔRT	Temperature to be decreased (°C)
$6 \leq \Delta RT$	-10
$4 \leq \Delta RT < 6$	-5
$\Delta RT < 4$	-5

12-3. OPERATIONAL FREQUENCY RANGE

MXZ-2A30VA

Number of operating unit	Capacity code	COOL (Hz)		DRY (Hz)	HEAT (Hz)		
		Min.	Max.		Min.	Max.	Defrost
1	3, 4	35	58	35	35	77	77
2	~ 8	35	77	68	35	77	77

MXZ-2A40VA -[E2]

Number of operating unit	Capacity code	COOL (Hz)		DRY (Hz)	HEAT (Hz)		
		Min.	Max.		Min.	Max.	Defrost
1	3, 4	35	58	35	35	98	98
	7	35	68	45	35	98	98
2	~ 11	35	98	68	35	98	98

MXZ-2A40VA -[E1]

Number of operating unit	Capacity code	COOL (Hz)		DRY (Hz)	HEAT (Hz)		
		Min.	Max.		Min.	Max.	Defrost
1	3, 4	12	48	25	20	70	70
	7	12	48	30	20	70	70
2	~ 11	16	70	52	40	70	70

MXZ-2A52VA

Number of operating unit	Capacity code	COOL (Hz)		DRY (Hz)	HEAT (Hz)		
		Min.	Max.		Min.	Max.	Defrost
1	3, 4	12	48	25	20	72	72
	7	12	48	30	20	90	90
2	~ 11	16	105	52	40	105	100
	14	16	105	52	40	105	100

MXZ-3A54VA MXZ-4A71VA

Number of operating unit	Capacity code	COOL (Hz)		DRY (Hz)	HEAT (Hz)		
		Min.	Max.		Min.	Max.	Defrost
1	3, 4	20	65	25	48	92	92
	7	20	85	30	48	92	92
	10	20	100	75	48	100	100
	12	20	100	75	48	100	100
	13	20	100	75	48	100	100
2	~ 7	30	105	52	58	112	100
	8 ~ 10	30	105	52	58	112	100
	11 ~ 13	30	105	52	58	112	100
	14 ~ 16	30	105	52	58	112	100
	17 ~	20	105	100	58	112	100
3	9 ~	40	105	105	66	112	100
4 *	12 ~	52	105	105	88	112	100

* MXZ-4A71VA only

MXZ-4A80VA -[E1]

Number of operating unit	Capacity code	COOL (Hz)		DRY (Hz)	HEAT (Hz)		
		Min.	Max.		Min.	Max.	Defrost
1	3, 4	15	58	20	22	48	48
	7	15	58	25	22	48	48
	10	15	62	44	22	62	58
	12	15	68	44	22	90	58
	13	15	79	44	22	90	58
2	~ 7	24	80	31	35	70	58
	8 ~ 10	24	80	31	35	70	58
	11 ~ 13	24	80	31	35	90	58
	14 ~ 16	24	80	31	35	94	58
	17 ~	24	80	59	35	94	58
3	9 ~	52	90	65	39	94	58
4	12 ~	63	94	65	52	94	58

MXZ-4A80VA -[E2] MXZ-5A100VA

Number of operating unit	Capacity code	COOL (Hz)		DRY (Hz)	HEAT (Hz)			
		Min.	Max.		Min.	Max.		Defrost
						4A	5A	
1	3, 4	15	58	20	22	70		58
	7	15	58	25	22	70		58
	10	18	62	44	22	80		58
	12	18	68	44	22	90		58
	13	18	79	44	22	90		58
2	~ 7	24	80	31	35	80		58
	8	24	80	31	35	80		58
	9, 10	42	80	31	35	80		58
	11 ~ 13	42	80	31	35	94		58
	14 ~ 16	42	90	31	35	94		58
	17 ~	42	90	59	35	94		58
3	9 ~	58	90	65	39	94	105	58
4								
5*	12 ~	63	94	65	52	94	120	58

* MXZ-5A only

12-4. HEAT DEFROSTING CONTROL
(1) Starting conditions of defrosting

When the following conditions a) ~ c) are satisfied, the defrosting starts.

- The defrost thermistor reads -3°C or less.
- The cumulative operation time of the compressor has reached any of the set values* (31, 35, 45, 55, 65, 75, 85, 95, 105, 115, 150 minutes).
- More than 5 minutes have passed since the start-up of the compressor.

* Set value of compressor operation time(hereinafter referred to as defrost interval)

This is decided by the temperature of defrost thermistor and ambient temperature thermistor, the previous defrosting time. For example, the first defrost interval is 40 minutes long, and the second is 45 minutes long. The third and subsequent intervals are set to be longer, and less frequent, depending on defrosting time.

The third and subsequent defrost intervals follow any of the three patterns ...5 or 10 to 20 minutes longer, the same, or 5 or 10 to 20 minutes shorter compared with the previous defrost interval ... with the longest 125 minutes and the shortest 40 minutes.

(2) Releasing conditions of defrosting

Defrosting is released when any of the following conditions is satisfied:

- The defrost thermistor continues to read 13.2°C (2A/3A/4A71/4A80VA-[E1])/ 10.4°C (4A80VA-[E2]/5A).
- Defrosting time exceeds 10 minutes.
- Any other mode than HEAT mode is set during defrosting.

12-5. DISCHARGE TEMPERATURE PROTECTION CONTROL

This protection controls the compressor ON/OFF and operation frequency according to temperature of the discharge temperature thermistor.

(1) Compressor ON/OFF

When temperature of the discharge temperature thermistor exceeds 116°C, the control stops the compressor.

When temperature of the discharge temperature thermistor is 80°C (2A/3A/4A71/4A80VA-^[E1]) / 100°C (4A80VA-^[E2]/5A) or less, the controls starts the compressor.

(2) Compressor operation frequency

When temperature of the discharge temperature thermistor is expected to be higher than 116°C, the control decreases 12Hz from the current frequency.

When temperature of the discharge temperature thermistor is expected to be higher than 111°C and less than 116°C, the control decreases 6Hz from the current frequency.

When temperature of the discharge temperature thermistor is expected to be higher than 104°C and less than 111°C, the control is set at the current frequency.

12-6. REFRIGERANT RECOVERY CONTROL ON HEATING

MXZ-2A30VA MXZ-2A40VA MXZ-2A52VA

<Control status>

The control performs when the all the following status are satisfied;

- When one or more indoor units are operating in HEAT mode. (Excluding thermostat OFF)
- When discharge temperature becomes 107°C or more.
- When it passed 60 minutes or more since the operation has started or the last refrigerant recovery has controlled.

<Control details>

LEV opening of indoor unit not operating is controlled to be 80 pulse.

<Control finish status>

The control finishes either as follows. However, the LEV opening is considered to be 59 pulse.

- When it passed 60 seconds since the control has started.
- When the discharge temperature is 90°C or less.

12-7. OUTDOOR FAN CONTROL

Fan speed is switched according to the number of operating indoor unit and the compressor frequency.

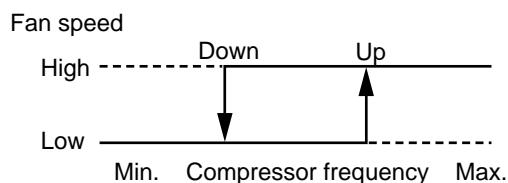

<Relation between compressor frequency and fan speed>

Mode	Fan speed	Compressor frequency (Hz)		
		MXZ-2A30VA MXZ-2A40VA- ^[E2]	MXZ-2A40VA- ^[E1] MXZ-2A52VA MXZ-3A54VA MXZ-4A71/80VA- ^[E1]	MXZ-4A80VA- ^[E2] MXZ-5A100VA
COOL	Up	56	40	50
	Down	42	30	40
HEAT	Up	56	40	50
	Down	42	30	40

Note

- When the indoor coil thermistor is 57°C or more on HEAT operation, fan speed is fixed to Low speed.
Or, the indoor coil thermistor is 45°C or less on HEAT operation, fan speed is back to normal.

12-8. PRE-HEAT CONTROL

MXZ-2A MXZ-4A80VA -[E2] MXZ-5A

The compressor is energized even while it is not operating.

This is to generate heat at the winding to improve the compressor's start-up condition.

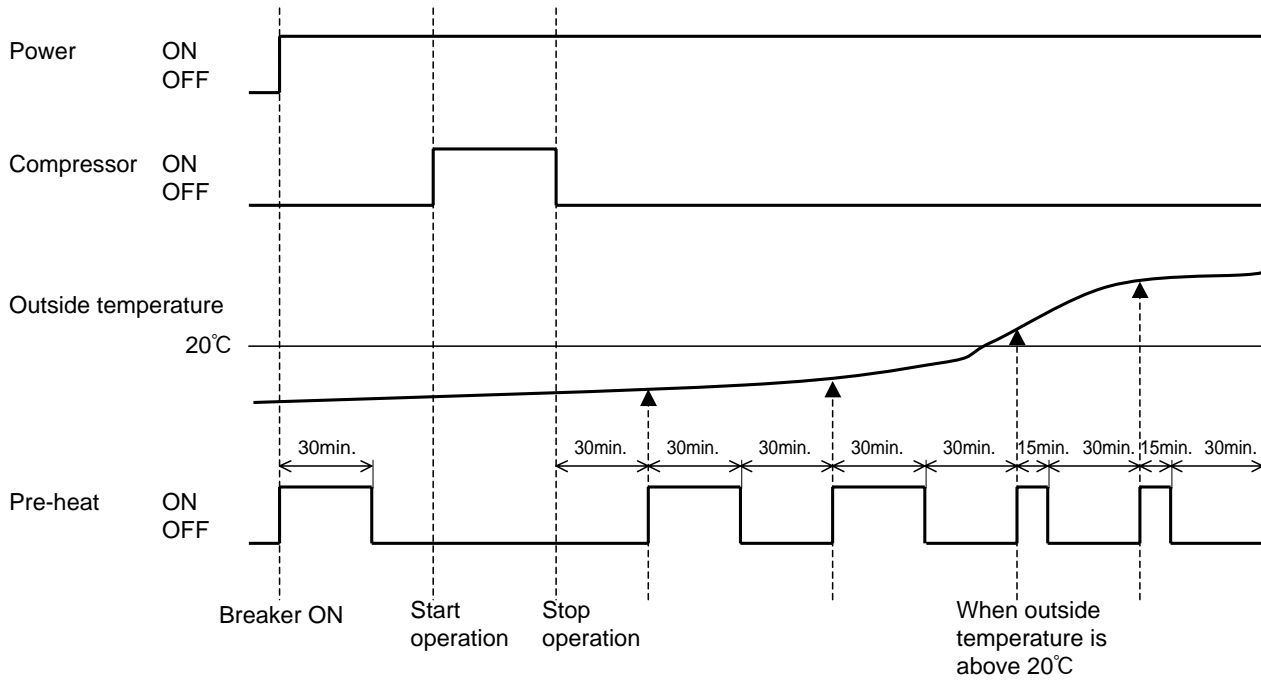

1. Pre-heat control is turned ON for 15 or 30 min* after the breaker is turned ON.
2. 30 min. after the unit is stopped, pre-heat control is turned ON for 15 or 30 min.* and turned OFF for 30 min. This is repeated as shown in the graph until the breaker is turned OFF.

* When outside temperature is 20°C or below , pre-heat control is ON for 30 min.
When outside temperature is 21°C or above, pre-heat control is ON for 15 min.

NOTE: When the unit is started with the remote controller, pre-heat control is turned OFF.
Compressor uses 50W when pre-heat control is turned ON.

12-9. COOL OPERATION

1. Thermostat control

Thermostat is ON or OFF by difference between room temperature and set temperature.

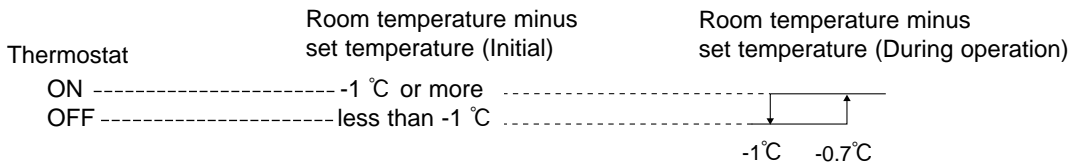

2. Coil frost prevention

The compressor operational frequency is controlled to prevent the indoor heat exchanger temperature from falling excessively.

Compressor is turned OFF for 5 minutes when temperature of indoor coil thermistor continues 3: or less for 5 minutes or more.



12-10. DRY OPERATION

1. Thermostat control

Thermostat is ON or OFF by difference between room temperature and set temperature.

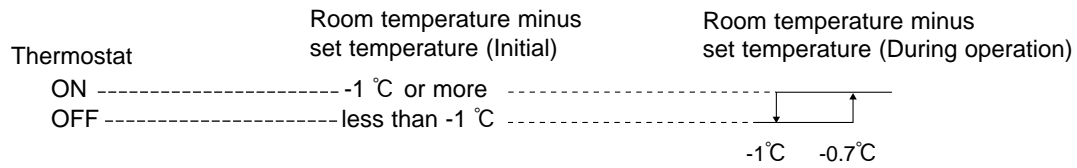

2. Coil frost prevention

Coil frost prevention is as same as COOL mode. (12-9.2.)

12-11. HEAT OPERATION

1. Thermostat control

Thermostat is ON or OFF by difference between room temperature and set temperature.

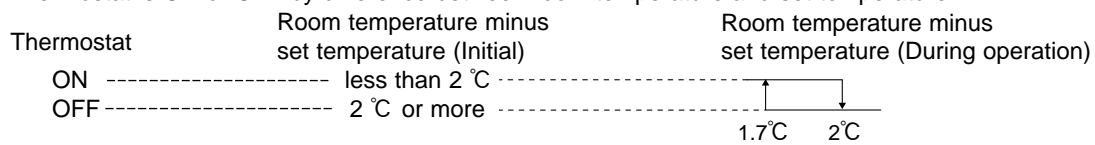

2. High pressure protection

In HEAT operation the indoor coil thermistor detects the temperature of the indoor heat exchanger. The compressor operational frequency is controlled to prevent the condensing pressure from increasing excessively.



HEAD OFFICE: TOKYO BLDG., 2-7-3, MARUNOUCHI, CHIYODA-KU, TOKYO 100-8310, JAPAN

© Copyright 2005 MITSUBISHI ELECTRIC ENGINEERING CO.,LTD

Distributed in Mar. 2007. No. OBT06 REVISED EDITION-D 7

Distributed in Oct. 2006. No. OBT06 REVISED EDITION-C 7

Distributed in Mar. 2006. No. OBT06 REVISED EDITION-B 7

Distributed in Aug. 2005. No. OBT06 REVISED EDITION-A 8

Distributed in May 2005. No.OBT06 8

Made in Japan

New publication, effective Mar. 2007
Specifications subject to change without notice.